

Road Transport (Vehicle Registration) Regulation 2007

[2007-522]



New South Wales

Status Information

Currency of version

Historical version for 30 June 2015 to 30 June 2015 (accessed 13 November 2024 at 0:12)

Legislation on this site is usually updated within 3 working days after a change to the legislation.

Provisions in force

The provisions displayed in this version of the legislation have all commenced.

Notes—

- **Does not include amendments by**
 - [Road Transport Legislation Amendment \(Fees, Penalty Levels and Charges\) Regulation 2015 \(225\)](#) (LW 22.5.2015) (not commenced — to commence on 1.7.2015)
 - [Statute Law \(Miscellaneous Provisions\) Act 2015 No 15](#) (not commenced — to commence on 8.7.2015)
- **Note**

The [Road Transport \(Vehicle Registration\) Regulation 2007](#) made under the [Road Transport \(Vehicle Registration\) Act 1997](#) is on and from 1.7.2013 taken to be a regulation made under the [Road Transport Act 2013](#). See clause 8 of Schedule 4 to the [Road Transport Act 2013 No 18](#).

Authorisation

This version of the legislation is compiled and maintained in a database of legislation by the Parliamentary Counsel's Office and published on the NSW legislation website, and is certified as the form of that legislation that is correct under section 45C of the [Interpretation Act 1987](#).

File last modified 30 June 2015

Road Transport (Vehicle Registration) Regulation 2007



New South Wales

Contents

Part 1 Preliminary	11
1 Name of Regulation	11
2 Commencement	11
3 Definitions	11
4 (Repealed)	11
Part 2 Registration process	11
Division 1 Eligibility for registration	11
5 Registered operator of registrable vehicle	11
6 Eligible vehicles	12
Division 2 Applications for registration	12
7 Who may apply for registration?	12
8 Form of application	12
9 Supporting evidence	13
10 Lodgment of application, supporting evidence and payment	14
11 Duration of registration	15
12 Determination of applications	15
13 Conditional registration	16
Division 3 The Register	17
14 Maintenance of the Registers	17

Division 3A Release of information by Authority	19
14A Release of information in Register to toll operators	19
14B Release of information of a personal nature.....	19
14C Release of information to Austroads.....	20
14D Release of information in Register to CTP insurers.....	20
14E Release of information for searches	20
14F Release of information in Register to Centrelink to verify concession entitlements	22
Division 4 Registration documents	22
15 Certificates of registration	22
16 Registration labels for certain registrable vehicles	23
16A Replacement of registration documents.....	25
Division 5 Number-plates	26
Subdivision 1 Interpretation	26
17 Definitions	26
18 Application of Division to trader’s plates	26
Subdivision 2 Issue of number-plates	26
19 Number-plates generally	26
20 Special number-plates	27
21 Auxiliary number-plates for bicycle and approved personal mobility device racks	28
22 Authority may alter distinguishing number of registration	29
22A Authority may alter number-plate design.....	29
Subdivision 3 Reservation, transfer and replacement of number-plates	30
23 Reservation of number-plates.....	30
24 Transfer of number-plates.....	30
25 Replacement of surrendered number-plates	30
Subdivision 4 Damaged, destroyed or missing number-plates	31
26 Damaged number-plates	31
27 Lost, stolen or destroyed number-plates	31

28 Recovery of lost or stolen number-plates	32
Subdivision 5 General	32
28A Return of number-plates.....	32
28B Special number-plate concession arrangements.....	32
28C Possession of number-plates	33
Division 6 Renewal of registration	33
29 Notice for renewal of registration	33
30 Renewal of registration.....	34
Part 3 Alteration of registration status	35
Division 1 General obligations of registered operators	35
31 Obligations of registered operators	35
Division 2 Transfer of registration	36
32 Obligations of disposers: provision of inspection reports	36
33 Obligations of disposers: application for transfer of registration and notification to Authority.....	37
34 Obligations of acquirers.....	38
35 Repossession and restoration	39
36 Registration of the transfer of vehicles and functions of the Authority	40
37 Transfer on death of registered operator	41
38 Partial transfer of light vehicle.....	42
Division 3 Expiry of registration	42
39 Expiry of registration	42
Division 4 Surrender and cancellation of registration	43
40 Surrender of registration by registered operator	43
41 Suspension or cancellation of registration by Authority	43
41A Suspension of registration for dimension requirement offence	45
42 Procedures for suspension and cancellation of registration.....	46
42A Cancellation or suspension of registration by court under Heavy Vehicle National Law.....	47
Part 4 Authorised and permitted uses of unregistered registrable vehicles	

.....	48
Division 1 Unregistered vehicle permits	48
43 Issue of unregistered vehicle permits.....	48
Division 2 Trader’s plates	49
44 Issue of trader’s plates	49
45 Use of vehicles with trader’s plates on road or road related area	49
46 Purposes for which trader’s plates may be used	49
47 Trader to keep and produce record.....	51
48 Questions regarding use of plate to be answered	51
49 Disposal or cessation of business	52
50 Return of trader’s plate	52
Division 3 Persons unaware of registration status	52
50A Vehicles being driven in the course of motor industry business.....	52
50B Vehicles being driven by persons unaware of registration status.....	52
Part 5 Vehicle standards	53
Division 1 General requirements	53
51 Applicable vehicle standards	53
52 Registrable vehicles to comply with vehicle standards specified in Schedule 2	53
Division 2 Standards and certifications	55
53 Compliance with vehicle standards	55
54 Non-complying and non-standard vehicles.....	56
55 Operations plates and certificates of approved operations	56
55A Modifications to registered light vehicles	56
55B Construction of or modification to registered vehicles	57
Division 3 Inspections	57
Subdivision 1 When vehicles may be inspected	57
56 Directed inspections	57
57 Periodic inspections	58

Subdivision 2 Authorised examiners and inspection stations	58
58 Examiner’s authorities.....	58
59 Proprietor’s authorities	60
60 Authority may issue rules for the purposes of this Subdivision	62
61 Books of inspection reports	62
62 Suspension or cancellation of examiner’s authorities and proprietor’s authorities	62
63 Committee of review	63
64 Notification of decisions by Authority	64
Division 4 Component identification numbers	65
65 Definitions	65
66 Allotment of component identification numbers.....	65
67 Altering component identification numbers of vehicle parts without authority	65
68 Change or replacement of vehicle part	66
69 Interference with component identification number.....	66
Division 5 Vehicle defect notices	67
70 Issue of defect notices and formal warnings	67
71 Recording, clearance and withdrawal of vehicle defect notices	69
Division 6 (Repealed)	70
Part 5A Certification of vehicles	70
Division 1 Preliminary	70
76AA Definitions.....	70
Division 2 Significantly modified vehicles	70
76AB Significant modifications to vehicles	70
76AC Modified vehicles not to be used unless certified.....	70
Division 3 Compliance certificates	71
76AD Compliance certificate may be issued	71
76AE Authority may cancel compliance certificate	72
76AF Person may drive vehicle for purpose of compliance certificate.....	72

Division 4 Licensing of certifiers	72
76AG Definition	72
76AH Applications with respect to licences	72
76AI Licences	73
76AJ Consultation before making certain decisions.....	74
76AK Immediate suspensions.....	74
76AL Record keeping requirements.....	75
76AM Insurance.....	75
76AN Offence of holding out.....	76
76AO Service of notices under Part.....	77
76AP Transitional provision—certificates issued under old scheme.....	77
Part 6 Charges, fees and refunds	77
Division 1 Preliminary	77
76A Definitions	77
76B (Repealed).....	77
Division 2 Calculation of registration charges for chargeable heavy vehicles	77
76C Annual registration charges for chargeable heavy vehicles	78
76D Calculation of refund of registration charges for heavy vehicles on cancellation of registration ..	78
76DA Refund of certain registration charges paid during 2012–2013 financial year	78
Division 3 Exemptions from registration charges for chargeable heavy vehicles	79
76E Exemption for eligible pensioners	79
76F Exemption for civil defence vehicles.....	79
76G Exemption for vehicles used for mine rescue work.....	79
76H Exemption for vehicles with trader’s plates	80
76I Exemption for vehicles exempted from registration	80
76J Exemptions granted by Minister	80
76JA Exemptions relating to certain types of converter dolly and small operators.....	80

Division 4 Miscellaneous	81
77 Fees.....	81
78 Refunds of fees.....	82
79 (Repealed).....	83
80 Exemption for eligible pensioners	83
81 Refund of number-plate fees	83
82, 83 (Repealed).....	83
Part 6A Written-off vehicles	83
Division 1 Preliminary	83
83A Definitions	83
83B Meaning of “written-off vehicle”	85
Division 2 Non-repairable damage	85
83C Non-repairable damage—vehicles other than motor bikes or trailers	85
83CA Non-repairable damage—motor bikes.....	87
83CB Non-repairable damage—trailers	87
Division 3 Authorisations to repair	88
83D Vehicles that are not eligible for the issue of authorisation to repair	88
83E Eligibility to apply for an authorisation to repair.....	88
83F Term of authorisations to repair.....	88
Division 4 Assessment of vehicles	89
83G Prescribed qualifications to carry out vehicle damage assessments.....	89
83H Standards of repairs and repair methods	89
83I Records about vehicle damage assessments	89
Division 5 Notifications about written-off vehicles	90
83J Notification of information about vehicles assessed as a total loss	90
83K Notification of information about vehicles not assessed as a total loss.....	90
83L Prescribed information about vehicles disposed of to auto-dismantler.....	91
83M Prescribed information about demolished or dismantled vehicles	91
Division 6 Records about other vehicles	92

83N Records required to be kept by insurers of information about certain vehicles assessed as not being total losses	92
Division 7 Written-off vehicle warning labels	92
83O Obligation to attach written-off vehicle warning labels	93
83P Content and form of written-off vehicle warning label	93
83Q Positioning of written-off vehicle warning label	93
83R Offence to alter, damage, destroy, remove or interfere with written-off vehicle warning label	93
Division 8 Certificates of compliance	93
83S Standards of repairs and repair methods	93
83T Certificates of compliance in relation to electronic control systems	94
83U Issue of certificates of compliance	94
83V Term of certificates of compliance	94
83W Records of certificates of compliance	94
Division 9 Special provisions for certain vehicles	95
83X Superficially-damaged motor bikes	95
83Y Vehicles returned to registered operator by insurer	95
83YA Hail-damaged vehicles	96
Division 10 Transitional provisions	96
83Z Existing repairable interstate written-off vehicles may be registered without authorisation to repair	97
83ZA Application to written-off vehicles on register before commencement date	97
83ZB Vehicles eligible for authorisation to repair before substitution of clause 83D	97
83ZC Relevant written-off hail-damaged vehicles taken to be former written-off vehicles	97
83ZD Transitional provision: non-repairable damage	97
Part 7 Miscellaneous	98
Division 1 Offences	98
84 Use of vehicle offences	98
85 Number-plate and registration certificate and label offences	98
86 Notification offences	99

Division 2 Disposal of forfeited vehicles	100
87 How forfeited vehicles may be disposed of under section 79 of the Act	100
88 Proceeds of sales of vehicles seized under section 79 of the Act	100
Division 3 Other provisions	101
88A (Repealed)	101
89 More than one person recorded as registered operator of light vehicle	101
90 Application of Road Transport (Mass, Loading and Access) Regulation 2005.....	101
91 Special provisions relating to boat trailers	101
91A Photographic evidence of unauthorised vehicle use: section 135 of Act.....	102
92, 93 (Repealed)	102
94 Savings and transitional provisions	102
95 (Repealed)	103
Schedule 1 Application of Chapter 4 of Act and Regulation	103
Schedule 2 Vehicle standards	111
Schedule 3 Fees	184
Schedule 4 Registration charges for chargeable heavy vehicles	188
Dictionary	208

Road Transport (Vehicle Registration) Regulation 2007



New South Wales

Part 1 Preliminary

1 Name of Regulation

This Regulation is the *Road Transport (Vehicle Registration) Regulation 2007*.

2 Commencement

This Regulation commences on 1 November 2007.

3 Definitions

- (1) Expressions used in this Regulation (or in any particular provision of this Regulation) that are defined in the Dictionary at the end of the Regulation have the meanings set out in the Dictionary.
- (2) Notes included in this Regulation do not form part of this Regulation.

4 (Repealed)

Part 2 Registration process

Division 1 Eligibility for registration

5 Registered operator of registrable vehicle

- (1) A person is eligible to be a registered operator of a registrable vehicle if that person is:
 - (a) an individual who has attained the requisite age, or
 - (b) a corporation.
- (2) Despite subclause (1), the Authority may record in the Register that an individual is a registered operator of a registrable vehicle even though the individual has not attained the requisite age if it is satisfied that it is appropriate to do so. Any such individual is, for the purposes of this Regulation (including renewal of registration),

taken to have been eligible to be a registered operator of the vehicle.

(3) In this clause, **requisite age** means 16 years of age.

6 Eligible vehicles

(1) A registrable vehicle is eligible to be registered without conditions if:

(a) the vehicle complies with the applicable vehicle standards for the vehicle, and

(b) the requirements of any applicable third party insurance legislation and duty legislation are complied with in respect of the vehicle, and

(c) the vehicle is owned by, or is under the management of, a person who is eligible to be a registered operator of the vehicle.

(2) Despite subclause (1), the Authority may refuse to register a registrable vehicle if the Authority is satisfied that:

(a) the vehicle has been registered in another State or a Territory, and

(b) the registration in that State or Territory has been cancelled or suspended, and

(c) the reasons for the cancellation or suspension still exist.

Division 2 Applications for registration

7 Who may apply for registration?

(1) Application for registration of a registrable vehicle may be made by a person who is eligible to be a registered operator of a registrable vehicle or the agent of such a person.

(2)-(4) (Repealed)

(5) If it appears to the Authority that an application for registration of a registrable vehicle is made by an agent, the Authority must not grant the application unless the agent produces:

(a) evidence of the agent's identity in a form acceptable to the Authority, and

(b) a document evidencing the authority of the agent to act as agent for each person seeking registration as a registered operator.

8 Form of application

(1) An application for registration of a registrable vehicle must be in a form approved by the Authority.

(2) The Authority may require the applicant to provide to the Authority information about:

- (a) the identity and home address of each person seeking registration (or on whose behalf an agent is seeking registration) as a registered operator of the registrable vehicle, and
- (b) an address for the service of notices, and
- (c) the proposed garage address of the vehicle, and
- (d) fees, premiums, imposts and similar amounts relating to the vehicle under third party insurance legislation and duty legislation that have been paid or that are payable, and
- (e) any other matter relevant to the decision whether to register the vehicle or to record a person on the Register as a registered operator of the vehicle.

Note—

Section 4 of the Act defines **home address**, in relation to a body corporate that has a registered office in Australia, to mean the address of its registered office.

9 Supporting evidence

- (1) The Authority may request an applicant for registration of a registrable vehicle to submit evidence, in a form approved by the Authority, verifying:
 - (a) the identity of any person seeking registration as a registered operator of the vehicle, and
 - (b) the means by which the vehicle came into the ownership, or under the management, of that person, and
 - (c) the proposed garage address of the vehicle, and
 - (d) that the vehicle complies with the applicable vehicle standards for the vehicle, and
 - (e) the acceptability of non-standard or non-complying vehicles, and
 - (f) any other information specified by the Authority in the application form.
- (2) In addition to the evidence that may be required under subclause (1), the Authority may request an applicant for registration of a registrable vehicle that has a vehicle identifier that is the same as the vehicle identifier of a vehicle recorded on the NSW written-off vehicles register to submit any of the following evidence:
 - (a) a valid receipt for any repairs made to the vehicle,
 - (b) if the vehicle was repaired using a part of another vehicle—a valid receipt for the purchase of that part, being a receipt that contains the vehicle identifier of the other vehicle,

(c) any other information specified by the Authority.

(3) In this clause:

valid receipt means a receipt:

(a) that is an original document, and

(b) that contains the name and Australian Business Number of the relevant repairer or trader, and

(c) that is dated, and

(d) that contains such other information as may be required by the Authority.

10 Lodgment of application, supporting evidence and payment

(1) An applicant for registration of a registrable vehicle must submit to the Authority:

(a) the application for registration, and

(b) any supporting evidence required by the Authority, and

(c) payment or evidence of payment of any applicable fees, premiums, imposts and similar amounts relating to the vehicle under third party insurance legislation and duty legislation and the relevant registration charge applicable to the vehicle and the applicable fee for registration of the vehicle.

(2) In addition to any applicable fee for the registration of the vehicle, the applicant must also submit to the Authority payment of any applicable fee for the issue of number-plates.

(3) An eligible pensioner is not required to pay any applicable fee for the registration of a vehicle.

(4) An applicant is not required to pay any applicable fee in relation to a vehicle if the Authority is of the opinion that:

(a) the applicant was the registered operator of a registrable vehicle that was destroyed or rendered beyond repair as a consequence of damage caused to the vehicle by an occurrence that gave rise to an emergency, and

(b) the vehicle to which the application relates is a replacement for the damaged vehicle, and

(c) in the circumstances of the case it would be inappropriate to require payment of the fee.

(5) In this clause:

emergency has the same meaning as it has in the *State Emergency and Rescue Management Act 1989*.

Note—

Emergency is defined in the *State Emergency and Rescue Management Act 1989* to mean an emergency due to an actual or imminent occurrence (such as fire, flood, storm, earthquake, explosion, terrorist act, accident, epidemic or warlike action) which:

- (a) endangers, or threatens to endanger, the safety or health of persons or animals in the State, or
 - (b) destroys or damages, or threatens to destroy or damage, property in the State,
- being an emergency which requires a significant and co-ordinated response.

11 Duration of registration

- (1) An applicant for registration of a registrable vehicle must nominate one of the following periods:
 - (a) if the applicant is seeking to register a registrable vehicle (other than a seasonal vehicle):
 - (i) 3 months, or
 - (ii) 6 months, or
 - (iii) one year,
 - (b) (Repealed)
 - (c) if the applicant is seeking to register a seasonal vehicle—the period for which registration is sought.
- (2) Despite subclause (1), an applicant may nominate, and the Authority may approve, a different period of registration for any light vehicle if:
 - (a) the Authority considers that it is necessary to do so to achieve a common registration expiry date for vehicles in a fleet, or
 - (b) the Authority considers it appropriate to do so in the circumstances.

12 Determination of applications

- (1) The Authority may refuse an application for registration of a registrable vehicle if:
 - (a) the vehicle is not an eligible vehicle, or
 - (b) a provision of this Regulation prevents approval of the application, or
 - (c) the applicant has not complied with a provision of the Act or this Regulation in relation to the registration of the vehicle (including any requirement to submit or pay any fee), or

- (d) the Authority reasonably believes that:
 - (i) the vehicle or a part of the vehicle is or may be stolen, or
 - (ii) information given in the application for registration is false or misleading, or
 - (iii) there are unpaid fines or pecuniary penalties arising out of the use of the vehicle in Australia, or
 - (iv) the vehicle is being used for an unlawful purpose, or
 - (e) the Authority is not satisfied that the vehicle's garage address is in this State, or
 - (f) the applicant fails to comply with the requirements of or under a law in force in this State relating to certificates of roadworthiness for, or inspection of, registrable vehicles, or
 - (f1) a court has made an order under section 598 (3) of the Heavy Vehicle National Law in relation to the heavy vehicle for a stated period and the period has not expired, or
 - (g) the Authority is, for any reason whatsoever, of the opinion that the applicant is not a fit and proper person to be the holder of the registration for the vehicle.
- (2) If the Authority approves an application, it must register the registrable vehicle in the name of each person seeking registration (or on whose behalf registration is sought) as a registered operator.

13 Conditional registration

- (1) The Authority may register a registrable vehicle conditionally if:
 - (a) the vehicle does not comply with an applicable vehicle standard for the vehicle, or
 - (b) the Authority considers it appropriate for some other reason to register the vehicle conditionally.
- (2) The Authority may refuse to register a registrable vehicle conditionally under subclause (1) (a) if the vehicle does not bear an operations plate or identification plate relating to the vehicle, or a certificate of approved operations has not been issued or accepted by the Authority in respect of the vehicle.
- (3) In determining the conditions to be imposed on the registration of a registrable vehicle that does not comply with an applicable vehicle standard for the vehicle, the Authority must take into account the nature and extent of any failure of the vehicle to meet the requirements of the applicable vehicle standards for the vehicle.
- (4) The Authority may at any time vary any conditions that it imposes on the registration of a registrable vehicle.

- (5) The Authority must notify a registered operator in writing of the conditions, or any variation of the conditions, applicable to the conditional registration of a registrable vehicle. Any such conditions or variation of conditions have effect only on the notification of the registered operator.

Division 3 The Register

14 Maintenance of the Registers

- (1) **General matters to be recorded in respect of vehicle** If the Authority registers a registrable vehicle it must record in the Register, in respect of the vehicle:
- (a) if the vehicle is not a transitional registrable vehicle (within the meaning of section 64 of the Act)—the name, home address and the address for the service of notices (if any) of the registered operator, and
 - (a1) if the vehicle is a transitional registrable vehicle (within the meaning of section 64 of the Act)—the name, home address and the address for the service of notices (if any) of each of the registered operators.
 - (b) the identification details of the vehicle, and
 - (c) the vehicle's garage address, and
 - (d) (Repealed)
 - (e) the expiry date of the registration, and
 - (f) if the vehicle is conditionally registered—the conditions of registration, and
 - (g) the vehicle's GVM (if applicable to the vehicle concerned), and
 - (h) the vehicle's GCM (if applicable to the vehicle concerned), and
 - (i) in the case of a heavy vehicle—the vehicle's nominated configuration, and
 - (j) the name, if appropriate, of any insurer providing third party insurance in respect of the vehicle.

Note—

Section 4 of the Act defines **home address**, in relation to a body corporate that has a registered office in Australia, to mean the address of its registered office.

- (2) **Other matters that may be recorded** The Authority may record in the Register other information for:
- (a) the purposes of the Act and this Regulation, or
 - (b) the purposes of another Act, or

(c) other purposes that the Authority considers to be appropriate.

(2A) The Authority must record details of any finding of guilt under section 243 of the Act in the Register or another register kept by the Authority.

(3) **Changes in description or configuration to be recorded** The Authority must record in the Register any change in the registrable vehicle's description or nominated configuration that is recorded in the Register of which it has been notified under the Act or this Regulation unless the Authority is satisfied that the information is false.

(4) **Evidence may be required to verify description and configuration changes** The Authority may require evidence in a form acceptable to the Authority verifying that the changes referred to in subclause (3) are correct.

(5) **Register to record information over previous 24 months** The Authority must ensure that the Register contains details of all registrable vehicles that are currently registered, or that have been registered within the previous 24 months.

(6) **Requests for Register searches** A registered operator of a registrable vehicle is entitled to request a search of the Register or other register kept under subclause (2A), and to obtain a certificate as to any matter (subject to subclause (7)) appearing in the Register or other register kept under subclause (2A), in respect of the vehicle, on payment of any applicable fee for the search.

Note—

Personal information contained in the Register or other register kept under subclause (2A) is subject to the [Privacy and Personal Information Protection Act 1998](#).

(7) **Recording of dealing restrictions** Without limiting subclause (2), the Authority may also record in the Register information for the purpose of identifying a dealing restriction with respect to a registrable vehicle.

(8) **Effect of recorded dealing restrictions** Despite any other provision of this Regulation, if a dealing with respect to a registrable vehicle contravenes a dealing restriction recorded in the Register in respect of the vehicle, the Authority may:

(a) if the dealing requires the approval of the Authority—refuse to approve the dealing, and

(b) refuse to record details of the dealing in the Register, and

(c) refuse to exercise any other function of the Authority in connection with that dealing.

(9) **Definitions** In this clause:

dealing, in relation to a registrable vehicle, means:

(a) the registration of the vehicle, or

- (b) the renewal of the registration of the vehicle, or
- (c) the transfer of the registration of the vehicle.

dealing restriction, in relation to a registrable vehicle, means any restriction on a dealing with respect to the vehicle that the Authority has determined should apply to the vehicle.

Division 3A Release of information by Authority

14A Release of information in Register to toll operators

- (1) The Authority may enter into an agreement with a toll operator (a **registration information disclosure agreement**) that provides for the release to the toll operator of registration information with respect to a registrable vehicle.
- (2) The Authority must consult with the Privacy Commissioner before entering into a registration information disclosure agreement.
- (3) The Authority is authorised to release registration information in the Register in accordance with a registration information disclosure agreement.
- (4) A registration information disclosure agreement may provide for the payment of fees by a toll operator to the Authority in connection with the agreement, including fees for the release of information in accordance with the agreement.
- (5) In this clause:

registration information, with respect to a registrable vehicle, means the following information recorded in the Register:

- (a) the name, residential address and address for the service of notices (if any) of any registered operator of the vehicle, and
- (b) the identification details of the vehicle.

toll operator means a toll operator under the [Roads Act 1993](#), other than the Authority.

14B Release of information of a personal nature

- (1) Section 64 (3) of the Act does not prevent the release of information contained in the Register that is of a personal nature unless the privacy legislation would also prevent the particular release.
- (2) In this clause:

privacy legislation means the [Privacy and Personal Information Protection Act 1998](#) and the [Health Records and Information Privacy Act 2002](#) and any regulations or

codes of practice under either of those Acts.

14C Release of information to Austroads

- (1) The Authority is authorised to release any information in the Register to Austroads for the purposes of the National Exchange of Vehicle and Driver Information System.
- (2) In this clause:

Austroads means Austroads Limited (ACN 136 812 390), and includes any successor to or continuation of that company.

14D Release of information in Register to CTP insurers

- (1) The Authority may enter into an agreement with a CTP insurer (a **CTP insurer registration information disclosure agreement**) that provides for the release to the CTP insurer of the relevant information about a registrable vehicle in connection with the issue by that CTP insurer of a third-party policy in respect of the vehicle (including the provision of a quote for the issue of such a policy).
- (2) The Authority is authorised to release relevant information in accordance with a CTP insurer registration information disclosure agreement.
- (3) A CTP insurer registration information disclosure agreement may provide for the payment of fees by a CTP insurer to the Authority in connection with the agreement, including fees for the release of relevant information in accordance with the agreement.
- (4) In this clause:

CTP insurer means a licensed insurer under the [Motor Accidents Compensation Act 1999](#).

relevant information, with respect to a registered vehicle, means the following information:

- (a) any information recorded on the Register,
- (b) the date of birth of any registered operator or proposed registered operator of the vehicle.

third-party policy means a third-party policy of insurance as defined under the [Motor Accidents Compensation Act 1999](#).

14E Release of information for searches

- (1) The Authority is authorised to release vehicle information as part of the operation of a service that allows any person to conduct a search of information about the registration of a motor vehicle, whether or not for payment, including, but not limited

to:

- (a) the online service known as “Free registration check report” provided by the Authority,
- (b) the computer program designed to run on a smartphone or other mobile device known as the “NSW Rego App”,
- (c) the online service known as the “Vehicle history report” provided by the Authority.

(2) In this clause:

CTP insurer means a licensed insurer under the [Motor Accidents Compensation Act 1999](#).

vehicle information, with respect to a registrable vehicle, means the following information:

- (a) the plate number of the vehicle,
- (b) the month and year of manufacture of the vehicle,
- (c) the colour of the vehicle,
- (d) the make and model of the vehicle,
- (e) the variant of the vehicle,
- (f) the shape of the vehicle,
- (g) the last 4 characters of the vehicle identification number or chassis number of the vehicle,
- (h) the tare weight of the vehicle,
- (i) the gross vehicle mass of the vehicle,
- (j) the registration status of the vehicle (that is, whether it is current, cancelled or suspended),
- (k) the date on which the registration of the vehicle will expire,
- (l) whether a registration concession applies to the vehicle,
- (m) whether a registration restriction applies to the vehicle,
- (n) the date of first registration of the vehicle in New South Wales,
- (o) the written-off vehicle status of the vehicle,
- (p) the stolen vehicle status of the vehicle,

- (q) the odometer reading of the vehicle,
- (r) the number of current and previous New South Wales registered operators of the vehicle,
- (s) the registration usage history, including the usage type and period of use of the vehicle,
- (t) the last 4 characters of the engine number of the vehicle,
- (u) the third-party policy of insurance (as defined under the *Motor Accidents Compensation Act 1999*) applying to the vehicle and its end date,
- (v) the name of the CTP insurer of the vehicle,
- (w) the code of the CTP insurer of the vehicle.

14F Release of information in Register to Centrelink to verify concession entitlements

- (1) The Authority is authorised to release to Centrelink the relevant details of the registered operator of a registrable vehicle, or a person who has applied to be the registered operator of a registrable vehicle, for the purposes only of verifying whether or not the registered operator or proposed registered operator is eligible for a concession.
- (2) In this clause:

Centrelink includes any Commonwealth body that takes over the function of Centrelink.

relevant details of a person means the following details:

- (a) the person's name,
- (b) the person's date of birth,
- (c) the customer reference number assigned to the person by Centrelink or the Commonwealth Department of Veterans' Affairs.

Division 4 Registration documents

15 Certificates of registration

- (1) If the Authority registers a registrable vehicle, the Authority must issue to the applicant a certificate of registration for the vehicle that includes:
 - (a) the name of each registered operator, and
 - (b) the address (if any) for the service of notices on a registered operator of the vehicle, and

- (c) the garage address of the vehicle, and
 - (d) the registration number of the vehicle, and
 - (e) the make of the vehicle, and
 - (f) the vehicle's VIN or, if there is no VIN, any chassis number and engine number of the vehicle, and
 - (g) the vehicle's GVM (if applicable to the vehicle concerned), and
 - (h) the vehicle's GCM (if applicable to the vehicle concerned), and
 - (i) in the case of a heavy vehicle—the applicable charging category for the vehicle for the purposes of Schedule 2 to the Act, and
 - (j) in the case of a light vehicle—the applicable motor vehicle tax for the vehicle under the *Motor Vehicles Taxation Act 1988*, and
 - (k) the expiry date of the registration, and
 - (l) if the vehicle is conditionally registered—the conditions to which registration of the vehicle is subject, and
 - (m) if the vehicle was first recorded on the register of written-off vehicles kept under Part 2AA of the former *Road Transport (Vehicle Registration) Act 1997* or on the NSW written-off vehicles register at some time on or after 31 January 2011—the fact that the vehicle is recorded on the NSW written-off vehicles register.
- (2) The Authority may also include in a certificate of registration such other information as the Authority considers is appropriate.
- (3) On payment of any applicable fee, the Authority may issue a replacement certificate of registration to the person in whose name the certificate was issued if the Authority is satisfied that the original certificate is lost, stolen, damaged or destroyed.
- (4) A certificate of registration and any renewal of such a certificate issued under this Part is to bear the imprint of the Authority's cash register or such other endorsement as may be approved by the Authority recording the payment of any fee or other money payable under the Act or any other Act or this Regulation in connection with the registration or renewal.
- (5) Subclause (1) (m) does not apply to a certificate of registration issued before 31 January 2013.

16 Registration labels for certain registrable vehicles

- (1) If the Authority registers a heavy vehicle, or conditionally registers any registrable vehicle, it must issue a registration label.

(2) A registration label:

- (a) issued in respect of a motor vehicle (other than a motor vehicle referred to in paragraph (b)) must include:
 - (i) the registration number of the vehicle, and
 - (ii) its make, and
 - (iii) its model or body type (whichever is the more descriptive), and
 - (iv) its VIN or, if there is no VIN, any chassis number and engine number, and
 - (v) the expiry date of the vehicle's registration, and
 - (vi) if the vehicle is conditionally registered—a code indicating that the vehicle is conditionally registered, and
 - (vii) the vehicle's GVM (if applicable to the vehicle concerned), and
 - (viii) the vehicle's GCM (if applicable to the vehicle concerned), and
 - (ix) if the vehicle is a heavy vehicle—the applicable charging category for the vehicle for the purposes of Part 2A of the Act in coded form, or
- (b) issued in respect of a trailer or a motor vehicle without a windscreen or fixed windows must be in a form approved by the Authority.

Note—

In relation to subclause (2) (a) (vi), a registered operator will receive full written explanation of the conditions applying to the vehicle when the registration label is issued.

In relation to subclause (2) (a) (ix), a list of codes is available from the Authority.

(3) A registration label must be affixed:

- (a) in the case of a motor vehicle fitted with a windscreen or fixed windows:
 - (i) to the lower left (or near side) portion of the front windscreen, or
 - (ii) to any fixed window on the left (or near) side of the vehicle, and
- (b) in the case of a caravan or other trailer:
 - (i) on or adjacent to the vehicle's number-plate in such a manner that the characters on the number-plate are not obscured, or
 - (ii) if the vehicle has a fixed rear window or a hinged rear window that is to be closed when the caravan or other trailer is being towed—to that window, in a location as close as possible to the vehicle's number-plate, and

- (c) in any other case—on or adjacent to the vehicle’s rear number-plate in such a manner that the characters on the number-plate are not obscured.
- (4) Despite subclause (3), the registration label must be affixed so that the information on the label is readable from the outside of the vehicle.
- (5) Despite subclause (1), the Authority is not required to issue a registration label in respect of a registrable vehicle that is operated by a State or Territory or the Commonwealth or by an authority of a State or Territory or the Commonwealth.
- (6) On payment of any applicable fee, the Authority may issue a replacement registration label to the person in whose name a registrable vehicle is registered if the Authority is satisfied that the original registration label is lost, stolen, damaged or destroyed.

16A Replacement of registration documents

- (1) The Authority may, at any time, issue a replacement certificate of registration for a registered vehicle if the Authority is satisfied that the expiry date of the vehicle’s registration recorded on the Register is different to the expiry date included in the certificate of registration.

Note—

Clause 15 (3) provides for the replacement of a certificate of registration that has been lost, stolen, damaged or destroyed on the payment of the applicable fee.

- (1A) The Authority may, at any time, issue a replacement registration label for a registered vehicle that the Authority is required to issue a registration label in respect of if the Authority is satisfied that the expiry date of the vehicle’s registration recorded on the Register is different to the expiry date included in the registration label.

Note—

Clause 16 (6) provides for the replacement of a registration label that has been lost, stolen, damaged or destroyed on the payment of the applicable fee.

- (2) If the Authority issues a new certificate of registration or registration label under this clause, the registered operator of the vehicle must:
 - (a) destroy the certificate of registration or registration label, or both, that is or are being replaced, or
 - (b) if required to do so by written notice from the Authority, return the certificate of registration or registration label, or both, to the Authority (or an agent nominated by the Authority) before the date specified in the notice for that purpose.

Maximum penalty: 20 penalty units.

- (3) Despite subclause (2), a registered operator is not required to return to the Authority a certificate of registration or registration label that has been destroyed before the notice was issued under subclause (2) (b).

Division 5 Number-plates

Subdivision 1 Interpretation

17 Definitions

In this Division:

number includes a letter of the alphabet.

number-plate means a number-plate issued under this Regulation.

plate holder, in relation to a number-plate, means:

- (a) in the case of a trader's plate—the trader to whom the trader's plate has been issued, or
- (b) in the case of a special number-plate—the person to whom the special number-plate is issued pursuant to the special number-plate arrangements referred to in clause 20, or
- (c) in the case of any other number-plate—each registered operator of the registrable vehicle in respect of which the number-plate has been issued.

vehicle number-plate means a number-plate other than an auxiliary number-plate.

18 Application of Division to trader's plates

This Division (except Subdivision 4) does not apply to trader's plates.

Note—

Division 2 of Part 4 provides for the issue and use of trader's plates.

Subdivision 2 Issue of number-plates

19 Number-plates generally

- (1) If the Authority registers a registrable vehicle it must assign a distinguishing registration number to the vehicle.
- (2) The Authority must, on payment of the applicable fee for the issue of a vehicle number-plate or number-plates, issue:
 - (a) for each motor vehicle registered by the Authority (other than a motor vehicle referred to in paragraph (b) or (c))—2 vehicle number-plates bearing the registration number assigned to that motor vehicle, and
 - (b) for each motor bike or trailer registered by the Authority—at least one vehicle number-plate bearing the registration number assigned to that motor bike or trailer, and

(c) for each other registrable vehicle registered by the Authority—such number of vehicle number-plates as the Authority considers appropriate.

(3) A vehicle number-plate is to conform to such specifications as the Authority determines and must display the matter “NSW” or the words “New South Wales”, and such other words or matter as may be determined:

(a) by the Authority with the consent of the Minister in the case of standard number-plates, or

(b) by the Authority in the case of special number-plates.

20 Special number-plates

(1) The Authority may issue special number-plates to a person pursuant to arrangements determined by the Authority (referred to in this Division as the ***special number-plate arrangements***).

(2) Special number-plates may be issued to a person for a motor vehicle registered by the Authority (to display the distinguishing registration number assigned to the vehicle) or independently of vehicle registration. Special number-plates issued independently of vehicle registration must be kept in the possession of the Authority, unless the Authority otherwise determines in a particular case or class of cases.

(3) The Authority may set the fees, charges and consideration to be paid for or in connection with the issue of special number-plates and other services provided by the Authority in connection with the issue of special number-plates. However, any such fee, charge or consideration cannot be set in relation to a matter for which a fee is prescribed by Schedule 3.

(4) The special number-plate arrangements can include provision for the following:

(a) the terms and conditions under which special number-plates are issued and the rights and obligations of plate holders in respect of special number-plates,

(b) the arrangements under which special number-plates issued independently of vehicle registration are to be held in the possession of the Authority (including requirements for the payment of additional fees and charges in connection with that service),

(c) providing for the consideration to be paid for or in connection with the issue of a special number-plate to be determined by auction, tender or other competitive process,

(d) the issue of replica or souvenir versions of special number-plates,

(e) requiring an agreement to be entered into for the issue of special number-plates (being an agreement between the Authority and a person for or in connection with

the issue to the person of special number-plates).

- (5) The required agreement for the issue of special number-plates can include provision for the following:
 - (a) the terms and conditions under which a special number-plate is issued and the rights and obligations of the plate holder in respect of a special number-plate,
 - (b) requiring payment of the fees, charges and consideration that are payable under the special number-plate arrangements for or in connection with the issue of a special number-plate,
 - (c) such other matters in connection with special number-plates as the Authority considers appropriate.
- (6) The requirements of the special number-plate arrangements are in addition to the other requirements of this Division relating to the issue of number-plates.
- (7) In this clause, **issue** a number-plate includes allocate, set aside, reserve, transfer and replace a number-plate.

21 Auxiliary number-plates for bicycle and approved personal mobility device racks

- (1) The Authority may on payment of any applicable fee issue a number-plate (referred to in this Division as an **auxiliary number-plate**) for use on a registrable vehicle (in addition to the vehicle number-plates) by being placed on apparatus attached to the vehicle for use in transporting a bicycle or other personal mobility device approved by the Authority for the purposes of this clause.
- (2) An auxiliary number-plate is to have the same distinguishing number as the registration of the registrable vehicle on which it is to be used.
- (3) An auxiliary number-plate cannot be issued for use on a motor bike or motor trike.
- (4) An auxiliary number-plate is to conform to such specifications as the Authority determines and must display the matter "NSW" or the words "New South Wales", and such other words or matter as may be determined:
 - (a) by the Authority with the consent of the Minister in the case of an auxiliary number-plate that is a standard number-plate, or
 - (b) by the Authority in the case of an auxiliary number-plate that is a special number-plate.
- (5) For the purposes of this Regulation:
 - (a) an auxiliary number-plate is a number-plate for the purposes of this Regulation and is taken to be issued for use on a motor vehicle, and

(b) an auxiliary number-plate displayed, in accordance with this Regulation, on apparatus attached to a motor vehicle for use in transporting a bicycle or other approved personal mobility device is taken to be placed on the motor vehicle concerned.

(6) An auxiliary number-plate displayed on a motor vehicle must be illuminated, at all times when the vehicle is driven between the hours of sunset and sunrise, with a white light so as to render visible at a distance of 20 metres the distinguishing number on the plate.

22 Authority may alter distinguishing number of registration

(1) The Authority may at any time alter the distinguishing number of the registration of a registrable vehicle or of a number-plate allocated, reserved or set aside by the Authority.

(2) (Repealed)

(3) Without limiting subclause (1), the Authority may alter the distinguishing number of a registrable vehicle if the Authority considers that:

(a) there is an error of any kind in the vehicle number-plate issued for the vehicle, or

(b) there has been an error of any kind in the issuing of a vehicle number-plate for the vehicle.

(4) On or before altering the distinguishing number of the registration of a registrable vehicle under this clause, the Authority must give written notice to each registered operator of the vehicle requiring the registered operator to return to the Authority, within such period as is specified in the notice, any number-plate issued in respect of the vehicle.

(5) A registered operator of a registrable vehicle must comply with any notice given to the registered operator under this clause.

Maximum penalty: 20 penalty units.

(6) On receipt of a number-plate returned in accordance with the requirements of a notice given under this clause, the Authority is to issue to a registered operator of the registrable vehicle concerned a replacement number-plate bearing the distinguishing number, as altered, of the registration of the vehicle for each number-plate that is returned.

22A Authority may alter number-plate design

(1) The Authority may at any time alter the design of a number-plate issued by the Authority. The **design** of a number-plate includes the colour, layout, style and other characteristics of the appearance of a number-plate.

- (2) The Authority may give written notice to each registered operator of a vehicle requiring the registered operator to return to the Authority, within the period specified in the notice, any number-plate issued in respect of the vehicle that the Authority has decided to alter the design of.
- (3) A registered operator of a vehicle must comply with any notice given to the registered operator under this clause.
Maximum penalty: 20 penalty units.
- (4) The Authority alters the design of a number-plate by issuing a replacement number-plate with the altered design.
- (5) In this clause, **issue** a number-plate includes allocate, set aside and reserve a number-plate.

Subdivision 3 Reservation, transfer and replacement of number-plates

23 Reservation of number-plates

The Authority may reserve a number-plate (or the distinguishing number for a number-plate) on payment of any applicable fee.

24 Transfer of number-plates

- (1) The Authority may transfer number-plates from one vehicle to another on payment of any applicable fee.
- (2) The Authority may transfer the reservation of a number-plate (or the distinguishing number for a number-plate) on payment of any applicable fee.

25 Replacement of surrendered number-plates

- (1) The Authority may on payment of any applicable fee issue a number-plate to replace an existing number-plate.
- (2) The content and style of a replacement number-plate may be the same as or different from the content and style of the existing number-plate.
- (3) If a replacement number-plate is issued for a registrable vehicle before an existing number-plate for the vehicle is surrendered, a registered operator of the vehicle must surrender any existing number-plate to the Authority within 14 days after the replacement number-plate is issued.

Maximum penalty: 20 penalty units.

Subdivision 4 Damaged, destroyed or missing number-plates

26 Damaged number-plates

- (1) The plate holder of a number-plate that has become damaged must surrender the damaged number-plate to the Authority as soon as reasonably practicable for replacement under clause 25.
- (2) The plate holder must at the same time also surrender any other number-plate with the same distinguishing number, unless the Authority otherwise approves in a particular case.

Maximum penalty: 20 penalty units.

27 Lost, stolen or destroyed number-plates

- (1) If any vehicle number-plate is lost, stolen or destroyed, a plate holder must, as soon as is practicable after discovering the loss, theft or destruction:
 - (a) give written notification of the loss, theft or destruction to the Authority, and
 - (b) deliver to the Authority any other number-plate with the same number unless it too has been lost, stolen or destroyed.

Maximum penalty: 20 penalty units.

- (2) If an auxiliary number-plate is lost, stolen or destroyed, the plate holder must, as soon as practicable after discovering the loss, theft or destruction, notify the Authority in writing accordingly.
- (3) The Authority may request any such plate holder:
 - (a) to forward evidence, in a form acceptable to the Authority, verifying the loss, theft or destruction of the number-plate and stating the circumstances connected with it, and
 - (b) if a vehicle number-plate is lost, stolen or destroyed—to pay any applicable fee for replacing a lost, stolen or destroyed number-plate.
- (4) The Authority may issue a new number-plate under clause 25 to replace a number-plate that has been lost, stolen or destroyed.
- (5) When the Authority issues a new number-plate to replace a number-plate that has been lost, stolen or destroyed, the new number plate must:
 - (a) in the case of a vehicle number-plate—have a distinguishing number that is different from that of the number-plate it replaces, or
 - (b) in the case of an auxiliary number-plate—have the same number as the number-

plate it replaces,

unless the Authority otherwise approves in a particular case.

28 Recovery of lost or stolen number-plates

A person who recovers a lost or stolen number-plate must, as soon as is practicable after recovering the number-plate, give notification of the recovery to the Authority and, unless otherwise directed by the Authority, must also deliver the recovered number-plate to the Authority.

Maximum penalty: 20 penalty units.

Subdivision 5 General

28A Return of number-plates

- (1) The Authority may, by written notice to a person who has possession of a number-plate issued by the Authority, direct the person to return the number-plate to the Authority.
- (2) A person must comply with a notice under this clause within the period specified in the notice.

Maximum penalty: 20 penalty units.

28B Special number-plate concession arrangements

- (1) The Authority may use operational information or release operational information to the special number-plate concessionaire to facilitate the operation of the special number-plate concession concerned or any subsidiary arrangement.
- (2) A person who obtains operational information in the course of exercising functions under a special number-plate concession or a subsidiary arrangement must not make a record of or disclose the information except:
 - (a) in the exercise of the person's functions under or for the purposes of the special number-plate concession, or
 - (b) with other lawful authority.

Maximum penalty: 20 penalty units.

- (3) The Authority may delegate any function of the Authority under this Division (except this power of delegation) to a special number-plate concessionaire.
- (4) In this clause:

operational information means any information obtained by the Authority in the exercise of any function of the Authority, including:

- (a) information in any register kept by the Authority, and
- (b) information that is of a personal nature or that has commercial sensitivity.

special number-plate concession means a commercial arrangement entered into by the Authority for the provision of marketing and other services to the Authority in connection with the issue of special number-plates.

special number-plate concessionaire means a person with whom the Authority enters into a special number-plate concession.

subsidiary arrangement means a commercial arrangement entered into by the special number-plate concessionaire in connection with a special number-plate concession.

28C Possession of number-plates

- (1) A person is guilty of an offence if the person is in possession, without lawful excuse, of number-plates issued by or under the law of New South Wales or any other State or Territory.

Maximum penalty: 30 penalty units.

- (2) A person is guilty of an offence if the person is in possession, without lawful excuse, of number-plates that were not issued by or under the law of New South Wales or any other State or Territory but that could be mistaken for, or resemble, number-plates so issued.

Maximum penalty: 30 penalty units.

Division 6 Renewal of registration

29 Notice for renewal of registration

- (1) A notice of renewal of registration is a notice:
 - (a) addressed to a registered operator of a vehicle, and
 - (b) stating that, if registration of a registrable vehicle is not renewed on or before a specified date, the registration of the vehicle will expire.
- (2) If the Authority fails to send a notice of renewal, that failure does not affect:
 - (a) the expiry of the vehicle's registration, or
 - (b) the obligation of a registered operator to renew the registration of a vehicle that the operator intends to be used on a road or road related area after the expiry of its existing registration.

30 Renewal of registration

- (1) A registered operator may apply for renewal of the registration of a registrable vehicle by submitting to the Authority:
 - (a) an application for renewal of registration in the form approved by the Authority, and
 - (b) the amount of the relevant registration charge applicable to the vehicle and the applicable fee for renewal of registration for the relevant period, and
 - (c) payment or evidence of payment of any applicable third party insurance premium required by third party insurance legislation in respect of the vehicle.
- (1A) However, the Authority may renew the registration of a vehicle if the registered operator is an eligible pensioner (who is not liable to pay any registration charge in relation to the vehicle), without the need for any application.
- (2) An applicant for renewal of registration of a registrable vehicle who is seeking to register the vehicle for a period that differs from the current registration period must nominate a period as if the application for renewal of registration were an application for registration.
- (3) The registration of a registrable vehicle may be renewed:
 - (a) not more than 3 months after the expiry of registration of the vehicle, or
 - (b) in the case of a seasonal vehicle—not more than 12 months after the expiry of registration of the vehicle.
- (4) The expiry date of a renewed period of registration must be calculated as if the renewal had commenced:
 - (a) on the day after the day recorded in the register as the expiry date of the period of the registration being renewed, or
 - (b) in the case of a seasonal vehicle—on the first day of the nominated period.
- (5) Subclauses (3) and (4) do not have the effect of retrospectively registering a registrable vehicle.
- (6) Subject to subclause (7), the Authority must renew the registration of a registrable vehicle.
- (7) The Authority may refuse to renew the registration of a registrable vehicle if the circumstances are such that if an initial application for registration of the vehicle were being made the Authority would refuse the application under clause 12 (1).
- (8) If:

- (a) the period during which the registration of a registrable vehicle may be renewed has expired, and
- (b) the registration of the vehicle has not been renewed, and
- (c) the Authority requests by written notice the registered operator of the vehicle to return the number-plates of the vehicle,

the operator must return the number-plates to the Authority within the period specified in the notice.

Maximum penalty (subclause (8)): 20 penalty units.

Part 3 Alteration of registration status

Division 1 General obligations of registered operators

31 Obligations of registered operators

- (1) Each registered operator of a registered vehicle must ensure that the Authority is notified, in a form approved by the Authority, not more than 14 days after a change in:
 - (a) the vehicle's garage address, or
 - (b) any registered operator's name, home address or address for service of notices.

Note—

Section 4 of the Act defines **home address**, in relation to a body corporate that has a registered office in Australia, to mean the address of its registered office.

- (2) The registered operator of a heavy vehicle that has been:
 - (a) destroyed or declared by the operator to be a write-off, or
 - (b) declared by an insurer to be a write-off,must cause notification of those matters to be given to the Authority not more than 14 days after their occurrence.
- (3) If any change is made to a registrable vehicle that:
 - (a) affects its description as described on the certificate of registration for the vehicle in accordance with clause 15 (1) (e)-(h), or
 - (b) would incur liability for an additional charge under Schedule 2 to the Act or the *Motor Vehicles Taxation Act 1988*,each registered operator of the vehicle must ensure that the vehicle is not used until after:

- (c) the Authority has been notified of the change, and
 - (d) any additional fee or charge attributable to the change has been paid.
- (4) A registered operator is not required to comply with subclause (3) in respect of a change referred to in subclause (3) (a) if the operator has already provided that information under clause 11 of Schedule 2 to the Act.
- (5) A registered operator of a registrable vehicle must present the vehicle for inspection or testing in accordance with reasonable notice in writing served on the operator by the Authority.
- (6) A registered operator of a registrable vehicle must provide any information reasonably required by the Authority to demonstrate that the garage address recorded in the Register is the vehicle's actual garage address.

Maximum penalty: 20 penalty units.

Division 2 Transfer of registration

32 Obligations of disposers: provision of inspection reports

- (1) This clause applies only to an examinable vehicle that is not:
- (a) a public passenger vehicle, or
 - (b) a vehicle in respect of which a person is exempted by the Authority from submitting an inspection report with an application for registration or renewal of registration.
- (2) A person who offers an examinable vehicle for sale to another person must, before or when the other person is shown the vehicle:
- (a) give an inspection report for the vehicle to the other person, being a report issued within the last 42 days, or
 - (b) make the report available to the other person, so that the report may be read by the other person.

Maximum penalty: 20 penalty units.

- (3) A person who sells an examinable vehicle (whether as an agent or the principal) must give the purchaser, for retention by the purchaser, before or when the purchaser takes possession of the vehicle, the inspection report referred to in subclause (2).

Maximum penalty: 20 penalty units.

- (4) The following persons are exempted from this clause:
- (a) any person, in respect of an offer to sell, or the sale of, an examinable vehicle:

- (i) that has been, within the 42 days immediately preceding the offer or the sale, registered for the first time, or
- (ii) the registration of which has been renewed within those 42 days in accordance with this Regulation,
- (b) any person, in respect of an offer to sell, or the sale of, an examinable vehicle:
 - (i) to a dealer, or
 - (ii) at an auction conducted in accordance with section 23B or 23C of the *Motor Dealers Act 1974*, or
 - (iii) to an auto-dismantler, or a motor vehicle parts reconstructor, licensed under the *Motor Dealers Act 1974* for the purpose of demolishing or dismantling the vehicle,
- (c) a dealer, in respect of an offer to sell, or the sale, by the dealer, in the capacity of a dealer, of an examinable vehicle,
- (d) an auto-dismantler, in respect of an offer to sell, or the sale, by the auto-dismantler, in the capacity of an auto-dismantler, of an examinable vehicle that is substantially demolished or dismantled.

(5) In this clause:

examinable vehicle means any one of the following registrable vehicles:

- (a) cars,
- (b) station wagons,
- (c) motor bikes,
- (d) trailers having an unladen weight of less than 1.02 tonnes,
- (e) motor lorries having a GVM of 4.5 tonnes or less,
- (f) any other motor vehicles having a GVM of 4.5 tonnes or less and to which number-plates are attached.

33 Obligations of disposers: application for transfer of registration and notification to Authority

- (1) A person, or the agent of a person, who disposes of a registered registrable vehicle must, immediately after disposing of the vehicle:
 - (a) complete an application for transfer of registration as disposer in the form approved for that purpose by the Authority and sign it, and

- (b) give the completed form to the acquirer.
- (2) If the person or agent is a dealer, the person or agent must also, immediately after disposing of the vehicle, notify the Authority of the following:
 - (a) the full names and addresses of the following persons:
 - (i) if the dealer is an agent for another person—the person on whose behalf the vehicle has been disposed of,
 - (ii) the person who has acquired the vehicle,
 - (b) the date of the disposal,
 - (c) the number of any number-plate issued under this Regulation for use on the vehicle.
- (3) This clause does not apply to a passing of possession of a registrable vehicle:
 - (a) under any hiring (not being a hiring under a hire-purchase agreement) or under any lending (not being a lending under a lease agreement) of a registrable vehicle, or
 - (b) to an agent for the purposes of sale or disposal, or to a bailee for the purpose of alteration, repair, renovation, garaging, storing or any other similar purpose not involving the use of the vehicle for the benefit of the bailee, or
 - (c) in accordance with an order of a court in Australia or other legal process.

34 Obligations of acquirers

- (1) Except as provided by subclause (2), a person who acquires, or the agent of a person who acquires, a registered registrable vehicle must, as soon as practicable after acquiring the vehicle:
 - (a) complete as the acquirer the form obtained from the disposer as referred to in clause 33 to the extent indicated on the form and sign it, and
 - (b) not more than 14 days after acquiring the vehicle, lodge the completed and signed application with the Authority accompanied by any duty payable under applicable duty legislation and the applicable fee for transfer of registration of the vehicle.

Maximum penalty: 20 penalty units.

- (2) If a registered vehicle is acquired in accordance with an order of a court in Australia or other legal process, the person, or the agent of the person, who acquires the vehicle must:
 - (a) obtain evidence of the court order or other legal process and complete the

registration transfer form as the acquirer to the extent indicated on the form and sign it, and

- (b) not more than 14 days after acquiring the vehicle, lodge the completed and signed application with the Authority accompanied by any duty payable under applicable duty legislation and the applicable fee (if any) for transfer of registration of the vehicle.

Maximum penalty: 20 penalty units.

- (3) If the applicable fee referred to in subclause (1) includes an additional amount payable by reason of the making of the application after a date or period, the Authority may in a particular case exempt an applicant from liability to pay that additional amount if the Authority is satisfied there is sufficient cause for doing so.
- (4) A person who acquires, or the agent of a person who acquires, a registered registrable vehicle is not required to pay the applicable fee referred to in subclause (1) if the person is a veteran to whom section 24 of the *Veterans' Entitlements Act 1986* of the Commonwealth applies.
- (5) This clause does not apply to a passing of possession of a registrable vehicle:
 - (a) under any hiring (not being a hiring under a hire-purchase agreement) or under any lending (not being a lending under a lease agreement) of a registrable vehicle, or
 - (b) to an agent for the purposes of sale or disposal, or to a bailee for the purpose of alteration, repair, renovation, garaging, storing or any other similar purpose not involving the use of the vehicle for the benefit of the bailee.

35 Repossession and restoration

- (1) The holder of a security interest in a registered registrable vehicle must notify the Authority, and apply for transfer of the vehicle, not more than 14 days after:
 - (a) taking possession of the vehicle from a registered operator, or
 - (b) returning possession of the vehicle to a registered operator.
- (2) Notification of taking or returning possession must be in a form approved by the Authority.
- (3) An application for transfer after taking or returning possession of a registered registrable vehicle:
 - (a) must be in a form approved by the Authority for the purpose, and
 - (b) must be accompanied by the applicable fee for transfer of registration of the vehicle.

36 Registration of the transfer of vehicles and functions of the Authority

- (1) The Authority may refuse to register the transfer of registration of a registrable vehicle if:
 - (a) the registrable vehicle is the subject of a vehicle defect notice that:
 - (i) prohibits use of the vehicle or imposes conditions on the use of the vehicle, and
 - (ii) has not been cleared in accordance with this Regulation, or
 - (b) the vehicle is registered on condition that it not be transferred, or
 - (c) the requirements of this Regulation relating to transfer of registration have not been complied with, or
 - (d) the Authority reasonably believes that the ownership, possession, control or description of the registrable vehicle (or of any part of the registrable vehicle) is uncertain, or
 - (e) the person disposing of, or the person acquiring the registrable vehicle, fails to comply with the requirements of a law in force in this State relating to certificates of roadworthiness for, or inspection of, registrable vehicles, or
 - (f) the Authority would refuse an application to register the vehicle under this Regulation, or
 - (g) the Authority has sought further information or supporting evidence in relation to the transfer and the information or evidence has not been furnished to the Authority, or
 - (h) the Authority is for any reason of the opinion that the person to whom the registration is proposed to be transferred is not a fit and proper person to be a registered operator of the vehicle, or
 - (i) if the vehicle has more than one registered operator—the Authority is not satisfied that each registered operator consents to the transfer, or
 - (j) the Authority is satisfied that the effective management of the vehicle has not changed.
- (2) The Authority may refuse to register the transfer of registration of a registrable vehicle for which any special number-plate has been issued unless:
 - (a) the distinguishing number of the registration has been altered in accordance with this Regulation, and
 - (b) any number-plate issued for the vehicle has been surrendered to the Authority.

- (3) The Authority must refuse to register a transfer of registration of a registrable vehicle if an order of a court in Australia prohibits the transfer of registration of the vehicle, and the Authority has been notified of the order.
- (4) The Authority may register the transfer of a registrable vehicle, despite the failure of one of the parties to the transfer to meet a requirement of this Regulation relating to the transfer of registrable vehicles, if the Authority considers it appropriate to do so in the circumstances.
- (5) If the Authority is advised by a registered operator of a registrable vehicle that the vehicle has been disposed of, the Authority may make an entry in the Register to that effect pending the receipt of the application for transfer.
- (6) If the Authority registers a transfer of a registrable vehicle it must issue a new certificate of registration, make an endorsement on the certificate of registration or issue a form of transfer of registration to the person acquiring the vehicle.
- (7) The Authority may, subject to any condition that it thinks fit, exempt any person or class of persons from all or any provisions of this Division (other than this subclause).

37 Transfer on death of registered operator

- (1) On notification of the death of a registered operator of a registrable vehicle, the Authority may transfer the registration to any person who applies to the Authority for the transfer if:
 - (a) the person proves to the satisfaction of the Authority that the person is reasonably entitled to the transfer, and
 - (b) in the case of a vehicle that has more than one registered operator—the Authority is satisfied that each remaining registered operator consents to the transfer, and
 - (c) the certificate of registration for the vehicle is surrendered to the Authority, and
 - (d) any applicable fee in respect of the transfer is paid.
- (2) A transfer may be cancelled by the Authority if, during the currency of the registration, any person produces probate of the will or letters of administration granted to the person for the estate of the deceased and applies, pursuant to the will or letters of administration, to have the registration transferred to a person other than the person to whom the registrable vehicle has been transferred under subclause (1).
- (3) Any person to whom a certificate of registration has been transferred under subclause (1) must, in the event of the transfer being cancelled, immediately deliver the certificate of registration to the Authority on being requested to do so.

Maximum penalty (subclause (3)): 20 penalty units.

38 Partial transfer of light vehicle

- (1) If a light vehicle is currently registered in the name of a person, the Authority may record an additional person as a registered operator of the vehicle, but only if it first approves an application by the additional person for the partial transfer of the registration of the vehicle.
- (2) For the purposes of this clause, the Authority may approve an application for the transfer of registration only if:
 - (a) the application is signed by each existing registered operator as indicated on the application form, and
 - (b) the application is accompanied by any duty payable under applicable duty legislation and the applicable fee for transfer of registration of the vehicle, and
 - (c) the person provides such information and supporting evidence as the Authority may require, and
 - (d) the Authority is satisfied that, had the vehicle been sold to the person and clauses 32–34 been complied with, it would not have refused to transfer the registration of the vehicle to the person under clause 36.
- (3) If the Authority records an additional person as a registered operator of a registrable vehicle after approving the person's application for the transfer of registration, the Authority must issue a new certificate of registration bearing the names of both the existing registered operator and the additional registered operator.

Division 3 Expiry of registration

39 Expiry of registration

- (1) The registration of a registrable vehicle expires at the end of the day recorded in the Register as the vehicle's registration expiry date.
- (2) A renewal of a registration takes effect:
 - (a) from the expiry of the registration, or
 - (b) if reissued by the Authority to take effect from an earlier day—from that day.
- (3) If the registration of a registrable vehicle expires, the registered operator must, if requested to do so by a written notice from the Authority, return the vehicle's number-plates to the Authority (or an agent nominated by the Authority) within the period specified in the notice.
- (4) A registered operator to whom a written notice is given under this clause must comply with any requirement specified in the notice.

Maximum penalty (subclause (4)): 20 penalty units.

Division 4 Surrender and cancellation of registration

40 Surrender of registration by registered operator

- (1) A registered operator, personally or by an agent who produces written evidence of his or her appointment as agent, may apply to the Authority to surrender the registration of a registrable vehicle.
- (2) The Authority must approve an application for the surrender of the registration of a registrable vehicle unless:
 - (a) a registered operator of the vehicle has failed to meet the requirements of this Regulation, or
 - (b) the Authority is taking action to suspend or cancel the registration, or
 - (c) if the vehicle has more than one registered operator—the Authority is not satisfied that each registered operator consents to the surrender.

Note—

Part 6 provides for the refund of fees in the case of a surrender or cancellation of registration.

41 Suspension or cancellation of registration by Authority

- (1) The Authority may suspend or cancel the registration of a registrable vehicle in accordance with this Division if:
 - (a) a vehicle defect notice relating to the vehicle has not been complied with and the date for compliance specified in the notice has expired, or
 - (b) the vehicle does not comply with the applicable vehicle standards for the vehicle, or
 - (c) any amounts payable in relation to the vehicle under duty legislation, the Act or this Regulation have not been paid, or
 - (c1) the vehicle ceases to be an insured motor vehicle within the meaning of the *Motor Accidents Compensation Act 1999*, or

Note—

Section 14 of the *Motor Accidents Compensation Act 1999* requires the RTA to comply with a request by a licenced insurer to suspend or cancel the registration of a motor vehicle in certain circumstances.

- (d) a payment in a form other than cash submitted to the Authority as payment of a relevant registration charge or fees or duty is dishonoured, or
- (e) a penalty imposed on a registered operator of the vehicle in respect of the

operation of the vehicle is unpaid and no court order for the payment of a penalty by instalments has been made, or

- (f) a registered operator of the vehicle has not complied with a court order for the payment by instalments of a penalty imposed on the registered operator in respect of the operation of the vehicle, or
- (g) the vehicle has been destroyed or damaged beyond repair, or
- (h) the Authority reasonably believes that the ownership, possession, control or description of the registrable vehicle (or of any part of the registrable vehicle) as recorded on the Register is uncertain, or
- (i) the Authority has approved an application to surrender registration of the vehicle, or
- (j) any tax on the vehicle under the provisions of any Act is due and unpaid, or
- (k) the Authority is satisfied that the registration has been issued erroneously, or
- (l) the Authority is, for any reason whatsoever, of the opinion that a registered operator of the vehicle is not a fit and proper person to be the holder of the registration for the vehicle, or
- (m) (Repealed)
- (n) a registered operator of the vehicle has failed to comply with a requirement imposed by or under this Regulation to return or surrender a number-plate for the vehicle.

(2) The Authority may suspend the registration of a registrable vehicle for a period not exceeding 3 months if the Authority is satisfied, on the balance of probabilities, that a registered operator of the vehicle has failed to use or manage the vehicle so as to effectively prevent repeated violations of the traffic law (whether by the operator or by another person authorised to use the vehicle).

(2A) The Authority may suspend the registration of a registrable vehicle if it appears to the Authority that a registered operator of the vehicle (being a corporation) has committed a second or subsequent offence under section 188 (1) of the Act or a former corresponding provision in relation to any vehicle of the registered operator in any 3 year period.

(2B) The Authority may suspend the registration of a heavy vehicle for a period not exceeding 3 months if 3 or more M5 East Tunnel vehicle emission offences involving the vehicle are committed.

(2C) An **M5 East Tunnel vehicle emission offence** is an offence under clause 16 (1) of the [Protection of the Environment Operations \(Clean Air\) Regulation 2010](#) in relation

to the emission of excessive air impurities by a heavy vehicle being used in the M5 East Tunnel.

(2D) An M5 East Tunnel vehicle emission offence is committed if:

- (a) a court convicts a person of the offence (whether or not it imposes any penalty),
or
- (b) an amount is paid under a penalty notice in respect of the offence, or
- (c) a penalty notice enforcement order under the *Fines Act 1996* is made against a person in respect of the offence.

(3) Clause 42 does not apply to a decision to suspend registration under subclause (2), (2A) or (2B). However, before suspending the registration of a vehicle under any of those subclauses, the Authority:

- (a) must give a registered operator of the vehicle notice in writing of the matters referred to in clause 42 (1) (a) and (b) and the period of suspension, and
- (b) may follow such other procedures prescribed by clause 42 or such other procedures as it considers appropriate.

(4) In this clause, **traffic law** means:

- (a) a provision of Chapter 4 of the Act or this Regulation, or
- (b) any other provision of the road transport legislation.

41A Suspension of registration for dimension requirement offence

(1) The Authority may suspend the registration of a heavy vehicle for a period not exceeding 3 months if:

- (a) a dimension requirement offence involving the vehicle has been committed and one of the following applies:
 - (i) a court has convicted a person of the offence (whether or not it has imposed any penalty),
 - (ii) an amount has been paid under a penalty notice for the offence,
 - (iii) a penalty notice enforcement order under the *Fines Act 1996* has been made against a person for the offence, or
- (b) the Authority is satisfied that a dimension requirement offence involving the vehicle has been committed and the vehicle:
 - (i) caused damage to road infrastructure, or

- (ii) was involved in an accident, or
- (iii) caused a danger or obstruction to traffic, or
- (iv) caused an adverse effect on public amenity.

Note—

A decision of the Authority to suspend the registration of a heavy vehicle under this subclause is an appealable decision in respect of which a person affected has a right of appeal to the Local Court. See sections 266 and 267 of the [Road Transport Act 2013](#).

(2) A **dimension requirement offence** is:

- (a) an offence against rule 102, 103 or 104 of the [Road Rules 2014](#), or
- (b) an offence against section 96 or 102 of the [Heavy Vehicle National Law \(NSW\)](#).

(3) (Repealed)

(4) Clause 42 does not apply to a decision to suspend registration under subclause (1). However, before suspending the registration of a heavy vehicle under that subclause, the Authority:

- (a) must give a registered operator of the vehicle notice in writing of the matters referred to in clause 42 (1) (a) and (b) and the period of suspension, and
- (b) may follow such other procedures prescribed by clause 42 or such other procedures as it considers appropriate.

42 Procedures for suspension and cancellation of registration

(1) If the Authority decides to suspend the registration of a registrable vehicle, the Authority must give a registered operator notice in writing of:

- (a) the reasons for the suspension, and
- (b) the date on which the registration is to be suspended, and
- (c) the action to be taken by the registered operator in order to avoid the suspension or to have the suspension removed.

(2) The Authority must not cancel the registration of a registrable vehicle unless the Authority:

- (a) has suspended the registration and believes that a reason for the suspension still exists, and
- (b) has served notice on each registered operator that:
 - (i) advises the registered operator that the Authority has decided to cancel the

registration of the vehicle and gives the reasons for the decision, and

- (ii) specifies requirements that must be met if the cancellation is to be avoided, and
- (iii) states that, if those requirements are not met within 14 days after the date specified in the notice for that purpose, the cancellation will then take effect, and
- (iv) if there is a right under Part 7.8 of the Act to appeal against the decision—advises the registered operator of the right of appeal.

(3) Subclause (2) does not apply:

- (a) in the case of a cancellation following a surrender of registration by a registered operator under this Division, or
- (b) if the Authority is directed to cancel the registration by the Commissioner of Fines Administration under the *Fines Act 1996*, or
- (c) if the Authority is required to cancel the registration by virtue of section 84 of the Act.

(4) If the requirements stated in the notice referred to in subclause (2) are not met within the period specified in the notice, the registration of the vehicle is cancelled at the end of that period.

(5) If the registration of a vehicle is cancelled, a registered operator must:

- (a) destroy any registration label for the vehicle as soon as practicable after the registration is cancelled, and
- (b) return the certificate of registration and any number-plates issued in respect of the registration to the Authority (or an agent nominated by the Authority) within 14 days after the registration is cancelled.

Maximum penalty: 20 penalty units.

(6) (Repealed)

(7) On cancelling the registration of a registrable vehicle, the Authority may require a registered operator of the vehicle to pay the applicable fee for the cancellation.

42A Cancellation or suspension of registration by court under Heavy Vehicle National Law

(1) The registration of a heavy vehicle under this Regulation is cancelled or suspended in accordance with an order made by a court under section 598 (2) of the Heavy Vehicle National Law in relation to the heavy vehicle.

- (2) The Authority is to take all appropriate steps to give effect to the order.

Part 4 Authorised and permitted uses of unregistered registrable vehicles

Division 1 Unregistered vehicle permits

43 Issue of unregistered vehicle permits

- (1) In this clause, **number** includes a letter of the alphabet.
- (2) The Authority may issue an unregistered vehicle permit for a registrable vehicle that complies with any applicable third party insurance legislation if:
- (a) it would be unreasonable or impracticable to require that the vehicle be registered during a particular period, or
 - (b) the vehicle has been driven, under clause 17 of Schedule 1, to a place for the purpose of obtaining registration and registration has been refused.
- (3) An unregistered vehicle permit authorises, subject to any condition specified in the permit, use of a registrable vehicle on:
- (a) a road or road related area, or
 - (b) particular roads or road related areas.
- (4) Unless sooner revoked, an unregistered vehicle permit expires on the expiry date recorded in the permit:
- (a) if the permit specifies an expiry time—at that time on the expiry date, or
 - (b) if no expiry time is specified—at the end of the day recorded as the expiry date.
- (5) If the Authority issues an unregistered vehicle permit the Authority must:
- (a) record details of the permit, including any condition to which the permit is subject, in the Register, and
 - (b) assign a temporary identification number to the vehicle.
- (6) Except if otherwise approved by the Authority, an applicant for an unregistered vehicle permit must pay to the Authority any applicable fee for issue of the permit before it is issued.
- (7) The holder of an unregistered vehicle permit must:
- (a) display a notice affixed securely to the registrable vehicle in a prominent position depicting the temporary identification number assigned to the vehicle by the Authority, or

(b) display such information as may be required or authorised by the Authority.

(8) An unregistered vehicle permit may be revoked or varied at any time by the Authority.

Division 2 Trader's plates

44 Issue of trader's plates

- (1) On the payment of the applicable fee, the Authority may issue one or more trader's plates to any person that the Authority is satisfied:
 - (a) is a manufacturer, or repairer of, or dealer in, unregistered registrable vehicles, or
 - (b) provides some other service in relation to unregistered registrable vehicles that is incidental to the manufacture or repair of, or dealings in, those vehicles, being a service that the Authority is satisfied requires the use of trader's plates.
- (2) Despite subclause (1), the Authority is not to issue a trader's plate to a person unless the Authority is satisfied that the person carries on business from premises that the Authority considers to be suitable for the issue of trader's plates.
- (3) A trader's plate issued under this clause:
 - (a) must conform to such specifications as the Authority may determine, and
 - (b) must display:
 - (i) the matter "NSW" and such words (if any) as the Authority may determine with the approval of the Minister, or
 - (ii) the words "New South Wales" and such other words (if any) as the Authority may determine with the approval of the Minister, and
 - (c) remains the property of the Authority.

45 Use of vehicles with trader's plates on road or road related area

For the purposes of section 68 (2) (b) of the Act, a registrable vehicle to which a trader's plate is attached may be used on a road or road related area only if the use of the vehicle is an authorised use under this Division.

46 Purposes for which trader's plates may be used

- (1) Subject to subclause (2), the use of a registrable vehicle to which a trader's plate is affixed on a road or road related area is an authorised use if the vehicle (or in the case of a trailer, the vehicle by which it is drawn):
 - (a) is conveying the trader to whom the plate has been issued or the trader's authorised employee or agent, and is being driven:

- (i) for a purpose connected with its manufacture or repair or connected with a dealing in the vehicle, or
 - (ii) for a purpose connected with a service provided in relation to unregistered registrable vehicles that is incidental to the manufacture or repair of, or dealings in, those vehicles, being a service that the Authority is satisfied requires the use of trader's plates, or
 - (iii) to the nearest convenient motor registry for registration by the most direct or convenient route, or
 - (iv) for delivery at the address of a person who has acquired it from such a trader, or
- (b) is being test driven by a prospective purchaser who is in possession of a written authorisation to drive the vehicle issued by the trader to whom the plate has been issued or by the trader's authorised employee or agent.
- (2) Nothing in subclause (1) authorises the use on a road or road related area of a registrable vehicle to which a trader's plate is affixed for the carriage of a load unless:
- (a) the load is carried solely for the purpose of demonstrating to a genuine prospective purchaser the capacity of the vehicle for carrying a particular type of weight of loading, or
 - (b) the vehicle is being driven by the most direct or convenient route to the premises of the trader to whom the plate has been issued from the place at which the trader has manufactured or purchased the vehicle and the loading consists solely of a registrable vehicle manufactured or purchased by such a trader for sale by the trader, or
 - (c) the vehicle is a trailer specially constructed for the carriage of a boat and the loading consists solely of a boat, or
 - (d) the vehicle weighs not more than 2 tonnes unladen and is being driven:
 - (i) by the shortest practicable route to the premises of the trader from the place at which the trader has manufactured or purchased the vehicle and the loading consists solely of goods that are intended for the trader's personal use or for use in his or her business as a trader, or
 - (ii) solely for carrying spare parts (being spare parts for use in connection with the repair of registrable vehicles by such a trader) to the trader's premises from a railway station or airport to which they have been consigned to the trader.
- (3) A person must not authorise an individual to test drive on a road or road related area an unregistered registrable vehicle to which a trader's plate is attached unless:

- (a) the person is the trader to whom the trader's plate has been issued or is the trader's authorised employee or agent, and
- (b) the person reasonably believes the individual to be a genuine prospective purchaser, and
- (c) the person has made a record of the individual's name and address, and
- (d) the person has provided the individual with a written authorisation to drive the vehicle.

Maximum penalty: 20 penalty units.

- (4) In this clause:

trader's authorised employee or agent means an employee or agent of the trader duly authorised in writing.

47 Trader to keep and produce record

A person to whom a trader's plate for a registrable vehicle is issued must:

- (a) in respect of each occasion on which a registrable vehicle is driven on a road or road related area with the plate affixed—cause particulars to be entered in ink on a record in a form approved by the Authority, and
- (b) keep any such record at the premises in which the person carries on the business in respect of which the trader's plate was issued for at least 6 months after the record was made, and
- (c) produce any such record for the preceding 6 months for inspection when required so to do by:
 - (i) the Authority, or
 - (ii) any police officer.

Maximum penalty: 20 penalty units.

48 Questions regarding use of plate to be answered

Any driver or person in charge of a registrable vehicle to which a trader's plate is affixed or any person to whom a trader's plate has been issued must, when required to do so by any police officer, immediately answer truthfully all questions that are put to the person concerning the purpose for which the plate is used.

Maximum penalty: 20 penalty units.

49 Disposal or cessation of business

If a trader to whom a trader's plate has been issued sells, disposes of or ceases to carry on the business to which the trader's plate relates, the trader must immediately give written notification to the Authority of the sale, disposal or cessation of the business and deliver the trader's plate to the Authority.

Maximum penalty: 20 penalty units.

50 Return of trader's plate

- (1) If the Authority is satisfied that a person has ceased for any reason to be entitled to hold a trader's plate issued to the person, the Authority may request the person immediately to deliver the trader's plate to the Authority.
- (2) Subject to subclause (1), any person to whom a trader's plate has been issued must, not later than 14 days after the expiration of the period for which the trader's plate was issued, deliver the trader's plate to the Authority.

Maximum penalty: 20 penalty units.

- (3) A person must not drive, or allow to be driven, or be in charge of, any registrable vehicle on a road or road related area if there is affixed to or displayed upon the vehicle any trader's plate that was issued for a period that has expired.

Maximum penalty: 20 penalty units.

Division 3 Persons unaware of registration status

50A Vehicles being driven in the course of motor industry business

- (1) For the purposes of section 68 (2) (b) of the Act, the use of an unregistered registrable vehicle on a road or on a road related area is permitted if the person using the vehicle:
 - (a) was not the responsible person for the vehicle at the relevant time, and
 - (b) was a motor industry business employee or owner using the vehicle in the course of motor vehicle dealing or the repair, inspection, maintenance, cosmetic enhancement or testing of the vehicle at the relevant time.
- (2) Subclause (1) does not apply if it is established that the person using the vehicle knew, or ought reasonably to have known, that the vehicle was unregistered at the relevant time.

50B Vehicles being driven by persons unaware of registration status

For the purposes of section 68 (2) (b) of the Act, the use of an unregistered registrable vehicle on a road or on a road related area is permitted if the person using the vehicle:

- (a) was not the responsible person for the vehicle at the relevant time, and

- (b) can establish that he or she did not know, and could not reasonably have known, that the vehicle was unregistered at the relevant time.

Part 5 Vehicle standards

Division 1 General requirements

51 Applicable vehicle standards

For the purposes of this Regulation, the **applicable vehicle standards** for a registrable vehicle are:

- (a) in the case of a light vehicle—the requirements specified in Schedule 2 to this Regulation that apply to the vehicle, and
- (b) in the case of a heavy vehicle within the meaning of the *Heavy Vehicle National Law (NSW)*:
 - (i) the heavy vehicle standards (within the meaning of that Law) that apply to the vehicle, and
 - (ii) the requirements of clause 61 (Number-plates) of Schedule 2 to this Regulation that apply to the vehicle.

Note—

Schedule 2 applies only to light vehicles, except for clause 61 of that Schedule (which applies to all registrable vehicles, including heavy vehicles).

52 Registrable vehicles to comply with vehicle standards specified in Schedule 2

- (1) A person must not use a registrable vehicle on a road or road related area unless:
 - (a) in the case of a light vehicle:
 - (i) the vehicle complies with the applicable vehicle standards for the vehicle, and
 - (ii) the vehicle and its parts and equipment are suitable for safe use and are in a thoroughly serviceable condition, or
 - (b) in the case of a heavy vehicle within the meaning of the *Heavy Vehicle National Law (NSW)*—the vehicle complies with the requirements of clause 61 (Number-plates) of Schedule 2 to this Regulation that apply to the vehicle.

Maximum penalty: 20 penalty units.

Note—

Section 60 of the *Heavy Vehicle National Law (NSW)* makes it an offence for a person to use, or permit to be used, on a road a heavy vehicle that contravenes a heavy vehicle standard applying to the vehicle under that Law.

- (2) Without limiting the liability of any other person under subclause (1), a registered operator (other than a registered operator using a vehicle in contravention of that subclause) of a registrable vehicle that is used in contravention of subclause (1) is also guilty of an offence under that subclause.
- (3) A person is not guilty of an offence under subclause (1) if:
 - (a) the vehicle concerned is used on a road or road related area in accordance with a condition imposed on its use, given expressly or by necessary implication, by a police officer or the Authority under section 76 of the Act, or
 - (b) the vehicle:
 - (i) fails to comply with the dimension limits prescribed by Division 2 of Part 4 of Schedule 2, and
 - (ii) is exempted from the dimension limits by the operation of a provision of Division 3 of Part 7, or
 - (c) the vehicle is conditionally registered under this Regulation despite a failure to comply with an applicable vehicle standard for the vehicle and is used on a road or road related area in accordance with the conditions of registration, or
 - (d) the vehicle concerned is used on a road or road related area in accordance with the conditions of an unregistered vehicle permit.
- (4) If any person employed by a registered operator of a registrable vehicle that is a light vehicle to drive the vehicle becomes aware that the vehicle is not in a safe and thoroughly serviceable condition to be used on a road or road related area, the person must:
 - (a) prepare, as soon as is practicable, in duplicate, a report on a form supplied to the person for that purpose by the registered operator that includes the prescribed particulars, and
 - (b) retain a copy of the report and, as soon as is practicable:
 - (i) leave the other copy of the report with the registered operator, or
 - (ii) if it is not practicable for the registered operator personally to take delivery of the report—leave the report for the operator with a person, or at a place, appointed by the operator for the purpose.

Maximum penalty: 20 penalty units.

- (5) A registered operator of any registrable vehicle that is a light vehicle who employs any person to drive the vehicle must:
 - (a) provide the driver with forms for the purposes of subclause (4) and appoint a

person with whom, or a place at which, any report referred to in that subclause may be left for the operator when it is not practicable for the registered operator to take delivery of it, and

- (b) retain a copy of any report left with or for the registered operator under subclause (4) for a period of 6 months from the date of the report, and
- (c) produce the report (or cause it to be produced) for inspection if requested to do so by a police officer or the Authority.

Maximum penalty: 20 penalty units.

(6) Nothing in subclause (4) or (5) affects the liability of any person under subclause (1) or (2).

(7) In this clause:

prescribed particulars, in relation to a report referred to in subclause (4), means:

- (a) the date of the report, and
- (b) the registration number of the vehicle, and
- (c) a statement specifying which parts or equipment of the vehicle need, in the person's opinion, to be repaired, replaced or adjusted to put the vehicle in a safe and thoroughly serviceable condition.

registrable vehicle includes a road train and any component vehicle of a road train and a B-double.

Division 2 Standards and certifications

53 Compliance with vehicle standards

- (1) The Authority may accept as evidence that a registrable vehicle complies with the applicable vehicle standards for the vehicle:
 - (a) an identification plate relating to the vehicle, or
 - (b) a certificate to that effect issued by the manufacturer of the vehicle, or
 - (c) the fact that the vehicle and the registered operator of the vehicle are the subject of a national maintenance accreditation, or
 - (d) the fact that the vehicle and the registered operator of the vehicle are the subject of accreditation under a non-national maintenance accreditation scheme approved by the Authority.
- (2) In the absence of evidence mentioned in subclause (1), the Authority may, on inspecting the registrable vehicle, issue a certificate to the effect that the vehicle

complies with the applicable vehicle standards for the vehicle.

54 Non-complying and non-standard vehicles

A registrable vehicle that does not comply with the applicable vehicle standards may be conditionally registered if the vehicle has:

- (a) an operations plate installed on it in accordance with this Division, or
- (b) a certificate of approved operations issued in accordance with this Division, or
- (c) an identification plate relating to the vehicle.

55 Operations plates and certificates of approved operations

- (1) The Authority may authorise a person to install an operations plate on, or issue a certificate of approved operations for, a registrable vehicle that has been manufactured or modified in such a way that the vehicle does not comply with the applicable vehicle standards for the vehicle.
- (2) An operations plate installed on, or a certificate of approved operations issued for, a registrable vehicle must indicate:
 - (a) any deficiencies in the vehicle's operating characteristics, and
 - (b) any conditions that should be applied to the vehicle's registration.
- (3) (Repealed)

55A Modifications to registered light vehicles

- (1) A person must not carry out modifications on a registered light vehicle (whether by the addition or removal of components or otherwise) that results in the vehicle failing to comply with the applicable vehicle standards.

Maximum penalty: 20 penalty units.

- (2) A light vehicle, or a modification to a light vehicle, that complies with the Authority standard compliance specifications or those provisions of *Vehicle Standards Bulletin 14* that relate to the way in which the relevant modification is to be undertaken is taken to comply with the applicable vehicle standards for the registered light vehicle.
- (3) However, if there is any inconsistency between the applicable vehicle standards and those specifications or provisions, or if those specifications or provisions are silent on a matter dealt with by the applicable vehicle standards, the light vehicle or modification must comply with the applicable vehicle standards.

Note—

Section 85 of the [Heavy Vehicle National Law \(NSW\)](#) makes it an offence for a person to modify (or to use or

permit the use on a road of) a heavy vehicle unless the modification has been approved by:

- (a) an approved vehicle examiner under section 86 of that Law, or
- (b) the National Heavy Vehicle Regulator under section 87 of that Law.

55B Construction of or modification to registered vehicles

The Authority may publish guidance material on how a person may demonstrate that a vehicle complies with the applicable vehicle standards.

Division 3 Inspections

Subdivision 1 When vehicles may be inspected

56 Directed inspections

- (1) The Authority or a police officer may require a person to present a registrable vehicle for inspection by the Authority or an authorised examiner at a time and place specified in a notice in writing served on the person if:
 - (a) the person has control over the vehicle, or
 - (b) the vehicle is registered and the person is a registered operator of the vehicle.
- (2) A person on whom a notice under subclause (1) has been served may, not later than 24 hours before the time specified in the notice, request the Authority or police officer to change the time or place of inspection.
- (3) The Authority or police officer must consider any request made under subclause (2) and must, if it is reasonable to do so, notify the person of any change in the time or place of inspection.
- (4) A person must comply with:
 - (a) any notice served on the person under subclause (1), or
 - (b) any notification given to the person under subclause (3).

Maximum penalty: 20 penalty units.

- (5) The Authority may require the registered operator of a registrable vehicle that is inspected pursuant to this clause to pay the applicable fee for the inspection.
- (6) Subclause (5) does not apply to any of the following vehicles if the inspection is carried out solely for the purpose of determining whether the vehicle's exhaust emission levels comply with this Regulation:
 - (a) a motor lorry with a GVM of 4.5 tonnes or more,
 - (b) an articulated motor lorry,

- (c) a prime mover,
- (d) a tow truck,
- (e) a trailer,
- (f) a bus or other vehicle equipped to seat more than 8 adult persons,
- (g) a taxi-cab.

57 Periodic inspections

- (1) Unless otherwise determined by the Authority, a registrable vehicle must be inspected by the Authority or by an authorised examiner:
 - (a) except as provided by paragraph (b), at least once every year, or
 - (b) in the case of a public passenger vehicle, at least twice every year.
- (2) In the case of a vehicle to be inspected by the Authority:
 - (a) the fees to accompany an application for the registration or renewal of registration of the vehicle must include:
 - (i) except as provided by subparagraph (ii), the applicable fee for one inspection of the vehicle, or
 - (ii) in the case of a public passenger vehicle, the applicable fees for 2 inspections of the vehicle, and
 - (b) the date, time and place for an inspection of the vehicle is to be as agreed between the Authority and the registered operator of the vehicle, and
 - (c) unless otherwise determined by the Authority, if the vehicle is not presented for an inspection in accordance with such an agreement:
 - (i) the inspection fee for that inspection is forfeited to the Authority, and
 - (ii) if the vehicle is subsequently presented for inspection, a further inspection fee must be paid to the Authority before the vehicle is inspected.
- (3) An agreement referred to in subclause (2) (b) may be varied at the request of the registered operator of the vehicle so long as the request is made not later than 24 hours before the time currently agreed.

Subdivision 2 Authorised examiners and inspection stations

58 Examiner's authorities

- (1) The Authority may authorise in writing any person who, in its opinion, is suitably

qualified and of suitable character:

- (a) to conduct inspections and tests of registrable vehicles at authorised inspection stations for the purposes of determining whether or not the vehicles:
 - (i) are suitable for safe use, or
 - (ii) comply with the requirements of the Act and this Regulation, or
 - (iii) without limitation, comply with the requirements of the *Heavy Vehicle National Law (NSW)* and the regulations in force for the purposes of that Law, and
 - (b) to issue inspection reports relating to those inspections.
- (2) However, the Authority must not issue an examiner's authority to any person unless the person has undertaken, and has passed, a course of instruction for examiners that is approved by the Authority and conducted by an organisation approved by the Authority.
- (2A) Without limiting subclause (1), an examiner's authority may be issued to authorise the holder of the authority to conduct inspections and tests referred to in subclause (1) at any place (other than on a road), but only in relation to such classes of heavy vehicles as are specified in the authority.
- (3) An examiner's authority may be subjected at any time to such conditions as the Authority may consider appropriate in relation to the person or class of persons concerned.
- (4) An examiner's authority:
- (a) applies to the inspection of registrable vehicles generally or to the class or classes of registrable vehicles specified in the authority, and
 - (b) remains in force until it is surrendered, suspended or cancelled, and
 - (c) is to be issued in the manner and in the form approved by the Authority, and
 - (d) is subject to any condition imposed under this Subdivision.
- (5) An examiner's authority, or a duplicate of such an authority, must not be issued unless:
- (a) the applicant for the authority or duplicate has paid to the Authority the applicable fee for the issue of the authority, or
 - (b) the Authority has exempted the applicant from payment of that fee.
- (6) The charge that may be made for the issue of an inspection report referred to in

subclause (1) must not be more than the maximum charge for the time being specified by the Authority.

(7) A person must not:

(a) conduct an inspection or test of a registrable vehicle for the purpose of determining whether or not the vehicle is suitable for safe use or complies with the Act or this Regulation unless the person is the holder of an examiner's authority, or

(b) issue an inspection report relating to such an inspection unless the person is the holder of an examiner's authority.

Maximum penalty: 20 penalty units.

(8) The holder of an examiner's authority must not breach a condition of the authority.

Maximum penalty: 20 penalty units.

(9) A person must not issue an inspection report if the person knows, or ought reasonably to suspect, that the report is false or misleading in a material particular.

Maximum penalty: 20 penalty units.

(10) The Authority may exempt any person or class of persons from the requirement under subclause (2) to have undertaken, or to have passed, a course of instruction for examiners.

59 Proprietor's authorities

(1) A person may be authorised in writing to use premises for the purpose of conducting inspections and tests of registrable vehicles by authorised examiners if the Authority is satisfied that:

(a) the premises and the equipment on the premises are suitable for that use, and

(b) the person is competent to carry out the responsibilities associated with using the premises for that purpose, and

(c) the person, and each person specified in the application for the proprietor's authority as being a person who will be involved in the use of the premises for that purpose, are of suitable character.

(2) However, the Authority must not issue a proprietor's authority to any person unless the person has undertaken, and has passed, a course of instruction for proprietors that is approved by the Authority and conducted by an organisation approved by the Authority.

(3) A proprietor's authority may be subjected at any time to such conditions as the

Authority may consider appropriate in relation to the person or class of persons concerned.

- (4) A person must not use premises for the purposes of conducting an inspection or test referred to in subclause (1) unless the person is the holder of a proprietor's authority in force in respect of the premises.

Maximum penalty: 20 penalty units.

- (4A) A person is not guilty of an offence under subclause (4) if the premises being used for the purposes of conducting an inspection or test are used in accordance with an authority issued under clause 58 (2A).

- (5) A person who uses premises for the purposes of conducting an inspection or test referred to in subclause (1) must not permit an inspection report to be issued from those premises in relation to any such inspection or test if the person knows, or ought reasonably to suspect, that the report is false or misleading in a material particular.

Maximum penalty: 20 penalty units.

- (6) For the purposes of this Regulation, a licence in force under the *Motor Vehicle Repairs Act 1980* is taken to be a proprietor's authority issued in accordance with this clause.

- (7) A proprietor's authority:

(a) applies to the inspection of registrable vehicles generally or to the class or classes of registrable vehicles specified in the authority, and

(b) except in the case of a proprietor's authority that is a licence under the *Motor Vehicle Repairs Act 1980*:

(i) remains in force until it is surrendered, suspended or cancelled by the Authority, and

(ii) is to be granted, issued or refused (as the case requires) by the Authority, and if granted or issued, to be in the manner and form approved by the Authority, and

(c) is subject to any condition imposed under this Subdivision.

- (8) A proprietor's authority (other than a proprietor's authority that is a licence under the *Motor Vehicle Repairs Act 1980*), or a duplicate of such an authority, must not be issued unless:

(a) the applicant for the authority or duplicate has paid to the Authority the applicable fee for the issue of the authority, or

(b) the Authority has exempted the applicant from payment of that fee.

- (9) The Authority may exempt any person or class of persons from the requirement under subclause (2) to have undertaken, or to have passed, a course of instruction for proprietors.

60 Authority may issue rules for the purposes of this Subdivision

- (1) The Authority may issue rules, not inconsistent with the Act or this Regulation, relating to all or any of the following:
- (a) the inspection and testing of registrable vehicles to determine whether they are suitable for safe use or comply with the Act or this Regulation,
 - (b) the issue of inspection reports,
 - (c) the use of authorised inspection stations or other places for the purposes of conducting inspections or tests of registrable vehicles,
 - (d) the furnishing of information as to persons involved in:
 - (i) the conduct of inspections and tests of registrable vehicles at authorised inspection stations or other places, or
 - (ii) the use of authorised inspection stations or other places for the purposes of conducting such inspections and tests.
- (2) The Authority may, from time to time, alter any rules so issued.
- (3) It is a condition of an examiner's authority or proprietor's authority that the holder of the authority comply with any rule in force under this clause that is issued to the person.
- (4) If:
- (a) a person, not being an authorised examiner or an authorised proprietor, requests a copy of any such rules, or
 - (b) an authorised examiner, or an authorised proprietor, to whom a copy of those rules has been issued requests a further copy,
- the Authority must issue such a copy or further copy on payment of the applicable fee. However, the Authority may issue a copy without fee in a particular case.

61 Books of inspection reports

On payment of the applicable fee, the Authority may issue a book of inspection reports to the holder of a proprietor's authority.

62 Suspension or cancellation of examiner's authorities and proprietor's authorities

- (1) The Authority may suspend or cancel an examiner's authority or a proprietor's

authority (other than a proprietor's authority that is a licence under the *Motor Vehicle Repairs Act 1980*) if:

- (a) the holder has failed to comply with a condition to which the authority is subject, or
- (b) the Authority is, for any reason, of the opinion that the holder is not a fit and proper person to continue to hold the authority.

(2) Without limiting subclause (1) (b):

- (a) the Authority may form the opinion that the holder of an examiner's authority is not a fit and proper person to continue to hold the authority if it is satisfied that any person involved in the conduct of inspections and tests of registrable vehicles pursuant to the authority is not of suitable character, and
- (b) the Authority may form the opinion that the holder of a proprietor's authority is not a fit and proper person to continue to hold the authority if it is satisfied that any person involved in the use of an authorised inspection station pursuant to the authority is not of suitable character.

(3) The Authority cannot suspend or cancel an examiner's authority or a proprietor's authority unless:

- (a) the Authority by notice in writing requests the person concerned to show cause why the authority should not be suspended or cancelled on the grounds specified in the notice, and
- (b) that person replies to the notice or fails to reply within 21 days from the date the notice was issued.

(4) Subclause (3) does not apply to the suspension of an examiner's authority or a proprietor's authority if the Authority has reason to suspect that the holder of the authority wilfully failed to comply with any rule in force under this Subdivision and is likely to commit further breaches of those rules.

63 Committee of review

(1) The Authority is to appoint a committee of review to which the Authority may refer for consideration and report to the Authority any case where consideration is being given to the refusal, suspension or cancellation of an examiner's authority or a proprietor's authority.

(2) The committee of review is to include:

- (a) a representative of the Authority, who is to be the chairperson of the committee, and

- (b) representatives of such organisations associated with trading in or servicing of registrable vehicles as the Authority considers appropriate.
- (3) The committee of review may determine its own procedure for dealing with cases referred to it by the Authority for consideration and report.
- (4) The committee of review must take into consideration any reply to a notice referred to in clause 62 (3) that is received by the Authority before the Authority refers the matter to which the notice relates to the committee.
- (5) The committee of review is to report to the Authority on any matter referred to it for consideration and must state in the report any recommendation that it wishes to make.
- (6) If members of the committee of review do not agree on the nature of a recommendation to be so stated, the committee must record the disagreement in its report and may state in the report more than one recommendation.
- (7) In determining whether to suspend or cancel an examiner's authority or a proprietor's authority under this Subdivision, the Authority is to have regard to the report of the committee of review but is not bound to follow any recommendation contained in the report.

64 Notification of decisions by Authority

- (1) If an application for the issue of an examiner's authority or a proprietor's authority is refused, or if an examiner's authority or proprietor's authority is suspended or cancelled by the Authority, the Authority must notify the applicant or holder of the authority in writing of the refusal, suspension or cancellation and of the grounds for it.
- (2) The decision of the Authority to suspend or cancel an authority has effect:
 - (a) on and from the date that is 21 days after the date on which the holder of the authority is notified, or
 - (b) if the holder appeals to the Local Court under Part 7.8 of the Act against the decision—subject to any orders of the Court and to the provisions of clause 135 of the *Road Transport (General) Regulation 2013*.
- (3) Despite subclause (2), if the Authority has reason to suspect that the holder of an authority has wilfully failed to comply with any rule in force under this Subdivision and is likely to commit further breaches of those rules, the decision of the Authority to suspend or cancel the authority may be expressed, in the instrument by which the holder is notified of the decision, to be effective on and from the date on which the holder is notified, and the decision has effect accordingly.
- (4) The date on which a holder is notified under this clause is:

- (a) if the notice is sent by mail—the date when the notice would be delivered in the ordinary course of post, or
 - (b) if the notice is delivered to the holder personally—the date when it is so delivered.
- (5) If the decision of the Authority to suspend or cancel an authority has effect, the holder must immediately deliver to the Authority any forms issued by the Authority in connection with the authority together with the authority itself.

Division 4 Component identification numbers

65 Definitions

In this Division:

component identification number, when used in relation to a part of a registrable vehicle, means the number and any accompanying letters or symbols stamped on or otherwise affixed to that part as a means of identifying the part (but does not include any casting number or any number used as a means of identifying a class of parts for manufacturing purposes).

vehicle part of a registrable vehicle means:

- (a) the engine of the vehicle, or
- (b) the engine block of the vehicle, or
- (c) in relation to a motor vehicle other than a motor bike—the chassis, chassis sub-frame or body of the vehicle, or
- (d) in relation to a motor bike—the frame or the crankcase of the motor bike.

66 Allotment of component identification numbers

- (1) The Authority may allot an engine number for a vehicle part of a registrable vehicle if:
 - (a) there is no component identification number on the vehicle part of the vehicle or the component identification number of any such part appears to have been altered, defaced, removed or obliterated, and
 - (b) the Authority is satisfied that such a number is necessary for the purpose of identifying the vehicle part.
- (2) The Authority may, by notice in writing, require the registered operator of any such vehicle to have the number it has allotted to the vehicle part concerned stamped on the part in such a position as the Authority may specify in the notice.

67 Altering component identification numbers of vehicle parts without authority

- (1) A person (other than a manufacturer) must not, without the written authority of the

Authority and except in accordance with this Part, stamp or affix (or cause or permit any other person to stamp or affix) any component identification number on or to a vehicle part or a registrable vehicle.

- (2) A person must not alter, deface, remove or obliterate any component identification number stamped on or otherwise affixed to a vehicle part of a registrable vehicle otherwise than in accordance with this Part.
- (3) A person must not possess a vehicle part of a registrable vehicle knowing that the component identification number stamped on or otherwise affixed to the part has been altered, defaced, removed or obliterated otherwise than in accordance with this Part.

Maximum penalty: 20 penalty units.

68 Change or replacement of vehicle part

Any person who changes or replaces a vehicle part of a registrable vehicle must:

- (a) notify the Authority of such change or replacement within 14 days of the change or replacement, and
- (b) specify the following in the notification:
 - (i) the date of the change or replacement,
 - (ii) the registration number, if any, of the vehicle,
 - (iii) the name and address of each registered operator of the vehicle,
 - (iv) the make and component identification number of the vehicle part removed from the vehicle,
 - (v) the make and component identification number of the vehicle part substituted for the original vehicle part,
 - (vi) the name and address of the person from whom the substituted vehicle part was obtained, and
- (c) retain a copy of the notification in the person's possession for a period of 6 months, and
- (d) produce a copy of any such notification for inspection if requested to do so by any police officer or the Authority.

Maximum penalty: 20 penalty units.

69 Interference with component identification number

The registered operator of a vehicle may, if authorised in writing by the Authority, alter,

deface, remove or obliterate any component identification number stamped on or otherwise affixed to a vehicle part of the vehicle.

Division 5 Vehicle defect notices

70 Issue of defect notices and formal warnings

(1) A vehicle defect notice may be stated to be:

- (a) a major vehicle defect notice if, in the reasonable opinion of the person issuing the notice, the further use of the registrable vehicle in road transport after the time specified in the notice would constitute an imminent and serious safety risk, or
- (b) a minor vehicle defect notice if, in the reasonable opinion of the person issuing the notice, deficiencies in the registrable vehicle, if allowed to continue after the time specified in the notice, may:
 - (i) constitute a safety risk, or
 - (ii) hinder the ability of a person to identify the vehicle by reference to its number-plates.

Note—

Section 76 of the Act provides that a police officer or the Authority may issue a vehicle defect notice.

Safety risk is defined in the Dictionary to mean danger to a person, to property or to the environment.

(2) A vehicle defect notice must state:

- (a) the registrable vehicle's registration details including the registration number, unregistered vehicle permit number (if practicable and applicable), expiry date and jurisdiction of registration, and
- (b) the name of the driver of the registrable vehicle or, if the driver is not present when the notice is issued, the term "registered operator", and
- (c) to the extent practicable, the registrable vehicle's identification details including its VIN, or if there is no VIN, the chassis number or engine number, its make and type, and
- (d) the type of inspection conducted, and
- (e) the details of the registrable vehicle's defects and whether the notice is a major vehicle defect notice or a minor vehicle defect notice, and
- (f) the time and date after which the registrable vehicle is not to be used on a road or road related area, and
- (g) the means by which the registrable vehicle must be moved to another location

following issue of the vehicle defect notice, and

- (h) the repair requirement, including the date by which repairs must be completed if the vehicle is to be used on a road or road related area, and
- (i) whether a penalty notice was also served in relation to the defect at that time, and
- (j) the name, official number or other identification of the person who issued the notice.

(3) A person who issues a vehicle defect notice, must:

- (a) in the case of a registrable vehicle the driver of which is present—give the notice to the driver, and
- (b) in the case of a registrable vehicle that is unattended—cause the vehicle defect notice to be affixed to the vehicle, and
- (c) in the case of a major defect notice—cause a defective vehicle label to be affixed to the registrable vehicle.

(4) A driver of a registrable vehicle (other than a registered operator of the vehicle) who is given a vehicle defect notice in accordance with subclause (3) must cause the notice to be sent to a registered operator of the vehicle.

Maximum penalty: 20 penalty units.

(5) A defective vehicle label must state:

- (a) the registrable vehicle's registration number, and
- (b) the time and date after which the registrable vehicle is not to be used on a road or road related area, and
- (c) the means by which the registrable vehicle must be moved to another location following issue of the vehicle defect notice to which the label relates, and
- (d) the name, official number or other identification of the person who issued the notice, and
- (e) the date of issue of the label, and
- (f) the serial number of the defect notice to which the label relates.

(6) If a person who is entitled to issue a vehicle defect notice considers that deficiencies in a registrable vehicle should be remedied even though they do not constitute a safety risk or hinder the ability of a person to identify the vehicle by reference to its number-plates, the person may:

- (a) in the case of a registrable vehicle where the driver is present—give the driver a

formal written warning, and

(b) in the case of a registrable vehicle that is unattended—cause the formal written warning to be affixed to the vehicle.

(7) A driver of a registrable vehicle who is given a formal written warning in accordance with subclause (6) must cause the warning to be sent to a registered operator of the vehicle.

Maximum penalty (subclause (7)): 20 penalty units.

71 Recording, clearance and withdrawal of vehicle defect notices

(1) If a vehicle defect notice is issued under the Act, the Authority must record in the Register in relation to the vehicle:

(a) the serial number of the notice, and

(b) the date (if any) shown on the notice for the clearance of the vehicle unless that date is later than the date of any recorded certificate of inspection.

(2) The Authority may conduct or require to be conducted an inspection for the purposes of considering whether the defects described in a vehicle defect notice have been rectified and that the registrable vehicle does not have any other defects.

(2A) The Authority may require a registered operator of a registrable vehicle that is inspected pursuant to this clause to pay the applicable fee for the inspection.

(3) A vehicle defect notice may be cleared by the Authority or an authorised person.

(4) For the purposes of this Regulation, a vehicle defect notice is cleared when:

(a) the Authority receives evidence, in a form approved by the Authority, that the registrable vehicle is no longer defective, and

(b) in the case of a major defect notice—the Authority causes the defective vehicle label to be defaced or removed from the registrable vehicle.

(5) A person must not deface or remove a defective vehicle label unless authorised to do so by the Authority.

Maximum penalty: 20 penalty units.

(6) On the vehicle defect notice being cleared, the Authority must make a record in the Register to the effect that the notice has been cleared.

(7) A person who issues a vehicle defect notice may withdraw that notice at any time and must cause:

(a) notice of the withdrawal to be sent to the person to whom the notice was issued,

and

- (b) a record to be made in the Register to the effect that the vehicle defect notice has been withdrawn.

Division 6

72-76 (Repealed)

Part 5A Certification of vehicles

Division 1 Preliminary

76AA Definitions

- (1) In this Part:

certifier's licence or **licence** means a certifier's licence in force under this Part.

compliance certificate means a certificate issued in accordance with this Part.

inspect a vehicle includes test a vehicle.

licensed certifier means a person who holds a certifier's licence.

modification of a vehicle includes the addition of components to, or the removal of components from, the vehicle.

- (2) Divisions 2 and 3 apply in relation to light vehicles only.

Note—

See Part 3.3 of the [Heavy Vehicle National Law \(NSW\)](#) with respect to the modification of heavy vehicles within the meaning of that Law.

Division 2 Significantly modified vehicles

76AB Significant modifications to vehicles

- (1) The Authority may declare a modification, or class of modifications, to a vehicle to be modifications to which this Division applies.
- (2) A declaration is to be made by order published in the Gazette and may be made only if the Authority is of the opinion that any such modification may pose a risk of harm to any person or affect the safe operation of a vehicle.

76AC Modified vehicles not to be used unless certified

- (1) A person must not use a vehicle on a road or road related area and the registered operator or owner of the vehicle must not permit the vehicle to be used in such a way if the vehicle has had a modification to which this Division applies.

Maximum penalty: 20 penalty units.

- (2) A person does not commit an offence under subclause (1) if a compliance certificate has been issued in respect of the modification or in respect of the whole vehicle as modified and any such certificate has not been cancelled.

Division 3 Compliance certificates

76AD Compliance certificate may be issued

- (1) A licensed certifier may issue a compliance certificate in a form approved by the Authority to the registered operator of a vehicle (or, if the vehicle is unregistered, to the owner of the vehicle).
- (2) A licensed certifier must not issue a compliance certificate in respect of a vehicle unless the certifier:
 - (a) holds a licence that permits the certifier to issue the particular compliance certificate, and
 - (b) has inspected the vehicle and has decided that:
 - (i) the vehicle complies with the applicable vehicle standards, or
 - (ii) the particular modification to the vehicle to which the certificate relates does not cause the vehicle to fail to comply with the applicable vehicle standards.
- (2A) For the purposes of subclause (2) (b), a light vehicle, or a modification to a light vehicle, that complies with the Authority standard compliance specifications or those provisions of *Vehicle Standards Bulletin 14* that relate to the way in which the relevant modification is to be undertaken is to be taken to comply with the applicable vehicle standards for the vehicle.
- (2B) However, if there is any inconsistency between the applicable vehicle standards and the specifications or provisions referred to, or if those specifications or provisions are silent on a matter dealt with by the applicable vehicle standards, the light vehicle or modification must comply with the applicable vehicle standards for the purposes of subclause (2) (b).
- (3) A licensed certifier must not issue a compliance certificate if the certifier knows, or ought reasonably to suspect, that the certificate is false or misleading in a material particular.
- (4) A licensed certifier must pay to the Authority, within the time specified by the Authority, the applicable fee for each compliance certificate issued under this clause.

Maximum penalty: 20 penalty units.

76AE Authority may cancel compliance certificate

- (1) The Authority may, by notice in writing given to a registered operator of a vehicle (or, if the vehicle is unregistered, to the owner of the vehicle), cancel a compliance certificate that relates to the vehicle if, in the opinion of the Authority:
 - (a) the certificate was issued fraudulently, incorrectly or negligently, or
 - (b) the certificate is no longer relevant owing to subsequent modifications to the vehicle, or
 - (c) the vehicle no longer complies with the applicable vehicle standards.
- (2) The compliance certificate is cancelled at the time the notice is given or, if a later time is specified in the notice, at that later time.

76AF Person may drive vehicle for purpose of compliance certificate

A person does not commit an offence under clause 52 (Registrable vehicles to comply with vehicle standards specified in Schedule 2), 76AC (Modified vehicles not to be used unless certified) or the registration provisions (within the meaning of Schedule 1) in respect of a vehicle that is being driven:

- (a) to a licensed certifier for the purpose of obtaining a compliance certificate by the most direct and convenient route, or
- (b) in the course of the inspection of the vehicle by a licensed certifier, or
- (c) from any such inspection by the most direct and convenient route to the nearest place where work can be carried out on the vehicle to enable it to meet the applicable vehicle standards, but only if the driver of the vehicle has written notice from the licensed certifier who inspected the vehicle that the vehicle does not pose an imminent risk to road safety.

Division 4 Licensing of certifiers

76AG Definition

In this Division:

vary a licence includes imposing or revoking conditions to which the licence is subject or varying such conditions.

76AH Applications with respect to licences

- (1) An individual may apply to the Authority for a certifier's licence or for the renewal or variation of such a licence.
- (2) An application must:

- (a) be made in the manner and form approved by the Authority, and
 - (b) be supported by any information required by the Authority, and
 - (c) be accompanied by the applicable fee for the particular application, and
 - (d) in the case of an application for a renewal or variation of a licence, be made during the term of the existing licence.
- (3) The Authority is to decide an application by approving or refusing the application.
- (4) The Authority may, at its discretion, refuse an application on any ground.
- (5) The Authority must refuse an application for a licence or an application for a renewal of a licence if it is of the opinion that a person is not competent, or is not a fit and proper person, to hold a licence.
- (6) The Authority must give notice in writing to the applicant of its decision including, if the Authority decides to issue or renew a licence, the term of the licence.
- (7) If the Authority refuses an application the notice must specify the reasons for the refusal.

76A1 Licences

- (1) A certifier's licence is to be issued in the manner and form approved by the Authority and may be issued unconditionally or subject to conditions.
- (2) The term of a licence (unless cancelled or surrendered sooner) is the term of 1 year or such other period as may be specified by the Authority.
- (3) The Authority may, by notice in writing to the holder of a licence, cancel or suspend the licence or vary the licence or the term of the licence:
- (a) if the holder has failed to comply with this Part, including any condition to which the licence may be subject under this Part, or
 - (b) if the holder is not, in the opinion of the Authority, competent to hold the licence, or
 - (c) if the holder is not, in the opinion of the Authority, a fit and proper person to hold the licence, or
 - (d) at its discretion on any other ground.
- (4) A variation, suspension or cancellation takes effect at the time the notice is given or, if a later time is specified in the notice, at that later time.
- (5) The holder of a licence must not breach a condition of the licence.

Maximum penalty: 20 penalty units.

- (6) The holder of a licence may surrender the licence at any time by notice in writing to the Authority.

76AJ Consultation before making certain decisions

- (1) This clause applies to the following decisions of the Authority under this Part:
- (a) a decision to suspend or cancel a licence,
 - (b) a decision to refuse an application to renew a licence,
 - (c) a decision to impose or vary a condition on a particular licence (rather than on all licences).
- (2) Before the Authority makes a decision to which this clause applies, the Authority must:
- (a) give the person concerned notice in writing of the grounds for the proposed decision, and
 - (b) request in that notice that the person make a written submission, within 21 days, with respect to the proposed decision, and
 - (c) take into account any submission received from the person within that 21-day period.

76AK Immediate suspensions

- (1) The Authority may suspend a licence immediately (an **immediate suspension**) without complying with clause 76AJ if the Authority is proposing to cancel the licence because it is of the opinion that the holder of the licence:
- (a) has wilfully failed to comply with any requirement of this Part, including any condition to which the licence may be subject under this Part, or
 - (b) poses a risk to road safety if he or she continues to hold the licence.
- (2) After it imposes an immediate suspension, the Authority must, in respect of the proposed cancellation of the licence:
- (a) give notice under clause 76AJ within 14 days, and
 - (b) make its final decision within 35 days after giving that notice (the **specified period**).
- (3) An immediate suspension remains in force with respect to a licence:
- (a) if the Authority decides, within the specified period, to cancel the licence—until

the licence is cancelled or, if the decision to cancel the licence is the subject of an appeal, until the Court overturns the decision or orders that the suspension should no longer remain in force, or

- (b) if the Authority decides, within the specified period, not to cancel the licence—until that decision is made, or
- (c) if the Authority makes no decision within the specified period—until the end of that specified period.

76AL Record keeping requirements

- (1) The holder of a licence must keep a record of the following in respect of each inspection undertaken for the purposes of this Part:
 - (a) the following identification details of the vehicle on which the inspection was carried out:
 - (i) the registration number of the vehicle (if issued),
 - (ii) the vehicle identifier of the vehicle,
 - (iii) the make and model of the vehicle,
 - (iv) the build date or compliance date of the vehicle,
 - (b) a record of the methods and calculations used during the inspection,
 - (c) the results of the inspection,
 - (d) a record of any compliance certificate issued as a result of the inspection.
- (2) A person who is required to keep a record under this clause must keep the record for at least 7 years after it is made.
- (3) A person who is required to keep a record under this clause must produce the record to the Authority or an authorised person when required to do so by the Authority or an authorised person.

Maximum penalty: 20 penalty units.

76AM Insurance

- (1) In this clause:

required insurance, in respect of a person, means professional indemnity insurance and public liability insurance that:

- (a) indemnify the person against any liability to pay compensatory damages arising from any act or omission of the person in the exercise of the functions of a

licensed certifier under this Part, and

(b) satisfy any other requirements of the Authority that are set out in an order of the Authority that is published in the Gazette for the purposes of this clause.

(2) A licensed certifier must not hold out that the licensed certifier is covered by the required insurance unless the licensed certifier is covered by the required insurance.

Maximum penalty: 20 penalty units.

(3) A person must be covered by:

(a) the required insurance at all times that the person is a licensed certifier, and

(b) the required insurance that is professional indemnity insurance for at least 7 years after the person ceases to be a licensed certifier.

Maximum penalty: 20 penalty units.

(4) For the purposes of this section, a person is taken to be covered by the required insurance if the person pays amounts specified by the Authority, at such times as the Authority may direct, towards insurance cover obtained by the Authority on behalf of the person.

(5) A licensed certifier's licence is suspended:

(a) at any time that the licensed certifier is not covered by the required insurance, and

(b) if the licensed certifier is relying on the insurance obtained by the Authority, at any time that there is an amount owing after the date payment is required under subclause (4).

76AN Offence of holding out

(1) A person must not issue a document that purports to certify to the registered operator or owner of a vehicle (for which a compliance certificate is required before the vehicle may be driven on a road or road related area) that the vehicle, or a modification to the vehicle, complies with the applicable vehicle standards unless the document is a compliance certificate.

Maximum penalty: 20 penalty units.

(2) A person must not purport to issue a compliance certificate or hold himself or herself out as a person who may issue such a certificate unless the person is the holder of a licence and the licence permits the person to issue the particular compliance certificate.

Maximum penalty: 20 penalty units.

76AO Service of notices under Part

The date on which a person other than a registered operator is taken to have been given or served with a notice under this Part is:

- (a) if the notice is sent by mail—the fourth working day after the notice was posted, or
- (b) if the notice is delivered to the person personally—the date when it is so delivered.

Note—

Clause 7 of the [Road Transport \(General\) Regulation 2013](#) makes similar provision in respect of notices given or served on registered operators.

76AP Transitional provision—certificates issued under old scheme

- (1) Clause 76AN (1) does not apply to a document issued before 31 January 2012 in respect of a modification to a vehicle if the Authority is satisfied that:
 - (a) the person issuing the document was, immediately before 19 December 2011, authorised to certify such a modification in accordance with a scheme approved by the Authority, and
 - (b) the person commenced his or her inspection of the modified vehicle before 19 December 2011.
- (2) A document referred to in subclause (1) is taken to be a compliance certificate for the purposes of clause 76AC if it is provided to the Authority by the registered operator of the motor vehicle to which the document relates, no later than 19 June 2012 (or such later date as may be permitted by the Authority in any particular case).

Part 6 Charges, fees and refunds

Division 1 Preliminary

76A Definitions

In this Part:

civil defence work means the work of dealing with an emergency as defined in section 4 of the [State Emergency and Rescue Management Act 1989](#).

government-owned vehicle means a vehicle owned by the Crown or by a statutory body representing the Crown.

76B (Repealed)

Division 2 Calculation of registration charges for chargeable heavy vehicles

76C Annual registration charges for chargeable heavy vehicles

- (1) For the purposes of clause 2 of Schedule 2 to the Act, the amount payable as the annual registration charge for a chargeable heavy vehicle is to be calculated in accordance with the provisions of Schedule 4.
- (2) A heavy vehicle must be registered as an individual vehicle or a towing unit in a category under Schedule 4.

76D Calculation of refund of registration charges for heavy vehicles on cancellation of registration

- (1) For the purposes of clause 13 (2) (b) of Schedule 2 to the Act, a refund of a registration charge for a chargeable heavy vehicle is to be calculated in accordance with this clause.
- (2) A refund is to be calculated using the formula:

$$\left(\frac{\text{number of days} \times \text{charge}}{365} \right) - \text{fee}$$

where:

charge means the registration charge paid under Schedule 2 to the Act.

fee means the unpaid fees payable under the Act or this Regulation (including any unpaid fee for the cancellation of the registration).

number of days means the number of unexpired days of the registration period, from the date on which the Authority cancels the registration of the vehicle.

- (3) If an amount of refund determined in accordance with subclause (2) would comprise an amount that is not a whole number of dollars, the amount of refund is to be adjusted downwards to the next whole number of dollars.

76DA Refund of certain registration charges paid during 2012-2013 financial year

- (1) The Authority may refund the whole or part of the registration charges for a chargeable heavy vehicle paid during the 2012-2013 financial year if:
 - (a) the charges were paid before 1 September 2012, and
 - (b) the Authority is satisfied that, as a result of the current use of the vehicle, it would be wholly or partially exempt from registration charges under clause 76JA if its registration were renewed.
- (2) The amount to be refunded under subclause (1) is to be calculated by reference to the same percentages or amounts of the registration charges from which the chargeable heavy vehicle would be exempt under clause 76JA if its registration were renewed.

Division 3 Exemptions from registration charges for chargeable heavy vehicles

76E Exemption for eligible pensioners

- (1) A chargeable heavy vehicle that is owned solely by an eligible pensioner, or jointly owned by 2 or more eligible pensioners only, is exempt from registration charges if:
 - (a) it is not used in the course of any trade, business or profession or let out for hire, and
 - (b) it is used solely or principally by the pensioner or pensioners, and
 - (c) it is used substantially for social or domestic purposes or for pleasure, and
 - (d) it is a vehicle or a vehicle of a class or description of vehicles approved for the time being by the Authority.
- (2) Except as provided by subclause (3), an eligible pensioner is entitled to an exemption from registration charges in respect of one chargeable heavy vehicle only.
- (3) An eligible pensioner is entitled to an exemption from registration charges in respect of 2 chargeable heavy vehicles if the pensioner and another eligible pensioner are the joint registered owners of the vehicles and the pensioners are married to each other or are de facto partners, or reside in the same household.

Note—

“De facto partner” is defined in section 21C of the [Interpretation Act 1987](#).

- (4) (Repealed)

76F Exemption for civil defence vehicles

- (1) A chargeable heavy vehicle (other than a government-owned vehicle) that, while on a road or road related area, is used solely for or in connection with civil defence work and is registered in the name of a body controlling that work is exempt from registration charges.
- (2) The Minister may grant an exemption or partial exemption from registration charges in respect of any other chargeable heavy vehicle (other than a government-owned vehicle) that, while on a road or road related area, is used solely for or in connection with civil defence work.

76G Exemption for vehicles used for mine rescue work

A chargeable heavy vehicle (other than a government-owned vehicle) specially constructed to carry out mine rescue work for the purposes of the [Coal Industry Act 2001](#) is exempt from registration charges.

76H Exemption for vehicles with trader's plates

A chargeable heavy vehicle on which a trader's plate is being used in accordance with the Act is exempt from registration charges.

76I Exemption for vehicles exempted from registration

A chargeable heavy vehicle that is exempted from registration is exempt from registration charges.

76J Exemptions granted by Minister

- (1) The Minister may grant an exemption or partial exemption from registration charges in respect of a chargeable heavy vehicle (other than a government-owned vehicle) for which there is no other provision for exemption or partial exemption under this Division if the vehicle:
 - (a) is, in the Minister's opinion, used solely or principally as an ambulance, and
 - (b) is used by or on behalf of a non-profit organisation having as one of its objects a charitable, benevolent, philanthropic or patriotic purpose.
- (2) The Minister may grant an exemption or partial exemption from registration charges in respect of a chargeable heavy vehicle for which there is no other provision for exemption (other than partial exemption) under this Division if the vehicle is registered conditionally under this Regulation.

76JA Exemptions relating to certain types of converter dolly and small operators

- (1) A chargeable heavy vehicle that is a tri-axle converter dolly is exempt from any registration charges for the vehicle.
- (2) A chargeable heavy vehicle that is a tandem axle converter dolly is exempt from registration charges for the vehicle to the extent of an amount that is equivalent to 50 percent of those registration charges.
- (3) A chargeable heavy vehicle that is a non-converter dolly trailer (the **current trailer**) is exempt from registration charges for the trailer to the extent of the exempt amount for that trailer if, at the time of its registration, the registered operator of the current trailer is also the registered operator of:
 - (a) only one hauling unit, and one (but not more than 4) other non-converter dolly trailers, that are registered at the same time as the current trailer or were previously registered in the current financial year, or
 - (b) only 2 hauling units, and 2 (but not more than 4) other non-converter dolly trailers, that are registered at the same time as the current trailer or were previously registered in the current financial year.

- (4) The **exempt amount** for a current trailer for the purposes of the exemption under subclause (3) is:
- (a) if the registered operator of the current trailer has previously paid lesser registration charges in the current financial year for one or more other non-converter dolly trailers and there was no entitlement to claim the exemption for any of those earlier registered trailers—an amount equivalent to 50 percent of the amount of the lowest registration charges paid for an earlier registered trailer, or
 - (b) in any other case—an amount that is equivalent to 50 percent of the registration charges for the current trailer.
- (5) The exemption provided by subclause (3) only applies in relation to registration charges payable for the registration of a chargeable heavy vehicle for a period of 12 months.
- (6) A term or expression used in this clause that is defined for the purposes of Schedule 4 has the same meaning as in that Schedule.
- (7) In this clause:

non-converter dolly trailer means a trailer other than a converter dolly.

tandem axle converter dolly means a trailer with 2 axles and a fifth wheel coupling designed to convert a semi trailer into a dog trailer.

tri-axle converter dolly means a trailer with 3 axles and a fifth wheel coupling designed to convert a semi trailer into a dog trailer.

Division 4 Miscellaneous

77 Fees

- (1) The following fees are payable under this Regulation:
- (a) fees prescribed by Schedule 3 for the various matters set out in that Schedule,
 - (b) fees fixed by the Authority under subclause (2),
 - (c) fees set by the Authority under clause 20 (Special number-plates).
- (2) The Authority may with the approval of the Minister fix fees to be payable for or in connection with any service provided by the Authority under the Act or this Regulation except any service for which a fee is prescribed by Schedule 3.

Note—

These fees are fixed under section 271 (1) of the Act and are required to be published in the Gazette.

- (3) Subclause (2) does not apply to fees set by the Authority under clause 20.

78 Refunds of fees

- (1) The Authority may make a partial refund of any applicable fee paid in respect of a registrable vehicle if:
 - (a) the Authority approves an application for the surrender of the registration of the vehicle, or
 - (b) the Authority cancels the registration of the vehicle and notification of that cancellation has been received by a registered operator.

- (2) For the purposes of subclause (1), a partial refund is to be calculated using the formula:

$$\frac{\text{number of days}}{\text{period of registration}} \times \text{fee}$$

where:

number of days is the number of unexpired whole days of the registration period of the vehicle, from the date on which the Authority approves an application for surrender made under clause 40 or cancels the registration of the vehicle concerned.

period of registration is the total number of whole days in the period for which the vehicle is registered.

fee is the amount of the applicable fee.

- (3) The Authority may refund (in whole or in part) any applicable fee paid (whether before or after the commencement of this subclause) by an applicant under clause 10 if the Authority is of the opinion that:
 - (a) the applicant was the registered operator of a registrable vehicle that was destroyed or rendered beyond repair as a consequence of damage caused to the vehicle by an occurrence that gave rise to an emergency, and
 - (b) the vehicle to which the application related was a replacement for the damaged vehicle, and
 - (c) in the circumstances of the case it would be appropriate to refund the fee.
- (4) The Authority may deduct from a refund of an applicable fee the amount of any unpaid fees incurred in respect of the vehicle.
- (5) If an amount of refund determined in accordance with subclause (2) would comprise an amount that is not a whole number of dollars, the amount of refund is to be adjusted downwards to the next whole number of dollars.
- (6) In this clause:

emergency has the same meaning as it has in clause 10.

79 (Repealed)

80 Exemption for eligible pensioners

- (1) A registrable vehicle that is owned solely by an eligible pensioner or jointly owned by 2 or more eligible pensioners is exempt from an administrative fee only if:
 - (a) it is not used in the course of any trade, business or profession or let out for hire, and
 - (b) it is used solely or principally by the pensioner or pensioners, and
 - (c) it is used substantially for social or domestic purposes or for pleasure, and
 - (d) it is a vehicle or a vehicle of a class or description of vehicles approved for the time being by the Authority.
- (2) Except as provided by subclause (3), an eligible pensioner is entitled to an exemption from administrative fees in respect of one vehicle only.
- (3) An eligible pensioner is entitled to an exemption from administrative fees in respect of 2 vehicles if the pensioner and another eligible pensioner are the joint registered operators of the vehicles and the pensioners are married to each other or are de facto partners, or reside in the same household.
- (4) In this clause:

administrative fee means an applicable fee for the registration or renewal of registration of an eligible pensioner's registrable vehicle.

81 Refund of number-plate fees

The Authority may, in any case or class of cases that the Authority thinks it appropriate to do so, waive, reduce or refund (in whole or in part) any applicable fee payable or paid for or in connection with the issue, allocation, setting aside, reservation, transfer or replacement of a number-plate.

82, 83 (Repealed)

Part 6A Written-off vehicles

Division 1 Preliminary

83A Definitions

In this Part:

identification details, in relation to a vehicle, means the following:

- (a) whether the vehicle is a motor car, motor lorry, motor bike or trailer,
- (b) the registration number of the vehicle (if issued),
- (c) the vehicle identifier of the vehicle,
- (d) the make and model of the vehicle,
- (e) the shape of the vehicle,
- (f) the colour of the vehicle,
- (g) the variant of the vehicle,
- (h) the build date or compliance date of the vehicle,
- (i) the engine capacity of the vehicle,
- (j) the number of cylinders of the vehicle's engine,
- (k) the motive power of the vehicle,
- (l) the tare weight of the vehicle.

motor bike includes a motor trike.

motor car means a motor vehicle (except a motor bike) that is constructed principally for the conveyance of persons.

personal details of a person means all of the following:

- (a) the name and address of the person,
- (b) the telephone and facsimile numbers (if any) of the person (unless the information is provided to the Authority electronically),
- (c) if the person has a customer number issued to it by the Authority and the information is provided to the Authority in paper form—the customer number of the person,
- (d) if the person is notifying the information on behalf of someone else and does not have a customer number or does not provide the information in paper form—the driver licence number of the person.

registration number of a vehicle includes, in the case of a vehicle the registration of which has expired or been suspended or cancelled, the registration number of the vehicle immediately before its registration expired or was suspended or cancelled.

relevant technical specifications in relation to a vehicle means the standards and methods of repair required to be met by a law of this State for vehicles of that type and:

- (a) the standards and methods of repair documented by the manufacturer of vehicles of that type, to the extent that they are relevant to ensuring the structural integrity and safety of the vehicle, or
- (b) where the manufacturer's documentation is unavailable, the standards and methods of repair recognised in the industry for vehicles of that type.

vehicle damage details, in relation to a vehicle, means the following:

- (a) whether the damage to the vehicle was caused by hail, water, impact, fire or stripping,
- (b) the location and severity of the damage to the vehicle described by reference to the codes or terms that are approved by the Authority from time to time.

83B Meaning of "written-off vehicle"

For the purposes of paragraph (f) of the definition of **written-off vehicle** in section 83 (3) of the Act a notifiable vehicle that has been assessed, in a vehicle damage assessment, as not being a total loss is prescribed if:

- (a) the vehicle has non-repairable damage and the insurer has decided not to repair the vehicle, or
- (b) the insurer has decided not to repair the vehicle and intends to sell, or has sold, the vehicle to a person other than the registered operator of the vehicle at the time the vehicle sustained the damage that resulted in it being presented for the vehicle damage assessment.

Division 2 Non-repairable damage

83C Non-repairable damage—vehicles other than motor bikes or trailers

- (1) For the purposes of the definition of **non-repairable damage** in section 82 of the Act, the following are prescribed in respect of a vehicle (other than a motor bike or trailer):
 - (a) as a result of a fire, the vehicle has sustained a combination of damage to the exterior parts and interior parts of the vehicle,
 - (b) as a result of a fire, the paint on the vehicle has blistered on 3 or more of the primary structural features,
 - (c) the vehicle's occupant cabin has been inundated with water (whether fresh or salt water) to a level exceeding the level of the inner door sill,
 - (d) the vehicle has been stripped of interior or exterior parts, panels or components or of a combination of interior and exterior parts, panels and components,

- (e) the vehicle has damage to both longitudinal structural rails such that they require original equipment manufacture replacement, that is a replacement part that is:
 - (i) manufactured by the manufacturer of the vehicle to which it is being fitted, or
 - (ii) manufactured for the manufacturer of the vehicle to which it is being fitted, or
 - (iii) endorsed for use by the manufacturer of the vehicle to which it is being fitted,
 - (f) the vehicle has excessive structural damage.
- (2) For the purposes of this clause, a vehicle has **excessive structural damage** if 3 or more of the following damage indicators are present in the vehicle:
- (a) any of the primary structural features of the vehicle has been fractured or cut or has buckled or folded over onto itself (where damage to each primary structural feature constitutes a separate damage indicator),
 - (b) due to a collision, damage has been sustained in respect of a suspension mount to the chassis or body of the vehicle, with each of the following constituting a separate damage indicator:
 - (i) if an independent suspension unit is damaged, damage to each station,
 - (ii) if a live axle is damaged, damage to the suspension on that axle,
 - (c) due to a collision, any or all of the following mechanical components is cracked, deformed or broken:
 - (i) the engine block,
 - (ii) the transmission case,
 - (iii) the differential case,
 - (iv) the axle housing,
 - (d) the deployment or activation of any or all of the supplementary restraints (that is, airbags or seatbelt pretensioners).
- (3) For the purposes of calculating the number of damage indicators present in a vehicle:
- (a) each incidence of damage to a pillar or longitudinal structural rail or chassis is to be counted as a separate indicator, and
 - (b) each different and separate area of damage to the floor pan or firewall is to be counted as a separate indicator, and
 - (c) each incidence of structural damage to a suspension station is to be counted as a separate indicator except in the case of live axles, which are to be counted as a

single indicator, and

- (d) damage to any part of the roof is to be counted as a single indicator, and
- (e) damage to any or all of the mechanical components is to be counted as a single indicator, and
- (f) deployment or activation of any or all of the supplementary restraints (that is, airbags or seatbelt pretensioners) is to be counted as a single indicator.

(4) In this clause:

primary structural feature of a vehicle means any of the following:

- (a) the roof,
- (b) a pillar,
- (c) the floor pan,
- (d) a firewall,
- (e) longitudinal structural rails or the chassis.

83CA Non-repairable damage—motor bikes

For the purposes of the definition of **non-repairable damage** in section 82 of the Act, the following are prescribed in respect of a motor bike:

- (a) the motor bike has been burnt to such an extent that it is fit only for wrecking or scrap,
- (b) the motor bike has been stripped of all, or a combination of most, exterior body parts, panels and components (examples of which are the engine, wheels, and guards),
- (c) the motor bike has impact damage (excluding scratching) to the suspension and 2 or more areas of structural frame damage,
- (d) the motor bike has been fully immersed in salt water for any period,
- (e) the motor bike has been fully immersed in fresh water for more than 48 hours.

83CB Non-repairable damage—trailers

(1) For the purposes of the definition of **non-repairable damage** in section 82 of the Act, the following are prescribed in respect of a trailer:

- (a) the trailer has been burnt to such an extent that it is fit only for wrecking or scrap,
- (b) the trailer has been stripped of all, or a combination of most, interior and exterior body parts, panels and components,

- (c) the trailer has impact damage (excluding scratching) to the suspension and 1 or more areas of structural frame damage,
- (d) in relation to a trailer that is not a skeleton-type trailer or box trailer—the trailer has been fully immersed in salt water for any period,
- (e) in relation to a trailer that is not a skeleton-type trailer or box trailer—the trailer has been fully immersed in fresh water for more than 48 hours.

(2) In this clause:

skeleton-type trailer means a frame trailer that does not have a bottom or sides.

Division 3 Authorisations to repair

83D Vehicles that are not eligible for the issue of authorisation to repair

For the purposes of section 85 (1) (b) of the Act, every notifiable vehicle other than the following is prescribed as a non-eligible vehicle:

- (a) a hail-damaged vehicle,
- (b) a vehicle that was inherited by the person seeking an authorisation to repair the vehicle,
- (c) a vehicle in respect of which the applicant for an authorisation to repair the vehicle was a registered operator of the vehicle for more than 28 days before the date on which the vehicle sustained the damage that resulted in it being presented for a vehicle damage assessment.

83E Eligibility to apply for an authorisation to repair

For the purposes of section 85 (1) (c) of the Act, all persons other than the following persons are prescribed as non-eligible persons in relation to a vehicle:

- (a) the registered operator of the vehicle at the time the vehicle sustained the damage that resulted in it being presented for a vehicle damage assessment,
- (b) any person who has inherited the vehicle from the person who was the registered operator of the vehicle at the time the vehicle sustained the damage that resulted in it being presented for a vehicle damage assessment,
- (c) any person who intends to use the vehicle only to participate in motor sport activities approved by the Authority by order published in the Gazette.

83F Term of authorisations to repair

- (1) An authorisation to repair remains in force for 12 months after its issue.
- (2) The Authority may extend the term of an authorisation at any time while it remains in

force.

Division 4 Assessment of vehicles

83G Prescribed qualifications to carry out vehicle damage assessments

- (1) For the purposes of section 90 (1) (a) of the Act, the prescribed training, qualifications and experience are all of the following:
 - (a) the successful completion of an approved course,
 - (b) the demonstrated ability to determine whether or not a vehicle has suffered non-repairable damage,
 - (c) the demonstrated ability to apply each of the following:
 - (i) the relevant technical specifications, and
 - (ii) the written-off vehicle repair guidelines published in the Gazette by the Authority.

- (2) In this clause:

approved course means:

- (a) a training course in vehicle repair assessment provided by a training provider accredited by the Australian Skills Quality Authority, or
- (b) a course that includes instruction on all of the following:
 - (i) the sourcing and interpretation of the standards and methods of repair documented by the manufacturers of vehicles or recognised in the industry for vehicles,
 - (ii) the use of those standards and methods in the calculation of repair costs,
 - (iii) the conduct of assessments of repairs in compliance with those standards and methods,
 - (iv) the assessment of vehicle damage having regard to the types of non-repairable damage that are prescribed by clause 83C.

83H Standards of repairs and repair methods

For the purposes of section 91 (b) of the Act, the standards of repairs, and the repair methods, prescribed in relation to a vehicle are the relevant technical specifications for the vehicle.

83I Records about vehicle damage assessments

- (1) For the purposes of section 94 (1) (a) of the Act, the records that an assessor must

keep in relation to each vehicle damage assessment made by or on behalf of the assessor are the following:

- (a) the identification details of the vehicle,
 - (b) details of the determination as to whether or not the vehicle has suffered non-repairable damage, including the date on which the determination was made,
 - (c) the name of the person who carried out the assessment,
 - (d) the reasons why the person who carried out the assessment was competent to do so,
 - (e) the sum for which the vehicle was insured,
 - (f) the market value of the vehicle and the basis for determining that value,
 - (g) the assessed cost of repairs and details of how the cost of repairs was determined, applying the relevant technical specifications,
 - (h) if the vehicle is not repaired by the assessor—the assessed salvage value of the vehicle and the basis for determining that value.
- (2) The Authority may, by notice in writing, exempt an assessor from any requirement to keep records that are specified in the notice.

Division 5 Notifications about written-off vehicles

83J Notification of information about vehicles assessed as a total loss

The following information is prescribed as the information that must be provided under section 93 (1) of the Act to the Authority in respect of each notifiable vehicle that is assessed as being a total loss in the course of a vehicle damage assessment conducted by or on behalf of an assessor:

- (a) the identification details of the vehicle,
- (b) the vehicle damage details relevant to the vehicle,
- (c) the date on which the vehicle was determined to be a total loss by the assessor,
- (d) the personal details of the assessor and, if the information is notified by an agent of the insurer on behalf of the insurer, the personal details of the notifier,
- (e) the date on which the information is provided.

83K Notification of information about vehicles not assessed as a total loss

- (1) This clause applies to a notifiable vehicle that has been assessed, in a vehicle damage assessment, as not being a total loss if:

- (a) the vehicle has non-repairable damage and the insurer has decided not to repair the vehicle, or
 - (b) the insurer has decided not to repair the vehicle and intends to sell, or has sold, the vehicle to a person other than the registered operator of the vehicle at the time the vehicle sustained the damage that resulted in it being presented for a vehicle damage assessment.
- (2) An insurer must ensure that the Authority is provided with the following information concerning each notifiable vehicle to which this clause applies within 7 days after the decision is made not to repair the vehicle and before it is sold or disposed of:
- (a) the identification details of the vehicle,
 - (b) the vehicle damage details relevant to the vehicle,
 - (c) the date on which the vehicle was determined not to be a total loss by the assessor,
 - (d) the personal details of the assessor and, if the information is notified by an agent of the insurer on behalf of the insurer, the personal details of the notifier,
 - (e) the date on which the information is provided.

Maximum penalty: 20 penalty units.

83L Prescribed information about vehicles disposed of to auto-dismantler

The following information is prescribed as the information that must be provided under section 93 (2) of the Act to the Authority in respect of each notifiable vehicle that is disposed of to an auto-dismantler by a self-insurer:

- (a) the identification details of the vehicle,
- (b) the vehicle damage details relevant to the vehicle,
- (c) the date on which the vehicle was disposed of to the auto-dismantler,
- (d) the personal details of the self-insurer and, if the information is provided to the Authority by another person, the personal details of that person,
- (e) the date on which the information is provided.

83M Prescribed information about demolished or dismantled vehicles

The following information is prescribed as the information that must be provided under section 93 (3) of the Act to the Authority in respect of each notifiable vehicle that an auto-dismantler intends to demolish or dismantle:

- (a) the identification details of the vehicle,

- (b) the vehicle damage details relevant to the vehicle,
- (c) the date on which the auto-dismantler commenced, or intends to commence, work in the course of the auto-dismantler's business for the purpose of demolishing or dismantling the vehicle,
- (d) the personal details of the auto-dismantler and, if the information is provided to the Authority by another person, the personal details of that person,
- (e) the date on which the information is provided.

Division 6 Records about other vehicles

83N Records required to be kept by insurers of information about certain vehicles assessed as not being total losses

- (1) An assessor who is an insurer is required to keep a register containing the following information in relation to each prescribed returned vehicle insured:
 - (a) the identification details of the vehicle,
 - (b) the vehicle damage details relevant to the vehicle,
 - (c) the date on which the vehicle was determined not to be a total loss by the assessor,
 - (d) the personal details of the person who carried out the assessment.

Maximum penalty: 20 penalty units.

- (2) That register must be kept by the assessor for at least 7 years from the time of each entry.

Maximum penalty: 20 penalty units.

- (3) In this clause:

prescribed returned vehicle means a notifiable vehicle:

- (a) that was the subject of a vehicle damage assessment, and
- (b) that was assessed by its insurer as not being a total loss, and
- (c) that the insurer has elected not to repair, and
- (d) that is intended to be returned, or has been returned, by the insurer to the person who was its registered operator at the time the vehicle sustained the damage that resulted in it being presented for a vehicle damage assessment.

Division 7 Written-off vehicle warning labels

83O Obligation to attach written-off vehicle warning labels

An assessor must ensure that a written-off warning label that complies with this Division is attached at all times to any vehicle in the assessor's possession or control that is prescribed as a written-off vehicle by clause 83B:

- (a) to the part of the vehicle to which the vehicle identifier is attached (in the case of a dismantled vehicle), or
- (b) to the vehicle (in any other case).

Maximum penalty: 20 penalty units.

Note—

Section 97 of the Act requires a written-off vehicle warning label to be attached to certain vehicles that have been assessed to be a total loss. Not all written-off vehicles have been assessed as a total loss. This clause creates the same obligation in relation to written-off vehicles not assessed as a total loss.

83P Content and form of written-off vehicle warning label

For the purposes of section 97 (1) of the Act, a written-off vehicle warning label on a vehicle must include the following:

Statutory written-off vehicle—available for parts or scrap only—limited exemptions apply.

83Q Positioning of written-off vehicle warning label

For the purposes of section 97 (1) of the Act, a written-off vehicle warning label must be attached securely and in a conspicuous position where any person looking at the vehicle might be expected to see it, but not in a position that obscures the vehicle identifier.

83R Offence to alter, damage, destroy, remove or interfere with written-off vehicle warning label

A person must not, without reasonable excuse, alter, damage, destroy, remove or otherwise interfere with a written-off vehicle warning label that has been attached to a vehicle under section 97 (1) of the Act or clause 83O.

Maximum penalty: 20 penalty units.

Division 8 Certificates of compliance

83S Standards of repairs and repair methods

For the purposes of section 98 (1) (b) of the Act, the standards of repairs, and the repair methods, prescribed in relation to a vehicle are the relevant technical specifications for the vehicle.

83T Certificates of compliance in relation to electronic control systems

A licensed repairer is not authorised to issue a certificate of compliance in relation to electronic control systems (such as airbags or Anti-lock Braking Systems) unless the licensed repairer is approved by:

- (a) the manufacturer of the vehicle, or
- (b) the Authority.

83U Issue of certificates of compliance

For the purposes of section 98 (1) (b) of the Act, a licensed repairer must not issue a certificate of compliance unless the repairs have been conducted in accordance with:

- (a) the relevant technical specifications, and
- (b) any written-off vehicle repair inspection guidelines published in the Gazette by the Authority that are in force.

Maximum penalty: 20 penalty units.

83V Term of certificates of compliance

A certificate of compliance remains in force for 3 months after its issue, or for any other period approved by the Authority in a particular case.

83W Records of certificates of compliance

A licensed repairer who issues a certificate of compliance, or who examines a vehicle for the purpose of determining whether or not to issue a certificate of compliance, must keep a record of the following in relation to each vehicle certified or examined:

- (a) the identification details of the vehicle,
- (b) the reference number of the authorisation to repair the vehicle issued by the Authority,
- (c) details of the assessment conducted by the licensed repairer for the purpose of determining whether or not to issue a certificate of compliance in relation to the vehicle,
- (d) details of the application in the assessment process of the relevant technical specifications and the written-off vehicle repair guidelines published in the Gazette by the Authority,
- (e) if the repair involved structural damage—the test report attesting to the structural integrity of the repaired vehicle,
- (f) the basis on which the licensed repairer formed an opinion that the vehicle should be

issued with a certificate of compliance,

(g) the date the certificate was issued.

Maximum penalty: 20 penalty units.

Division 9 Special provisions for certain vehicles

83X Superficially-damaged motor bikes

(1) This clause applies to a motor bike:

(a) that is a notifiable vehicle, and

(b) that was insured by an insurer at the time that it sustained the damage that resulted in it being presented for a vehicle damage assessment, and

(c) that sustained superficial damage only, and no structural damage or non-repairable damage, in the event that resulted in it being presented for a vehicle damage assessment, and

(d) that was assessed as being a total loss before 31 December 2015, and notified to the Authority in accordance with section 16L of the former *Road Transport (Vehicle Registration) Act 1997* or section 93 of the *Road Transport Act 2013*, and

(e) in respect of which, the insurer has provided the Authority with documentary and photographic records of the damage that resulted in the motor bike being presented for a vehicle damage assessment and a written statement by the insurer attesting to the fact that the motor bike is structurally safe.

(2) A motor bike to which this clause applies is:

(a) excluded from the vehicles prescribed as non-eligible vehicles by clause 83D, and

(b) is exempt from the obligation to be the subject of a certificate of compliance.

(3) A person who has purchased a motor bike to which this clause applies from an insurer is, in relation to that motor bike, excluded from the persons prescribed as non-eligible persons by clause 83E.

83Y Vehicles returned to registered operator by insurer

(1) In addition to the information required by clause 83J, a certificate of compliance in relation to a vehicle is prescribed as the information that must be provided to the Authority in relation to a prescribed returned vehicle by an assessor who is an insurer under section 93 (1).

(2) For the purposes of section 93 (1) (b) of the Act, the information that is required to be provided to the Authority by section 93, clause 83J and subclause (1) in relation to a

prescribed returned vehicle must be provided within 15 days after the end of the quarter of the financial year in which the vehicle was the subject of a vehicle damage assessment.

- (3) A prescribed returned vehicle is taken not to be a written-off vehicle if the information required by subclause (1) has been provided to the Authority in relation to the vehicle within the period that (1) requires the information to be provided.
- (4) The obligation to provide information to the Authority created by subclause (2) does not have effect until 31 July 2011. The obligation to record the information commences when this clause commences.
- (5) In this clause:

prescribed returned vehicle means a notifiable vehicle:

- (a) that was the subject of a vehicle damage assessment, and
- (b) that was assessed as being a total loss, and
- (c) that has been repaired in accordance with the relevant technical specifications, and
- (d) that is intended to be returned, or has been returned, by the insurer to the person who was its registered operator at the time the vehicle sustained the damage that resulted in it being presented for a vehicle damage assessment.

83YA Hail-damaged vehicles

- (1) A **relevant written-off hail-damaged vehicle** means a notifiable vehicle:
 - (a) that is assessed by an assessor as being a total loss solely due to hail damage, and
 - (b) that is retained by the person who was a registered operator of the vehicle for more than 28 days before the date on which the vehicle sustained the hail damage that resulted in it being presented for a vehicle damage assessment.
- (2) A relevant written-off hail-damaged vehicle is taken to be a former written-off vehicle for the purposes of Part 4.5 of the Act and is to be recorded in the NSW written-off vehicles register as such.
- (3) For the purposes of section 93 (1) (b) of the Act, the prescribed time within which an assessor must ensure that the Authority is provided with the information required to be provided under that paragraph in relation to a relevant written-off hail-damaged vehicle is the last day of the month in which the vehicle damage assessment was completed.

Division 10 Transitional provisions

83Z Existing repairable interstate written-off vehicles may be registered without authorisation to repair

- (1) A vehicle is not required to be the subject of an authorisation to repair under section 84 (2) of the Act if the vehicle is recorded on a register of written-off vehicles (however described) of another Australian jurisdiction as a repairable written-off vehicle on 31 January 2011 and the application to register the vehicle is lodged with the Authority within 2 years after that day.
- (2) (Repealed)

83ZA Application to written-off vehicles on register before commencement date

On and from 31 January 2011, the vehicles that are recorded on the register of written-off vehicles under Part 2AA of the former *Road Transport (Vehicle Registration) Act 1997* as former written-off vehicles and that have been registered may be known as inspected written-off vehicles.

83ZB Vehicles eligible for authorisation to repair before substitution of clause 83D

- (1) Clause 83D, as in force immediately before its substitution by the *Road Transport (Vehicle Registration) Amendment (Written-off Vehicles) Regulation 2012*, continues to apply to an application for an authorisation to repair that was made but not determined before that substitution.
- (2) A vehicle does not become a non-eligible vehicle for the purposes of Part 2AA of the former *Road Transport (Vehicle Registration) Act 1997* because of the substitution of clause 83D by the *Road Transport (Vehicle Registration) Amendment (Written-off Vehicles) Regulation 2012* if:
 - (a) an authorisation to repair was issued in respect of the vehicle before that substitution, or
 - (b) an authorisation to repair is issued in respect of the vehicle in relation to an application to which subclause (1) applies.

83ZC Relevant written-off hail-damaged vehicles taken to be former written-off vehicles

Any vehicle that would have been a relevant written-off hail-damaged vehicle (within the meaning of clause 83YA) had that clause been in force when the vehicle was assessed as a total loss is taken at the time of that assessment to have been a former written-off vehicle and the NSW written-off vehicles register is to be updated accordingly.

83ZD Transitional provision: non-repairable damage

The amendment made by the *Road Transport (Vehicle Registration) Amendment (Non-repairable Damage) Regulation 2012* concerning the prescription of matter for the purposes of the definition of **non-repairable damage** in section 82 of the Act does not

apply to a vehicle damage assessment completed before 3 September 2012.

Part 7 Miscellaneous

Division 1 Offences

84 Use of vehicle offences

- (1) A person must not use, or permit the use of, a registrable vehicle that is conditionally registered in breach of a condition of registration.

Maximum penalty: 20 penalty units.

- (2) A person must not use, or permit the use of, a registrable vehicle in contravention of a defect notice.

Maximum penalty: 20 penalty units.

- (3) A person must not cause or permit another person to use an unregistered registrable vehicle (other than a vehicle that has had its registration suspended) on a road or road related area except as provided by Part 4.

Maximum penalty: 20 penalty units.

- (4) Subclause (3) does not apply in relation to the use of an unregistered registrable vehicle if the person causing or permitting the use of the vehicle does so in contravention of section 74 (1) of the Act.

- (5) A person must not cause or permit another person to use a registrable vehicle that has had its registration suspended on a road or road related area unless that use has been authorised by the Authority.

Maximum penalty: 20 penalty units.

- (6) For the purposes of section 68 (2) (b) of the Act, the use of a registrable vehicle on a road or road related area during any period in which its registration has been suspended by the Authority is permitted if that use has been authorised by the Authority.

- (7) For the purposes of section 81 (b) of the Act, subclauses (3) and (5) are prescribed.

Note—

Section 81 of the Act provides for the seizure of number-plates.

85 Number-plate and registration certificate and label offences

- (1) The driver of a registrable vehicle is guilty of an offence if the vehicle is used on a road or in a road related area:

- (a) with a number-plate affixed that was not issued by the Authority or was not issued

for that vehicle, or

- (b) with any registration label (that is required to be affixed to the vehicle) obscured, defaced, or otherwise not legible, or not displayed or affixed in accordance with this Regulation, or
- (c) with a registration label that has expired (unless the vehicle is no longer required to have a registration label affixed).

Maximum penalty: 20 penalty units.

- (1A) The driver of a registrable vehicle registered by the Authority is guilty of an offence if the vehicle is used on a road or road related area without displaying number-plates issued by the Authority for the purpose of authorising the use of the vehicle.

Maximum penalty: 20 penalty units.

- (2) The driver of a registrable vehicle is guilty of an offence if the vehicle is used on a road or in a road related area displaying:
- (a) an altered number-plate or registration label, or
 - (b) the representation of a number-plate or registration label:
 - (i) other than a number-plate or registration label issued in accordance with this Regulation or another law, and
 - (ii) that is likely to be mistaken for a number-plate or registration label displayed in accordance with this Regulation.

Maximum penalty: 20 penalty units.

- (3) The registered operator of a registrable vehicle (other than the driver of the vehicle) used in contravention of subclause (1), (1A) or (2) is also guilty of an offence if it is proved that the operator caused, permitted, allowed or failed to take reasonable precautions to prevent the contravention.

Maximum penalty: 20 penalty units.

- (4) This clause does not apply to:
- (a) the use of trader's plates, or
 - (b) the use of a registered vehicle for the purpose of number-plate testing authorised by the Authority if the vehicle displays a sign indicating that number-plate testing is being carried out.

86 Notification offences

- (1) A person must provide notification to the Authority as required by this Regulation.

Maximum penalty: 20 penalty units.

- (2) Subclause (1) does not apply to a notification requirement under a provision of this Regulation for the contravention of which a maximum penalty is prescribed by the provision.
- (3) A person must not provide false or misleading information to the Authority about the location of the garage address of a registrable vehicle.

Maximum penalty: 20 penalty units.

Division 2 Disposal of forfeited vehicles

87 How forfeited vehicles may be disposed of under section 79 of the Act

- (1) For the purposes of section 79 (6) of the Act, a forfeited vehicle may be disposed of by public auction or public tender.
- (2) For the purposes of section 79 (6) of the Act, the vehicle may be disposed of otherwise than by sale if the Authority is satisfied on reasonable grounds that the vehicle has no monetary value or that the proceeds of sale would be unlikely to exceed the costs of sale.
- (3) If a forfeited vehicle offered for sale is not sold, the Authority may dispose of the forfeited vehicle otherwise than by sale.

88 Proceeds of sales of vehicles seized under section 79 of the Act

- (1) For the purposes of section 79 (7) of the Act, if a forfeited vehicle is sold in accordance with this Division, the Authority holds the net proceeds of sale (if any) of the vehicle for the person who was the owner of the vehicle immediately before its sale.
- (2) An application for payment of the net proceeds of sale may be made to the Authority at any time within 12 months after the forfeited vehicle was sold.
- (3) The Authority must pay the net proceeds of sale to the applicant if satisfied that the applicant is entitled to the proceeds.
- (4) If no application is made within that 12 month period, the Authority may transfer the net proceeds of sale to such of its funds as it considers appropriate. The money then becomes the property of the Authority.
- (5) In this clause:

net proceeds of sale means the proceeds (if any) of a sale of a forfeited vehicle remaining after deduction of:

- (a) the expenses of sale, and

- (b) the fees, charges, taxes and fine, that the Authority could have allowed under section 79 (5) of the Act for the waiver of the forfeiture.

Division 3 Other provisions

88A (Repealed)

89 More than one person recorded as registered operator of light vehicle

- (1) Subject to this Regulation, if more than one person is recorded as a registered operator of a light vehicle:
- (a) any right, liability or obligation conferred or imposed on a registered operator of the registrable vehicle by the relevant legislation is taken to be conferred or imposed on each person recorded, and
 - (b) each person recorded is taken to have complied with any obligation imposed by the relevant legislation if any one of the persons recorded has (whether personally or through an agent) complied with the obligation, and
 - (c) the Authority is taken to have complied with any obligation to give notice to the registered operator of the vehicle that is imposed by the relevant legislation if it notifies any one or more of the persons recorded.
- (2) In this clause, **relevant legislation** has the same meaning as it has in section 64 of the Act.

90 Application of [Road Transport \(Mass, Loading and Access\) Regulation 2005](#)

- (1) A vehicle is exempted from a dimension limit or any other requirement of this Regulation if the person or vehicle is exempted from that limit or requirement by or under a provision of the [Road Transport \(Mass, Loading and Access\) Regulation 2005](#) or a provision of a regulation that replaces that regulation.
- (2) A breach of this Regulation is to be disregarded in any prosecution if it is to be disregarded under the [Road Transport \(Mass, Loading and Access\) Regulation 2005](#) or under a regulation that replaces that regulation.
- (3) In this clause:

dimension limit means a provision of this Regulation that limits or otherwise regulates the dimensions of any registrable vehicle (or any load or projection of the vehicle).

91 Special provisions relating to boat trailers

- (1) Any trailer constructed or that is being used for the conveyance of a boat is taken to comply with an affixing provision if the affixed item is securely affixed to a removable panel or panels constructed of wood, metal or other suitable material and the panel or

panels are:

- (a) while a boat is being carried on the trailer—securely affixed to the boat in such a manner that the affixed item is in a position and is facing in a direction which would comply with the provisions of this Regulation if the boat comprised part of the trailer, and
- (b) while a boat is not being carried on the trailer—securely affixed to the trailer in such a manner that the affixed item is in a position and is facing in a direction which complies with the provisions of this Regulation.

(2) In this clause:

affixed item, in relation to an affixing provision, means any number-plate, fitting for the number-plate, trader's plate, registration label, holder for a registration label, light, reflector or flashing light turn signal to which the affixing provision applies.

affixing provision means any provision of this Regulation relating to:

- (a) the affixing of and any fitting for a number-plate or trader's plate or a registration label or a holder for such a label, or
- (b) the affixing of and any fitting for any light, reflector or flashing light turn signal required or permitted by this Regulation to be fitted to the trailer.

91A Photographic evidence of unauthorised vehicle use: section 135 of Act

The following offences against this Regulation are prescribed for the purposes of the definition of **unauthorised vehicle use offence** in section 135 (1) of the Act:

- (a) an offence against clause 50 (3),
- (b) an offence against clause 84 (3),
- (c) an offence against clause 84 (5).

92, 93 (Repealed)

94 Savings and transitional provisions

- (1) Any act, matter or thing that had effect under the repealed Regulation immediately before its repeal is taken to have effect under this Regulation.

Note—

The *Road Transport (Vehicle Registration) Regulation 1998* contained a Schedule of savings and transitional provisions. The transitional provisions are now spent, but certain savings provisions (such as those referred to in subclause (2)) are of continuing effect.

- (2) In particular, and without limiting subclause (1):
 - (a) an authority held, or taken to be held, as an examiner's authority under clause 63

of the repealed Regulation immediately before its repeal, and

(b) an authority held, or taken to be held, as a proprietor's authority under clause 64 of the repealed Regulation immediately before its repeal, and

(c) a rule in force, or taken to be in force, under clause 65 of the repealed Regulation immediately before its repeal,

are taken to be examiners' authorities, proprietors' authorities and rules held or in force under clauses 58, 59 and 60, respectively, of this Regulation.

(3) The form prescribed by Schedule 3 to the repealed Regulation, as in force immediately before the repeal of that Regulation, is taken to be a form approved for the purposes of clause 47 of this Regulation until such time as the Authority approves a different form for the purposes of that clause.

(3A) A reference in clause 41 (2A), as inserted by the *Road Transport (Vehicle Registration) Amendment (Suspension of Registration) Regulation 2011*, to any 3 year period is taken to be a reference to any 3 year period beginning on or after (but not before) the commencement of that Regulation.

(4) In this clause, **the repealed Regulation** means the *Road Transport (Vehicle Registration) Regulation 1998*.

95 (Repealed)

Schedule 1 Application of Chapter 4 of Act and Regulation

(Clause 4)

Part 1 General

1 Definitions

In this Schedule:

registration provisions means the provisions of this Regulation concerning the registration of registrable vehicles (including the issue and use of number-plates and the use of unregistered vehicles).

2 Suspension of exemptions

The Authority may suspend, either indefinitely or for such period as it thinks fit, the operation of clauses 9 and 11 in relation to any registrable vehicle to which any of those clauses would, but for this clause, apply if, having regard to any of the matters referred to in clauses 41 (1), (2), (2A) and (2B) and 41A of this Regulation, the Authority considers such action desirable in the public interest.

3 Application of section 18 (1) of Act to Part 2 vehicles

- (1) The use of an unregistered registrable vehicle on a road or road related area is permitted under this Regulation for so long as the vehicle is a vehicle to which the registration provisions do not apply by reason of any provision of Part 2.
- (2) Without limiting subclause (1), such use of such a vehicle ceases to be permitted under this Regulation if at any time the registration provisions become applicable to the vehicle because the vehicle does not comply with an applicable condition or requirement of Part 2.

Note—

Section 68 (1) of the Act makes it an offence for a person to use an unregistered registrable vehicle on a road. A vehicle is unregistered if it is not registered on the NSW registrable vehicles register. However, section 68 (2) (b) provides that section 68 (1) does not apply to the use of a registrable vehicle on a road if the use is otherwise permitted by the Act or under the statutory rules.

Part 2 Vehicles not subject to registration provisions

4 Vehicles on tow trucks

The registration provisions do not apply to a registrable vehicle under tow by a tow truck operating as a tow truck.

5 Vehicles used for work on farms

- (1) The registration provisions do not apply to:
 - (a) an agricultural implement towed by another vehicle, or
 - (b) a trailer towed by an agricultural machine operating as an agricultural machine.
- (2) In this clause:

agricultural implement means a vehicle without its own automotive power, built to perform agricultural tasks.

agricultural machine means a machine with its own automotive power, built to perform agricultural tasks.

Note—

Examples of agricultural implements are irrigating equipment, augers, conveyors, harvester fronts, harvest bins and machinery fully carried on the three-point linkage of a tractor.

Examples of agricultural machinery are tractors and harvesters.

6 Vehicles using roads or road related areas to a limited extent in context of primary production

The registration provisions do not apply to any registrable vehicle being driven across any

road or road related area when travelling to or from land that is being used solely or mainly for the purpose of primary production.

7 Certain trailers used for roadmaking and other public works

- (1) The registration provisions do not apply to any trailer that is hauled by a motor vehicle that is registered and is used solely:
- (a) for the purposes of road construction, maintenance (including cleansing, sweeping, watering or any similar process) or repair, or
 - (b) on a public park or on land dedicated or reserved from sale by the Crown for public health, recreation, enjoyment or other public purposes of a like nature, or on land owned by or leased to or vested in a local council or the Crown, for rolling tennis courts, cricket wickets, lawns or pathways or improving the surface of the ground or for similar work, and not let out on hire,

and which is used on any road or road related area solely while at, or proceeding to or returning from, the place where the road construction, maintenance or repair or other work is performed.

- (2) Subclause (1) does not apply to a trailer that is:
- (a) a vehicle constructed, or used, primarily for the conveyance of any goods or materials, or
 - (b) a caravan being used for tours for recreation purposes.

8 Golf and green keeping vehicles

- (1) The registration provisions do not apply to any golf vehicle or green keeping vehicle being driven directly across a road or road related area that intersects with or traverses a golf course if the vehicle:
- (a) is being used in the course of, or as an incident to, a game of golf or to observe any such game, or
 - (b) is proceeding to or from the golf course to be used for or in connection with the rolling or maintenance or surface improvement of any part of the golf course, or
 - (c) is proceeding to or from a car park or storage building that is separated from the golf course by the road or road related area.

- (2) In this clause:

golf course means an area of land (which includes tees, fairways, greens, rough, pathways, bunkers and bridges) designed and used for the playing of golf.

golf vehicle means:

- (a) a motorised buggy or cart that is designed and used to carry any golfer, spectator or golfing equipment on a golf course, or
- (b) a motor bike having an engine capacity not exceeding 50 millilitres that is used to carry a golfer, spectator or golf equipment on a golf course, or
- (c) any trailer that is being drawn by any such vehicle.

green keeping vehicle means any vehicle used solely or principally for or in connection with the rolling or maintenance or surface improvement of any part of a golf course.

9 Vehicles temporarily in New South Wales

- (1) The registration provisions do not apply to a registrable vehicle that meets the requirements of subclause (2) and that:
 - (a) is temporarily in New South Wales, and
 - (b) is:
 - (i) registered in another State or a Territory or in a foreign country, or
 - (ii) if unregistered—permitted to be used in accordance with an interstate permit law or interstate trader’s plate law.
- (2) The requirements to be met by a registrable vehicle referred to in subclause (1) are:
 - (a) that the vehicle carry, conspicuously displayed in the required manner and condition, all number-plates and labels that it is at that time required to carry:
 - (i) in the case of a vehicle registered outside this jurisdiction—in the other State, Territory or country in which it is registered, or
 - (ii) in the case of an unregistered vehicle permitted to be used in another State or a Territory—in that State or Territory,under a law of that State, Territory or country, as the case may be, and
 - (b) in the case of a vehicle described in subclause (1) (b) (ii)—that the vehicle is used in accordance with any conditions of any permit or other authority that apply in the State or Territory, so far as they are capable of being applied to the use of the vehicle outside that State or Territory.
- (3) The registration provisions will apply to a registrable vehicle referred to in subclause (1) if at any time the vehicle does not comply with, or ceases to comply with, one or more of the requirements of subclause (2).

Note—

For example, the registration provisions will apply to a registrable vehicle referred to in subclause (1) if the

vehicle ceases to carry conspicuously displayed in the required manner and condition all number-plates and labels that it is at that time required to carry in the jurisdiction where the vehicle is registered.

(4) In this clause:

interstate permit law means a law of another State or Territory that substantially corresponds to the provisions of this Regulation concerning unregistered vehicle permits.

interstate trader's plate law means a law of another State or a Territory that substantially corresponds to the provisions of this Regulation concerning trader's plates.

10 Vehicles registered under the [Interstate Road Transport Act 1985 \(Cth\)](#)

The registration provisions do not apply to any registrable vehicle registered under the [Interstate Road Transport Act 1985](#) of the Commonwealth that has affixed to it a plate or compliance plate as required by the regulations made under section 13 (1) (a) of that Act:

- (a) while the vehicle is engaged in the ***carriage of passengers or goods between prescribed places*** within the meaning of that Act, or
- (b) while the vehicle is being driven or left standing for any purpose that is incidental to that carriage.

11 Trailers towed by motor vehicles registered in Victoria

The registration provisions do not apply to any trailer (other than a trailer used to carry a boat) that:

- (a) is being towed by a motor vehicle that is registered in Victoria, and
- (b) is exempt from registration in Victoria, and
- (c) is not used in the course of trade, and
- (d) weighs less than 200 kilograms unladen, and
- (e) has a manufactured width that does not exceed the width of the vehicle towing the trailer, and
- (f) is of a length (including the draw bar and any load) that does not exceed 3 metres, and
- (g) if it obscures the number-plate of that motor vehicle—displays (whether by painting or otherwise) on its rear the registration number of the vehicle so that the number is clearly distinguishable at a distance of 20 metres from the rear.

12 Vehicles used to fight rural fires

The registration provisions do not apply to any registrable vehicle that is used on a road or road related area if the vehicle:

- (a) is attached to a rural fire brigade formed under the [Rural Fires Act 1997](#) and has painted on it, or securely affixed to it, a sign clearly identifying the rural fire brigade to which it is attached, and
- (b) is used to convey persons or equipment to or from the work of preventing, mitigating or suppressing fires in rural fire districts (including clearing fire breaks or removing inflammable material), and
- (c) is travelling on the road or road related area for the purpose referred to in paragraph (b) or any of the following purposes:
 - (i) to attend a fire, incident or other emergency in accordance with the [Rural Fires Act 1997](#),
 - (ii) to assist other emergency services organisations (within the meaning of the [State Emergency and Rescue Management Act 1989](#)) at incidents and at emergencies under the control of those organisations,
 - (iii) to convey persons or equipment for the purpose of training those persons in relation to any of the purposes referred to in this paragraph,
 - (iv) for a purpose necessary or incidental to the service or repair of the vehicle,
 - (v) to perform such other functions of the NSW Rural Fire Service as the Commissioner of the NSW Rural Fire Service or a fire control officer within the meaning of the [Rural Fires Act 1997](#) may approve for the purposes of the exemption.

13 Police vehicles

The registration provisions do not apply to any registrable vehicle that is being used in connection with police work and to which is affixed a number-plate issued by the Authority for the purpose of being substituted for the number-plate that would otherwise be required to be affixed to the vehicle by this Regulation.

14 Lawn mowers

The registration provisions do not apply to any registrable vehicle, weighing not more than 250 kilograms when unladen, that is constructed or used solely for cutting grass or for purposes incidental to cutting grass.

15 Power-assisted pedal cycles

The registration provisions do not apply to any registrable vehicle that is a power-assisted

pedal cycle within the meaning of vehicle standards, as amended from time to time, determined under section 7 of the *Motor Vehicle Standards Act 1989* of the Commonwealth other than one that has an internal combustion engine or engines.

Note—

Power-assisted pedal cycle is defined in the *Vehicle Standard (Australian Design Rule - Definitions and Vehicle Categories) 2005* determined under section 7 of the *Motor Vehicle Standards Act 1989* of the Commonwealth. The definition of **power-assisted pedal cycle** includes pedalecs within the meaning of that Standard (which may have one or more auxiliary propulsion motors generating a combined power output not exceeding 250 watts).

16 Vehicles used by certain disabled persons

The registration provisions do not apply to any registrable vehicle that:

- (a) is specially constructed to be used, and while on a road or road related area is used, solely for the conveyance of a person with a disability that substantially impairs the person's mobility, and
- (b) is not capable of travelling at more than 10 kilometres per hour.

17 Vehicles being driven to registration and associated places

- (1) The registration provisions do not apply to any registrable vehicle while it is being driven for the purpose of obtaining registration of the vehicle by the most direct or convenient route:
 - (a) to the nearest convenient motor registry, or
 - (b) to the nearest convenient vehicle inspection station or authorised inspection station to determine whether the registrable vehicle complies with the applicable vehicle standards for that vehicle, or
 - (c) in the course of inspection or testing of the motor vehicle for the purpose of making the determination referred to in paragraph (b), or
 - (d) to the nearest practicable weighbridge to determine the weight of the motor vehicle, or
 - (e) from a motor registry or from a vehicle inspection station or authorised inspection station where registration of the vehicle has been refused for any purpose to the nearest convenient place at which necessary repairs and adjustments to the vehicle may be effected or at which the vehicle may be garaged (except where the condition of the vehicle is such that a direction has been issued that the vehicle must not be driven on a road or road related area before necessary repairs are effected), or
 - (f) to the nearest convenient office of a licensed insurer within the meaning of the *Motor Accidents Compensation Act 1999* for the purpose of obtaining third party

insurance for the vehicle in accordance with that Act, or

(g) to the nearest convenient location for any other purpose directly associated with the registration process.

(2) (Repealed)

(3) The registration provisions do not apply to a registrable vehicle that:

(a) is being driven for the purpose of obtaining an unregistered vehicle permit, and

(b) is proceeding by the most direct or convenient route to the nearest place at which a permit can be obtained under this Regulation,

until it reaches that place.

(4) In this clause, **direct or convenient route** includes the route to the nearest place at which the registrable vehicle can be weighed or inspected for the purpose of obtaining registration.

18 Vehicles that are being inspected

The registration provisions do not apply to any registrable vehicle the registration of which has expired but to which the number-plates are still affixed while the vehicle is being driven by an authorised examiner to determine whether the vehicle complies with the applicable vehicle standards for the vehicle.

Part 3 Vehicles to which Chapter 4 of Act does not apply

19 Light rail vehicles

Chapter 4 of the Act does not apply to any light rail vehicle.

20 Self-propelled elevating work platforms

(1) Chapter 4 of the Act does not apply to a self-propelled elevating work platform.

(2) In this clause:

self-propelled elevating work platform means a self-propelled vehicle used for construction, maintenance or warehouse operations that:

(a) is designed mainly for use otherwise than on a road or road related area, and

(b) is not capable of travelling at a speed in excess of 10 kilometres per hour, and

(c) is being used only for the purpose for which it is manufactured, and

(d) is not being used for transport on a road or road related area other than for the purposes of loading the vehicle onto another vehicle or unloading it from another

vehicle or repositioning it at a work site.

Schedule 2 Vehicle standards

(Clause 51)

Part 1 Introductory

Division 1 Object of vehicle standards

1 Object of vehicle standards

- (1) The object of this Schedule is to set standards about the construction and performance of motor vehicles, trailers and combinations that are uniform throughout Australia.
- (2) The standards set by this Schedule are intended:
 - (a) to promote, throughout the life of motor vehicles, trailers and combinations, their safe use and efficiency and protection of the environment, and
 - (b) to reduce the cost of transport administration.

Division 2 General

1A Limited application of Schedule

- (1) This Schedule applies to light vehicles only, except as provided by subclause (2).
- (2) Clause 61 applies to all registrable vehicles, including heavy vehicles within the meaning of the *Heavy Vehicle National Law (NSW)*.

2 Application of Division

- (1) Subject to this clause and except where the context of this Schedule otherwise indicates or requires, a registrable vehicle that is, or is to be, driven on a road or road related area:
 - (a) must be provided with the items of equipment appropriate for the vehicle set out in, and conforming with the provisions of, this Schedule, and
 - (b) must be so constructed and equipped that it will comply with all other provisions appropriate to the vehicle that are specified in this Schedule.
- (2) The provisions of this Schedule (other than this clause) do not apply to any plant that is not constructed on a chassis normally used in the construction of a motor lorry.
- (3) However, any such plant must comply with any vehicle standards or technical specifications approved by the Authority in relation to the plant.

(4) In this clause:

plant means a motor vehicle that wholly comprises:

- (a) a machine or implement that is not capable of carrying any load other than tools and accessories usually carried, or
- (b) a crane or a fork lift truck.

3 Non-application of Schedule—exemption under other laws

- (1) A provision of this Schedule does not apply to a vehicle or combination if the vehicle or combination is exempt from:
 - (a) the provision under another law of this jurisdiction, or
 - (b) the corresponding provision of the law of another jurisdiction.
- (2) However, the vehicle or combination is exempt only if all conditions of the exemption (if any) are being complied with.

4 Non-application of Schedule—Motor Vehicle Standards Act approvals

A provision of Parts 2 to 10 does not apply to a vehicle if:

- (a) the vehicle does not comply with a requirement of an ADR applying to that vehicle, and
- (b) the provision of this Schedule corresponds to the requirement of the ADR, and
- (c) despite the non-compliance, approval has been given, under subsection 10A (2) or (3) of the *Motor Vehicle Standards Act 1989* of the Commonwealth, to place identification plates on vehicles of that type, and
- (d) the vehicle complies with the approval conditions (if any).

Note—

Section 10A (2) of the *Motor Vehicle Standards Act 1989* of the Commonwealth deals with vehicles that do not comply with an ADR, but the non-compliance is only in minor and inconsequential respects.

Section 10A (3) of that Act deals with vehicles that do not comply with an ADR and the non-compliance is not minor and inconsequential, but the Minister responsible for that Act is satisfied that vehicles of that type comply with the national standards to an extent that makes them suitable for supply to the market.

5 Interpretation

- (1) A diagram in this Schedule is part of this Schedule. A diagram of something is an illustrative example of the thing in black and white, but does not represent its dimensions or the dimension of any part of it.
- (2) An example (whether or not in the form of a diagram) in this Schedule is part of this

Schedule.

- (3) If a clause in this Schedule includes an example of the operation of that clause:
- (a) the example is not exhaustive, and
 - (b) the example does not limit, and may extend, the meaning of the clause, and
 - (c) the example and the clause are to be read in the context of each other and of the other clauses of this Schedule, but, if the example and the clause as so read are inconsistent, the clause prevails.

6 References to registration before the commencement of Act

A reference in this Schedule to the registration of a vehicle on a date occurring before the commencement of the Act is taken to be a reference to its registration under the [Traffic Act 1909](#) before that date.

7 Date of manufacture of vehicle

If, in respect of a registrable vehicle imported into Australia, an application is or was made in New South Wales:

- (a) on or after 1 January 1984, for registration of the vehicle as a public passenger vehicle, or
- (b) (Repealed)

the date of manufacture of the vehicle is, for the purposes of this Schedule, taken to be the date of entry of the vehicle into Australia.

8 Optional items

If in a provision of this Schedule, a second edition ADR or a third edition ADR it is provided or indicated that any item of equipment is optional and the item is used on a registrable vehicle to which the provision is applicable, the item must conform with the requirements of that provision.

9 Special requirements for vehicles used by disabled persons

The Authority may require that any registrable vehicle be specially constructed, equipped or adapted in a manner not provided for in this Schedule if:

- (a) it is to be used by a person who is suffering from a physical disability, or
- (b) it is to be used in such other circumstances as may be necessary in the interests of public safety.

10 Authority may exempt vehicle from requirement of Schedule

- (1) The Authority may exempt any particular vehicle or class of vehicle from any requirement of this Schedule.
- (2) An exemption may be granted subject to conditions.
- (3) The Authority may amend or revoke an exemption or a condition made or imposed in accordance with this clause.

Division 3 Australian Design Rules and other standards

11 Compliance with second edition ADRs

- (1) If a second edition ADR recommends that the ADR should apply to the design and construction of a vehicle, the vehicle must comply with the ADR.
- (2) If a second edition ADR contains a requirement for a type of equipment fitted to a vehicle built on or after a stated time, any equipment of the same type fitted to the vehicle after it is built must comply with:
 - (a) the requirement as in force when the vehicle was built, or
 - (b) if the requirement is amended after the vehicle is built and before the equipment is fitted—the requirement as in force:
 - (i) when the vehicle was built, or
 - (ii) when the equipment was fitted, or
 - (iii) at any time between when the vehicle was built and the equipment was fitted.
- (3) However, a vehicle, or equipment fitted to a vehicle, need not comply with a recommendation or requirement of a second edition ADR if:
 - (a) the recommendation or requirement is replaced by, or is inconsistent with, a requirement of a third edition ADR applying to the vehicle or equipment, and
 - (b) the vehicle or equipment complies with the requirement of the third edition ADR.
- (4) If a second edition ADR allows a vehicle built on or after a stated time to be fitted with equipment, a vehicle built before that time may also be fitted with the equipment.

12 Compliance with third edition ADRs

- (1) If a third edition ADR applies to the design and construction of a vehicle, the vehicle must comply with the ADR.
- (2) If a third edition ADR contains a requirement for a type of equipment fitted to a vehicle built on or after a stated time, any equipment of the same type fitted to the

vehicle after it is built must comply with:

- (a) the requirement as in force when the vehicle was built, or
 - (b) if the requirement is amended after the vehicle is built and before the equipment is fitted—the requirement as in force:
 - (i) when the vehicle was built, or
 - (ii) when the equipment was fitted, or
 - (iii) at any time between when the vehicle was built and the equipment was fitted.
- (3) However, a vehicle, or equipment fitted to a vehicle, need not comply with a requirement of a third edition ADR if:
- (a) the requirement is replaced by, or is inconsistent with, a requirement of a later version of the ADR applying to the vehicle or equipment, and
 - (b) the vehicle or equipment complies with the requirement of the later version.
- (4) If a third edition ADR allows a vehicle built on or after a stated time to be fitted with equipment, a vehicle built before that time may also be fitted with the equipment.

13 Exception to compliance with ADRs—vehicles that are not road vehicles

A vehicle need not comply with an ADR applied by clause 11 (1) or 12 (1) if a determination or declaration under section 5B of the *Motor Vehicle Standards Act 1989* of the Commonwealth provides that the vehicle is not a road vehicle for the purposes of that Act.

14 Exception to compliance with ADRs—Motor Vehicle Standards Act

- (1) A vehicle need not comply with an ADR applied by clause 11 (1) or 12 (1) if:
- (a) despite non-compliance with the ADR, approval has been given, under subsection 10A (2) or (3) of the *Motor Vehicle Standards Act 1989* of the Commonwealth, to place identification plates on vehicles of that type, and
 - (b) the vehicle complies with the approval conditions (if any).

Note—

See note to clause 4.

- (2) A vehicle need not comply with an ADR applied by clause 11 (1) or 12 (1) if:
- (a) the vehicle may be supplied to the market under section 14A (1) of the *Motor Vehicle Standards Act 1989* of the Commonwealth, and
 - (b) for a vehicle for which an approval has been given under that subsection—the

vehicle complies with the approval conditions (if any).

- (3) A vehicle need not comply with an ADR applied by clause 11 (1) or 12 (1) if:
- (a) the vehicle may be used in transport in Australia under section 15 (2) of the *Motor Vehicle Standards Act 1989* of the Commonwealth, and
 - (b) for a vehicle for which an approval has been given under that subsection—the vehicle complies with the approval conditions (if any).

15 Partial exception to compliance with ADRs—personally imported vehicles

- (1) A personally imported vehicle must be fitted with:
- (a) seatbelts that are as effective as seatbelts that meet an Australian Standard or British Standard for seatbelts as in force on 29 June 1998, and
 - (b) seatbelt anchorages that meet the number and location requirements of second or third edition ADR 5, and
 - (c) child restraint anchorages that meet the number, location, accessibility, thread size and form requirements of second edition ADR 34 or third edition ADR 5 or 34, and
 - (d) head restraints that meet the number, location and size requirements of second or third edition ADR 22.
- (2) However, a personally imported vehicle need only meet the requirements of an ADR mentioned in subclause (1) if the ADR recommends that it should apply, or applies, to a vehicle of the same type.
- (3) A personally imported vehicle need not otherwise comply with an ADR applied by clause 11 (1) or 12 (1).

16 Alteration of specifications

- (1) A car or motor car derivative must not be altered from its specifications, as originally manufactured, so that it no longer complies with the requirements of a second edition ADR or third edition ADR applicable to that vehicle or altered in any of the following respects:
- (a) by fitting a wheel rim that does not conform to the relevant dimensional standards for wheel rims set down in the Tyre and Rim Standards Manual issued by the Tyre and Rim Association of Australia,
 - (b) by widening the wheel track of the front or rear wheels by more than 25 millimetres beyond the maximum specified by the axle or vehicle manufacturer,
 - (c) by fitting a wheel nut that does not engage the thread of the wheel stud for at

least the same length as the wheel nut provided by the vehicle manufacturer or by fitting a wheel nut that does not match the taper on the wheel stud hole,

- (d) by fitting a tyre other than that appropriate to the wheel rim as specified in the Tyre and Rim Standards Manual issued by the Tyre and Rim Association of Australia or in any applicable second edition ADR or third edition ADR,
 - (e) so that any part of it other than a tyre or wheel rim will contact a road surface in the case of the complete deflation of a tyre,
 - (f) by welding or heating an axle, stub axle, steering arm or steering knuckle support.
- (2) A vehicle, other than a car or motor car derivative, must not be altered from its specifications, as originally manufactured, so that it no longer complies with the requirements of a second edition ADR or a third edition ADR applicable to that vehicle.
- (3) If a vehicle is altered from its specifications, as originally manufactured, the Authority may require the owner to supply such information about the alterations as the Authority considers necessary.
- (4) Despite subclauses (1) and (2), a vehicle may be altered from its specifications as originally manufactured if the alteration only gives effect to any subsequent second edition ADR or third edition ADR applicable to a vehicle of that category.

17 Compliance with third edition ADR as alternative to compliance with Schedule

Nothing in Parts 2 to 12 prevents a registrable vehicle from being constructed and equipped so as to comply with any relevant requirement of a provision of a third edition ADR as an alternative to being constructed and equipped to comply with any relevant requirements of a corresponding provision of Parts 2 to 12.

18 What is an adopted standard

An **adopted standard** is a standard, except a national standard, that is applied, adopted or incorporated by this Schedule.

Example

Clause 67 (7) adopts Australian/New Zealand Standard AS/NZS 1906.1:2007 *Retroreflective materials and devices for road traffic control purposes—Retroreflective sheeting*.

19 Exception to compliance with adopted standards

A vehicle need not comply with an adopted standard if:

- (a) the standard is replaced by, or is inconsistent with, a later version of the standard, and
- (b) the vehicle complies with the later version of the standard.

20 References to adopted standards and national standards

- (1) Unless the contrary intention appears, a reference in a clause or subclause to an adopted standard is a reference to the standard as in force when the clause or subclause commenced.
- (2) Unless the contrary intention appears, a reference in this Schedule to a national standard is a reference to the standard as in force from time to time.

Part 2 General safety requirements

Division 1 All vehicles

21 General requirement to keep vehicles in good order

In addition to complying with the requirements of this Schedule, the weight of any registrable vehicle and everything in its construction, form, equipment, working and general condition must be such that:

- (a) it will not contravene any provision of any Act or other law, and
- (b) it will not cause danger or unreasonable annoyance to any person.

22 Steering

- (1) (Repealed)
- (2) A motor vehicle must have a right-hand drive if the vehicle:
 - (a) is less than 30 years old, and
 - (b) is required under a law of this jurisdiction to have a right-hand drive.
- (3) A motor vehicle has a right-hand drive if the centre of at least 1 steering control of the vehicle is to the right of, or in line with, the centre of the vehicle.
- (4) A component of the steering system of a motor vehicle that is essential for effective steering of the vehicle must be built to transmit energy by mechanical means only.
- (5) Failure of a non-mechanical component of the steering system must not prevent effective steering of the vehicle.
- (6) This clause does not apply to a vehicle if the vehicle is built or used mainly for a purpose other than the transport of goods or people by road.

23 Turning ability

- (1) A motor vehicle must be able to turn in a circle not over 25 metres in diameter, measured by the outer edge of the tyre track at ground level.

- (2) The vehicle must be able to comply with subclause (1) whether it turns to the left or to the right.

24 Ability to travel backwards and forwards

A motor vehicle with an unloaded mass over 450 kilograms must be able to be driven both backwards and forwards when the driver is in the normal driving position.

25 Protrusions

- (1) An object fitted to a vehicle must be designed, built and fitted to the vehicle in a way that minimises the likelihood of injury to a person making contact with the vehicle.
- (2) However, subclause (1) does not apply to an object fitted to a vehicle if:
 - (a) the vehicle was designed before 1965 and the object was part of the design of the vehicle, or
 - (b) the object was fitted to the vehicle before 1965 in accordance with the law of the place where the object was fitted.
- (3) A vehicle frontal protection system that is fitted on a motor vehicle that:
 - (a) has a GVM not over 3.5 tonnes, and
 - (b) is manufactured on or after 1 January 2003,must comply with AS 4876.1-2002 *Motor vehicle frontal protection systems—Road user protection* (except clause 3.2).
- (4) Subclause (3) does not apply to a vehicle frontal protection system fitted on a motor vehicle if the model of the vehicle is a model of a kind manufactured before 1 January 2003.
- (5) In this clause:

vehicle frontal protection system means a structure fitted to the front of a vehicle to reduce damage to the vehicle structure and systems in the event of either a front-end impact or an animal strike.

Note—

Examples of vehicle frontal protection systems are bullbars, roobars and nudge bars. Vehicle frontal protection systems may be fitted in front of, or in place of, vehicle bumpers.

26 Oil and grease not to be dropped

All parts and fittings of a motor vehicle or trailer must be such that an undue amount of oil or grease will not be dropped onto the roadway.

27 Driver's view and vehicle controls

A motor vehicle must be built:

- (a) to allow the driver a view of the road and of traffic to the front and sides of the vehicle so the driver can drive the vehicle safely, and
- (b) with its controls located so the driver can drive the vehicle safely.

28 Seating

A seat for a driver or passenger in a vehicle must be securely attached to the vehicle.

29 Seatbelts for cars registered between 1 January 1965 and 1 January 1969

Every car and motor car derivative first registered on or after 1 January 1965 and before 1 January 1969 must be equipped for each front seat position that is adjacent to the side of the vehicle with a seatbelt that:

- (a) has been installed in accordance with instructions issued by the manufacturer of the seatbelt, and
- (b) at the time of its installation has not previously been installed and used in a motor vehicle, and
- (c) is of:
 - (i) a type referred to in Australian Standard AS E35/BWG-1966 *Drawings for bollard type webbing grips for testing car seat belt webbing* as a Combination Belt (High) and has been manufactured in accordance with that Standard, or
 - (ii) some other type approved by the Authority.

30 Child restraint anchorage bolts in drive yourself vehicles

- (1) Every motor vehicle that is a drive yourself vehicle must be fitted with a child restraint anchorage bolt of a type approved by the Authority.
- (2) A child restraint anchorage bolt referred to in this clause must be fitted to a child restraint anchorage point if the vehicle is one required by the second edition ADRs or third edition ADRs to have a child restraint anchorage.
- (3) In this clause:

drive yourself vehicle means a motor vehicle that is let for hire (other than under a hire purchase agreement) without the services of a driver and that does not stand in a public street for hire, other than a motor cycle, a trailer or a motor vehicle that:

- (a) is used in connection with the work of any hospital or charitable, benevolent or religious institution by or on behalf of the authority controlling that hospital or

institution, and

- (b) is operated in connection with a community transport project approved by the Minister.

31 Door latches and hinges

Door latches and hinges on every vehicle must be so constructed that the doors are securely affixed to the vehicle and capable of remaining securely fastened when closed.

32 Mudguards and spray suppression

- (1) A vehicle must have firmly fitted a mudguard for each wheel or for adjacent wheels.
- (2) However, subclause (1) does not apply to a vehicle if:
 - (a) the construction or use of the vehicle makes the fitting of mudguards unnecessary or impracticable, or
 - (b) the body or part of the body of the vehicle acts as a mudguard.
- (3) A mudguard fitted to a vehicle must, when the wheels of the vehicle are in position to move straight ahead:
 - (a) reduce the danger of a person contacting the moving wheels, and
 - (b) for the rear wheels:
 - (i) cover the overall tyre width of the wheel or wheels to which it is fitted, and
 - (ii) be fitted so the height above ground level of the lowest edge of the rear of the mudguard is not over one-third of the horizontal distance between the edge and the centre of the rearmost axle.
- (4) However, a mudguard may be up to:
 - (a) 230 millimetres above ground level, or
 - (b) on a vehicle built to be used off-road—300 millimetres above ground level.
- (5) The outside of a rear mudguard, except a mudflap, of a vehicle that can be seen from the rear of the vehicle must be coloured white or silver if the vehicle:
 - (a) is at least 2.2 metres wide, and
 - (b) has a body the vertical measurement of which is under 300 millimetres at the rear, measured from the lowest point of the body above ground level to the highest point, and
 - (c) is not fitted with rear marking plates in accordance with clause 127.

- (6) For subclause (5) (a), the width of a vehicle is measured disregarding any anti-skid device mounted on wheels, central tyre inflation systems, lights, mirrors, reflectors, signalling devices and tyre pressure gauges.

33 Horns, alarms and the like

- (1) A motor vehicle must be fitted with at least 1 horn or other device that can give sufficient audible warning to other road users of the approach or position of the vehicle.
- (2) A motor vehicle must not be fitted with a device that can make a sound like the sound of a siren, exhaust whistle, compression whistle or repeater horn.
- (3) However, subclause (2) does not apply to:
- (a) a police vehicle, or
 - (b) an emergency vehicle, or
 - (c) an Australian Protective Service vehicle, or
 - (d) an Australian Customs Service vehicle, or
 - (e) an Airservices Australia vehicle, or
 - (f) a vehicle at least 25 years old that is fitted as a police or emergency vehicle if:
 - (i) the vehicle is used for exhibition purposes, or
 - (ii) it is part of a collection of former police or emergency vehicles, or
 - (g) an anti-theft alarm if the alarm cannot be operated while the vehicle's ignition is on, or
 - (h) a vehicle used by a Traffic Commander or a Traffic Emergency Patroller appointed or employed by the Authority.
- (4) Also, a motor vehicle may be fitted with a device that emits a regular, intermittent sound while the vehicle is reversing or in reverse gear.
- (5) The device must not be louder than is necessary so the driver, and a person near the vehicle, can hear the device when it is operating.

34 Rear vision mirrors

- (1) A rear vision mirror or mirrors must be fitted to a motor vehicle as required by this clause so that a driver of the vehicle can clearly see by reflection the road behind the vehicle and any following or overtaking vehicle.
- (2) At least 1 rear vision mirror must be fitted to:

- (a) a car, and
 - (b) a motor trike with 2 front wheels, and
 - (c) a motor bike, or motor trike with 1 front wheel, built before July 1975.
- (3) At least 1 rear vision mirror must be fitted to each side of the motor vehicle:
- (a) if the vehicle has a GVM over 3.5 tonnes, or
 - (b) if the vehicle is a motor bike, or motor trike with 1 front wheel, built after June 1975, or
 - (c) if the vehicle is constructed for the carriage of goods (not being a station wagon),
or
 - (d) if the vehicle is a bus, or
 - (e) if the maximum width of any trailer or other vehicle drawn by the vehicle is greater than that of the vehicle, or
 - (f) if because of the manner in which the vehicle is constructed, equipped or loaded, or because of the fact that the vehicle is drawing a trailer or other vehicle, or for any other reason, the driver cannot, by means of a mirror fixed to the interior of the vehicle, have reflected to him or her as far as practicable a clear view of the road to the rear of the vehicle and of any following or overtaking vehicle.
- (4) A motor vehicle with a GVM not over 3.5 tonnes (except a motor vehicle mentioned in subclause (2) or (3)) must be fitted with:
- (a) at least 1 rear vision mirror on the right side of the vehicle, and
 - (b) at least 1 rear vision mirror on the left side of the vehicle or inside the vehicle.
- (5) A rear vision mirror fitted to a motor vehicle with a GVM over 3.5 tonnes must not project over 150 millimetres beyond the widest part (excluding lights, signalling devices and reflectors) of the vehicle or combination.
- (6) However, the rear vision mirror may project not over 230 millimetres beyond the widest part of the vehicle or combination if it can fold to project not over 150 millimetres beyond the widest part.

35 Rear vision mirrors—surfaces

- (1) A rear vision mirror required to be fitted to the side of a motor vehicle with a GVM over 3.5 tonnes must have a reflecting surface of at least 150 square centimetres.
- (2) A rear vision mirror required to be fitted to the right side of a motor vehicle with a GVM over 3.5 tonnes must have a flat reflecting surface if:

- (a) the motor vehicle has only 1 steering control, and
 - (b) the centre of the steering control is to the right of, or in line with, the centre of the motor vehicle.
- (3) The reflecting surface of the rear vision mirrors that are required to be fitted to a motor bike or moped must:
- (a) each be of the same curvature, and
 - (b) if convex, be part of a notional sphere with a radius of at least 1.2 metres.

36 Additional rear vision mirrors

A motor vehicle may be fitted with additional rear vision mirrors or mirror surfaces that are flat or convex or a combination of flat and convex surfaces.

37 Automatic transmission

- (1) A motor vehicle fitted with an automatic transmission must have an engine starter mechanism that cannot operate when the transmission control is in a position to drive the vehicle.
- (2) A vehicle built after 1975 that is fitted with an automatic transmission must have an indicator in the driver's compartment showing the transmission control position.
- (3) Subclauses (1) and (2) do not apply to a motor vehicle with less than 4 wheels.
- (4) If a motor vehicle (other than a motor bike or an implement) manufactured on or after 9 January 1976 is equipped with automatic transmission:
 - (a) the transmission control lever position and an indication of the transmission gear ratio selected must be displayed within the driver's compartment in such a location that they will be readily visible to the driver, and
 - (b) the sequence of transmission control lever positions must:
 - (i) include a neutral position (whereby no power is transmitted to the driving wheels) located between the reverse drive and forward drive positions, and
 - (ii) in cases where a park position (whereby forward or rearward movement of the vehicle is prevented) is included, be such that the park position is located at the end of the sequence adjacent to the reverse drive position.
- (5) If a car or a motor car derivative manufactured on or after 9 January 1976 is equipped with automatic transmission:
 - (a) if the transmission control lever is located on the steering column:
 - (i) the movement of the lever from neutral to reverse must be clockwise except

that in cases where all lever positions are to the right of the vertical longitudinal plane through the centre of the steering wheel, the movement of the lever from neutral to reverse must be anti-clockwise, and

- (ii) the movement of the device provided to indicate the transmission gear ratio selected must be generally in the same linear or rotational direction as the movement of the lever, and
- (b) if the transmission control lever is located in a position other than on the steering column:
- (i) all lever positions must be to the left of the vertical longitudinal plane through the centre of the steering wheel, and
 - (ii) movement of the lever from neutral to reverse must be generally upwards, forward or to the left according to whether the lever is constrained to be moved generally in a vertical, longitudinal or transverse direction, as the case may be.

38 Diesel engines

A motor vehicle propelled by a compression ignition engine (commonly known as a diesel engine) must be fitted with a device preventing the engine from being started accidentally or inadvertently.

39 Bonnet securing devices

- (1) A motor vehicle with a moveable body panel forward of the windscreen that covers an engine or luggage storage or battery compartment must have a device to secure the panel.
- (2) However, if the panel opens from the front in a way that partly or completely obstructs the driver's forward view through the windscreen, the panel must have primary and secondary devices to secure the panel.

40 Electrical wiring, connections and installations

- (1) The wiring of electrical equipment of a vehicle, except the high tension ignition wiring, must:
 - (a) be supported at intervals of not over 600 millimetres, unless the vehicle is a pole-type trailer with a pole with an adjustable length, or an extendible trailer, and
 - (b) be insulated at each of its joints, and
 - (c) be located where it cannot:
 - (i) become overheated, or

- (ii) contact moving parts, or
 - (iii) come near enough to the fuel system to be a fire hazard, and
 - (d) be protected from chafing.
- (2) The electrical connectors between motor vehicles and trailers, for operation of the vehicle lights required by this Schedule, must comply with Australian Standard AS 4177.5-2004 *Caravan and light trailer towing components—Electrical connectors*.
- (3) A trailer must be equipped with an electrical conductor, independent of the trailer coupling, that provides a return path between the electrical circuits of the trailer and towing vehicle.
- (4) (Repealed)

41 Speedometers

Every motor vehicle (not being a trailer) manufactured on or after 1 July 1974 and capable of being driven at a speed in excess of 40 kilometres per hour on a level road must be fitted with a speedometer that must:

- (a) indicate the speed at which the vehicle is being driven in kilometres per hour, and
- (b) indicate, when the vehicle is travelling at a speed in excess of 50 kilometres per hour, a speed that is not more than 10% less than the actual speed, and
- (c) be readily visible to the driver.

42 Television receivers and visual display units

- (1) A television receiver or visual display unit must not be installed in a vehicle so any part of the image on the screen is visible to the driver from the normal driving position.
- (2) However, subclause (1) does not apply to:
- (a) a television receiver or visual display unit that cannot be operated when the vehicle is moving, or
 - (b) a driver's aid in any vehicle or a destination sign in a bus.
- (3) A television receiver, or visual display unit, and its associated equipment in a vehicle must be securely mounted in a position that:
- (a) does not obscure the driver's view of the road, and
 - (b) does not impede the movement of a person in the vehicle.

43 Windows generally

- (1) Every window must be sound and properly fitted and each movable window must be fitted with a suitable device to enable it to be opened and closed.
- (2) At least half of the number of windows must be capable of being opened.

44 Windscreens and windows

- (1) Transparent material used in a windscreen, window or an interior partition, of a motor vehicle must be of approved material if:
 - (a) the vehicle was built after June 1953, or
 - (b) the material was first fitted to the vehicle after June 1953.
- (2) Despite subclause (1), non-shatterable transparent material may be used in a window or an interior partition of a motor vehicle.
- (3) In this clause:

approved material means material with the same characteristics as material mentioned in any of the following:

- (a) Australian and New Zealand Standard AS/NZS 2080:2006 *Safety glazing for land vehicles*,
- (b) Australian and New Zealand Standard AS/NZS 2080:1995 *Safety glass for land vehicles*,
- (c) Australian Standard AS 2080-1983 *Safety glass for land vehicles* up to and including amendment No 1,
- (d) New Zealand Standard NZS 5443:1987 *Safety glass for land vehicles*,
- (e) Japanese Industrial Standard JIS R 3211:1998 *Safety glazing materials for road vehicles*,
- (f) Japanese Industrial Standard JIS R 3211-1992 *Safety glass for road vehicles*,
- (g) United Nations Economic Commission for Europe Regulation No 43 *Uniform provisions concerning the approval of safety glazing materials and their installation on vehicles* second revision as in force 12 August 2004,
- (h) United Nations Economic Commission for Europe Regulation No 43 *Uniform provisions concerning the approval of safety glazing materials and their installation on vehicles* Revision 1 of 25 February 1988,
- (i) British Standard BS AU178:1980 *Specification for road vehicle safety glass*,

- (j) American National Standard ANSI/SAE Z26.1-1996 *American National Standard for Safety Glazing Materials for Glazing Motor Vehicles and Motor Vehicle Equipment Operating on Land Highways - Safety Code*,
- (k) American National Standard ANSI/SAE Z26.1-1980 *American National Standard for Safety Glazing Materials for Glazing Motor Vehicles and Motor Vehicle Equipment Operating on Land Highways - Safety Code*.

transparent material does not include any coating added to the windscreen, window or partition after its manufacture.

45 Window tinting

- (1) Glazing used in a windscreen of a motor vehicle must have a luminous transmittance of at least:
 - (a) for a motor vehicle built after 1971—75%, or
 - (b) for any other motor vehicle—70%.
- (2) Windscreen glazing of a motor vehicle must not be coated in a way that reduces its luminous transmittance.
- (3) However, subclauses (1) and (2) do not apply to the greater of the following areas of a windscreen:
 - (a) the area above the highest point of the windscreen that is swept by a windscreen wiper, or
 - (b) the upper 10% of the windscreen.
- (4) Glazing used in a window or interior partition of a motor vehicle must have a luminous transmittance of at least 70%.
- (5) Glazing behind the rear of the driver's seat may be coated to achieve a luminous transmittance of not less than 35%.
- (6) Glazing in a side window forward of the rear of the driver's seat may be coated to achieve a luminous transmittance of not less than 70% or, if another law of this jurisdiction allows a lesser luminous transmittance, the greater of:
 - (a) the lesser luminous transmittance allowed under the other law, and
 - (b) 35%.
- (7) Glazing that has been coated to reduce its luminous transmittance must not have a reflectance of over 10%.
- (8) Despite clause 17, the luminous transmittance requirements in subclauses (5) and (6)

apply to a vehicle instead of the corresponding requirements in the relevant ADR.

46 Glazing in windscreens, windows and interior partitions

- (1) Clause 45 does not apply in relation to:
 - (a) any part of the glazing of a window (other than a windscreen) or interior partition of a motor vehicle that was first registered (whether or not in New South Wales) before 1 August 1994, if that part of the glazing has a luminous transmittance of not less than:
 - (i) 35% (except when subparagraph (ii) applies), or
 - (ii) the luminous transmittance it had immediately before 1 August 1994 if it had a luminous transmittance of less than 35% at that time, or
 - (b) any part of the glazing of a window (other than a windscreen) or interior partition of a motor vehicle that was first registered (whether or not in New South Wales) on or after 1 August 1994, if:
 - (i) that part of the glazing has a luminous transmittance of not less than 35%, and
 - (ii) the motor vehicle is equipped with an external rear vision mirror, or external rear vision mirrors, complying with the requirements of clause 34, or
 - (c) any part of the glazing of a window or interior partition in a caravan, or
 - (d) any part of the glazing of a windscreen, window or interior partition in a motor vehicle that was first registered before 1 July 1984, being glazing that was fitted to the motor vehicle on or before the date on which it was so registered.
- (2) For the purposes of clause 45 and this clause, the luminous transmittance or reflectance of glazing must be determined in accordance with the luminous transmittance test or the reflectance test, as the case may require, set out in any technical specification published by or adopted by the Authority from time to time.

47 Windscreen wipers and washers

- (1) A motor vehicle with 3 or more wheels that is fitted with a windscreen must be fitted with at least 1 windscreen wiper unless a driver in a normal driving position can obtain an adequate view of the road ahead of the motor vehicle without looking through the windscreen.
- (2) At least 1 windscreen wiper fitted to the motor vehicle must:
 - (a) be able to remove moisture from the part of the windscreen in front of the driver to allow the driver an adequate view of the road ahead of the motor vehicle when the windscreen is wet, and

- (b) be able to be operated from a normal driving position, and
 - (c) for a motor vehicle built after 1934—continue to operate until the wiper is switched off, and
 - (d) for a motor vehicle built after 1959 the driving position of which is nearer one side of the vehicle than the other:
 - (i) be able to remove moisture from the part of the windscreen in front of the driver, and a corresponding part of the windscreen on the other side of the centre of the motor vehicle, to allow the driver an adequate view of the road ahead of the motor vehicle when the windscreen is wet, and
 - (ii) if the windscreen wipers are operated by engine manifold vacuum—be provided with a vacuum reservoir or pump to maintain the efficient operation of the wiper or wipers while the vehicle is in motion.
- (3) (Repealed)
- (4) The windscreen washer must be able to be operated from a normal driving position.

48 Wheels and tyres—size and capacity

The wheels and tyres fitted to an axle of a vehicle must be of sufficient size and capacity to carry the part of the vehicle's gross mass transmitted to the ground through the axle.

49 Pneumatic tyres generally

A vehicle built after 1932 must be fitted with pneumatic tyres.

50 Pneumatic tyres—carcass construction

- (1) A vehicle with a GVM not over 4.5 tonnes must not have pneumatic tyres of different carcass construction fitted to the same axle, but the tyres may have different cord materials and a different number of plies.
- (2) However, subclause (1) does not apply to a tyre being used in an emergency as a temporary replacement for a tyre complying with the subclause.

51 Pneumatic tyres—size and capacity

The size and capacity of a pneumatic tyre to be fitted to a vehicle must be decided using a cold inflation pressure that is not more than the lesser of:

- (a) the pressure recommended by the tyre manufacturer, and
- (b) a pressure of:
 - (i) for a radial ply tyre—825 kilopascals, or

- (ii) for another tyre—700 kilopascals.

52 Tyres—defects

A tyre fitted to a vehicle must be free of any apparent defect that could make the vehicle unsafe.

53 (Repealed)

54 Tyres—manufacturer's rating

- (1) This clause applies to a motor vehicle if the vehicle:
 - (a) has 4 or more wheels, and
 - (b) was built after 1972, and
 - (c) has a GVM not over 4.5 tonnes.
- (2) However, this clause does not apply to a tyre if the tyre:
 - (a) is recommended by the vehicle builder as suitable for limited use on the vehicle in special circumstances at a speed less than the speed applying to the vehicle under subclause (3), or
 - (b) is being used in an emergency as a temporary replacement for a tyre complying with this clause.
- (3) A tyre fitted to a motor vehicle must, when first manufactured, have been rated by the tyre manufacturer as suitable for road use at the lesser of:
 - (a) a speed of at least:
 - (i) for a car with special features for off-road use—140 kilometres an hour, or
 - (ii) for another car—180 kilometres an hour, or
 - (iii) for another motor vehicle—120 kilometres an hour, and
 - (b) the vehicle's top speed.
- (4) Despite clause 17, this clause applies to a vehicle instead of the tyre speed category requirements in the relevant ADR.

55 Retreads

- (1) A tyre that is retreaded before 29 June 1998 must not be used on a vehicle if:
 - (a) Australian Standard AS 1973-1976 *Retreaded pneumatic passenger car and light truck tyres* or Australian Standard AS 1973-1985 *Retreaded pneumatic passenger car and light truck tyres* applies to the tyre, and

- (b) the tyre was retreaded after publication of the Australian Standard concerned, and
- (c) the tyre was not retreaded in accordance with Australian Standard AS 1973-1976 *Retreaded pneumatic passenger car and light truck tyres*, Australian Standard AS 1973-1985 *Retreaded pneumatic passenger and light truck tyres* or Australian Standard AS 1973-1993 *Pneumatic tyres—Passenger car, light truck and truck/bus—Retreading and repair processes*.

(2) A tyre that is retreaded after 29 June 1998 must not be used on a vehicle if:

- (a) Australian Standard AS 1973-1993 *Pneumatic tyres—Passenger car, light truck and truck/bus—Retreading and repair processes* applies to the tyre, and
- (b) the tyre was not retreaded in accordance with that Australian Standard.

56 Tyre tread

- (1) A tyre on a motor vehicle must not have cleats or other gripping devices that could damage road surfaces.
- (2) Except at tread wear indicators, a tyre fitted to the vehicle must have a tread pattern at least 1.5 millimetres deep in a band that runs continuously:
 - (a) across the tyre width that normally comes into contact with the road, and
 - (b) around the whole circumference of the tyre.
- (3) A vehicle must not be fitted with a tyre that has been treated by recutting or regrooving the tread rubber, unless the tyre was:
 - (a) constructed with an extra thickness of rubber designed for recutting or regrooving, and
 - (b) labelled to indicate the construction.

Division 2 Additional requirements for motor bikes

57 Steering gear and handlebars

- (1) The handlebars on a motor bike must extend at least 250 millimetres, but not over 450 millimetres, on each side of the centre line of the vehicle.
- (2) In taking a measurement for subclause (1), mirrors and lights mounted on the handlebars of the motor bike are disregarded.
- (3) The lowest part of the hand grip on the handle bars must not be higher than 380 millimetres above the attachment point of the handlebars to the motor bike.
- (4) Hand grips on the handle bars must be fitted symmetrically.

- (5) If a motor bike has the head stem as the steering pivot point, the horizontal distance from the midpoint between the head stem bearings to the centre of the front wheel must not be over 550 millimetres.

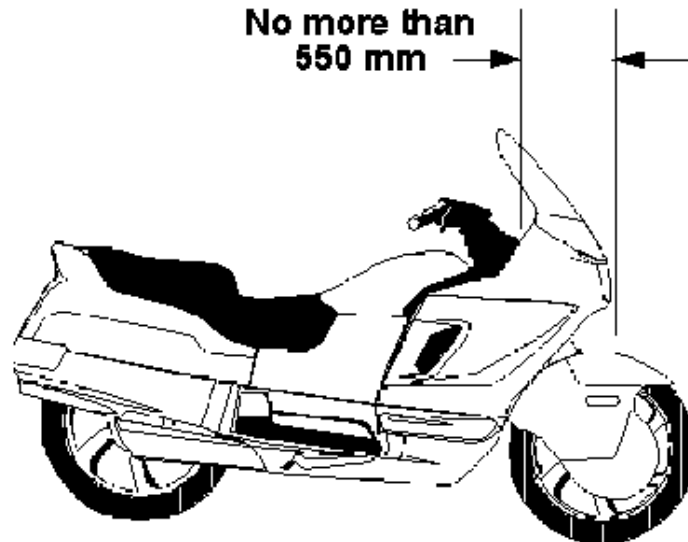

Maximum horizontal distance from midpoint between head stem bearings of motor bike to centre of front wheel

58 Foot rests

A motor bike must be fitted with foot rests for the driver, and for any passenger for whom a seating position is provided.

59 Chain guards

- (1) If the engine power of a motor bike is transmitted to the rear wheel by a chain, the driver and any passenger must be protected from the front sprocket and at least the upper part of the chain by:
- (a) the frame or equipment of the motor bike, or
 - (b) a chain guard.
- (2) A chain guard must cover the chain to a point:
- (a) at least 300 millimetres to the rear of the rearmost foot rest, or
 - (b) above the centre of the rear drive sprocket.

Part 3 Vehicle marking

Note—

This Part contains requirements for a vehicle that help to identify the vehicle and, if the vehicle is unusually long, to warn other motorists.

60 Vehicle and engine identification numbers

(1) In this clause:

number includes a letter of the alphabet.

- (2) A motor vehicle must have an individual engine identification number clearly stamped, embossed or otherwise permanently marked on it.
- (3) A motor vehicle built after 1930 must have the engine identification number on its engine block or the main component of its engine.
- (4) A vehicle must have an individual vehicle identification number clearly stamped, embossed or otherwise permanently marked on a substantial part of its frame or chassis.
- (5) A vehicle or engine identification number must be located where a person can read it easily without having to use tools to remove a part of the vehicle that would otherwise obstruct the person's view.

61 Number-plates

(1) In this clause:

number includes a letter of the alphabet.

vehicle number-plate means a number-plate other than an auxiliary number-plate.

- (2) The vehicle number-plate issued by the Authority for a vehicle must be permanently affixed to the vehicle so that (assuming the vehicle to be on level ground):
- (a) the number-plate is at all times:
- (i) in an upright position that is substantially parallel to the vehicle's axles, and
 - (ii) not more than 1.3 metres above ground level, and
- (b) the number-plate is not obscured, defaced or otherwise not legible, and
- (c) the numbers on the number-plate are clearly visible from a distance of 20 metres at any point within an arc of 45 degrees from the surface of the number-plate above or to either side of the vehicle, as shown in figures 1 and 2 of diagram 1 (in relation to heavy vehicles) and figures 1 and 2 of diagram 2 (in relation to light vehicles), and
- (d) any cover on the number-plate:
- (i) is clear, clean, untinted and flat over its entire surface, and
 - (ii) has no reflective or other characteristics that would prevent the successful

operation of a device approved for use under a law relating to the detection of traffic offences, and

- (e) in the case of a motor vehicle other than a motor bike—one number-plate is affixed to the front of the vehicle and another to its rear, and
- (f) in the case of a motor bike or trailer—at least one number-plate is affixed to its rear, and
- (g) in the case of a motor vehicle for which number-plates of different sizes are issued—the larger of the number-plates is affixed to the rear of the vehicle.

Diagram 1—Heavy vehicles

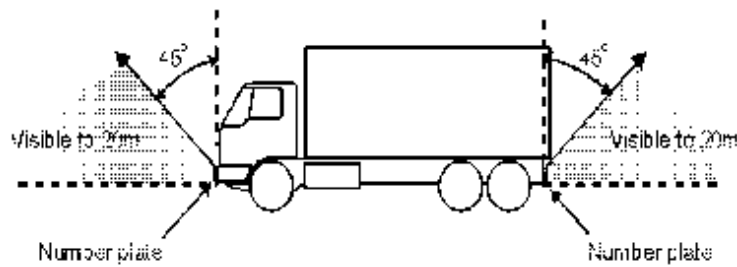

Figure 1

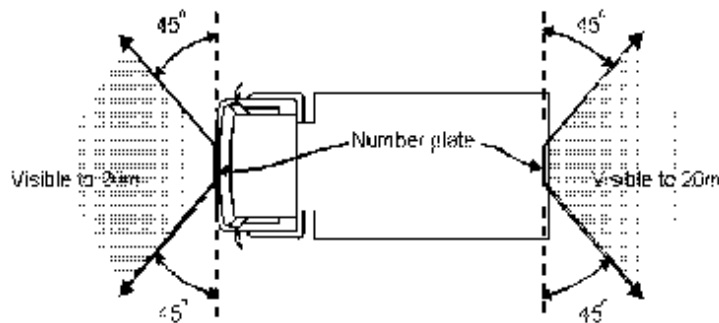

Figure 2

Diagram 2—Light vehicles

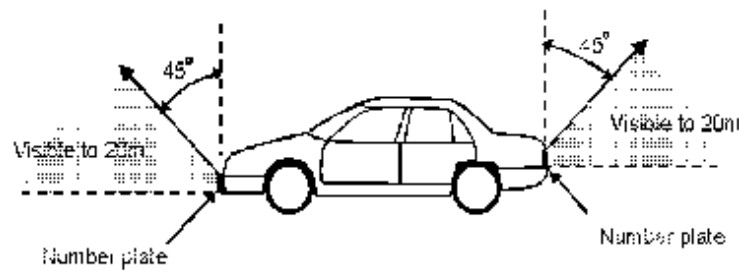

Figure 1

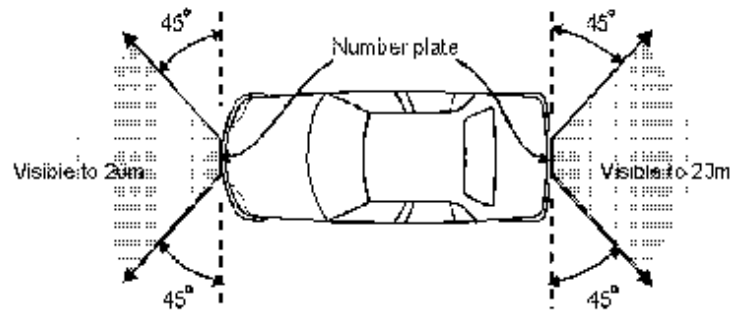

Figure 2

- (3) Subclause (2) (a) does not apply to a vehicle number-plate of a registrable vehicle if:
- (a) due to the construction of the vehicle it is not practicable to comply with that paragraph, and
 - (b) the number-plate is affixed in a manner that complies so far as practicable with that paragraph.
- (4) Subclause (2) (b) does not apply to the rear vehicle number-plate of a registrable vehicle if:
- (a) the rear number-plate of the registrable vehicle is obscured by a vehicle that is being towed by the registrable vehicle, and
 - (b) the towed vehicle displays a rear number-plate in accordance with subclause (2) or, when the towed vehicle is not required to display a rear number-plate, the registration number of the registrable vehicle is displayed at the rear of the towed vehicle in a manner that complies so far as practicable with subclause (2).

62 Compliance plates to be affixed to certain vehicles

Any motor vehicle (other than a tractor or an implement) registered for the first time on or after 1 August 1972 must have securely and prominently affixed within the engine compartment or other position approved by the Authority a plate approved by the Australian Motor Vehicle Certification Board or the Administrator of Vehicle Standards that:

- (a) identifies the specific vehicle, and

- (b) indicates that it meets the standards and procedures administered by the Australian Motor Vehicle Certification Board for that class of vehicle.

63 (Repealed)

64 White or silver band on certain vehicles

- (1) This clause applies to a vehicle that:
 - (a) is at least 2.2 metres wide, and
 - (b) has a body with a vertical measurement under 300 millimetres at the rear, measured from the lowest point of the body above ground level to the highest point, and
 - (c) is not fitted with rear marking plates in accordance with clause 127.
- (2) For subclause (1) (a), the width of a vehicle is measured disregarding any anti-skid device mounted on wheels, central tyre inflation systems, lights, mirrors, reflectors, signalling devices and tyre pressure gauges.
- (3) The vehicle must have a white or silver band at least 75 millimetres high across the full width of the rearmost part of the body of the vehicle.

65-68 (Repealed)

Part 4 Vehicle configuration and dimensions

Note—

This Part sets out various requirements covering the suspension on vehicles and size limits for single vehicles and combinations of vehicles so that they can be operated safely with other traffic, without taking up too much road space or damaging the road and structures on the road.

Generally, the limits in this Part apply to a vehicle and any load it may be carrying.

Specific requirements for loaded vehicles are covered by other laws.

Division 1 Axles

69 Axle configuration

- (1) A motor vehicle must have only:
 - (a) 1 axle group, or single axle, towards the front of the vehicle, and
 - (b) 1 axle group, or single axle, towards the rear of the vehicle.
- (2) (Repealed)
- (3) A trailer must have only:
 - (a) 1 axle group or single axle, or

- (b) 2 axle groups, 2 single axles, or 1 axle group and single axle, in the following configuration:
 - (i) 1 axle group, or single axle, towards the front of the vehicle, with all the wheels on the axle group or single axle connected to the steering mechanism for that part of the trailer,
 - (ii) 1 axle group, or single axle, towards the rear of the vehicle.
- (4) A semi-trailer that is extendible, or is fitted with sliding axles, must:
 - (a) have a securing device that:
 - (i) can securely fix the extendible part or sliding axles to the rest of the vehicle in any position of adjustment provided, and
 - (ii) is located in a position that can prevent accidental or inadvertent release, if the device is mounted on the chassis of the vehicle, and
 - (iii) is fitted with a visible or audible warning system to indicate to a person standing beside the vehicle that the device is not engaged, and
 - (iv) is fitted with a way of preventing loss of air from the air brake supply, if the device uses air from the brake system and fails in a way allowing air to escape, and
 - (v) is held in the applied position by direct mechanical action without the intervention of an electric, hydraulic or pneumatic device, and
 - (b) be built so the adjustable parts of the vehicle remain connected if the securing device fails.

70 (Repealed)

Division 2 Dimensions

71 Width

- (1) A vehicle must not be over 2.5 metres wide.
- (2) For subclause (1), the width of a vehicle is measured without taking into account any anti-skid device mounted on wheels, central tyre inflation systems, lights, mirrors, reflectors, signalling devices and tyre pressure gauges.

72 Length of single motor vehicles

- (1) A motor vehicle must not be over 12.5 metres long.
- (2) A controlled access bus must not be over 14.5 metres long.

- (3) An articulated bus must not be over 18 metres long.

73 Length of single trailers

- (1) On a semi-trailer or a dog trailer:
- (a) the distance between the point of articulation at the front of the trailer and the rear overhang line must not be over 9.5 metres, and
 - (b) the distance between the point of articulation at the front of the trailer and the rear of the trailer must not be over 12.3 metres.
- (2) A projection forward of the point of articulation at the front of a semi-trailer must be contained within a radius of 1.9 metres from the point of articulation.

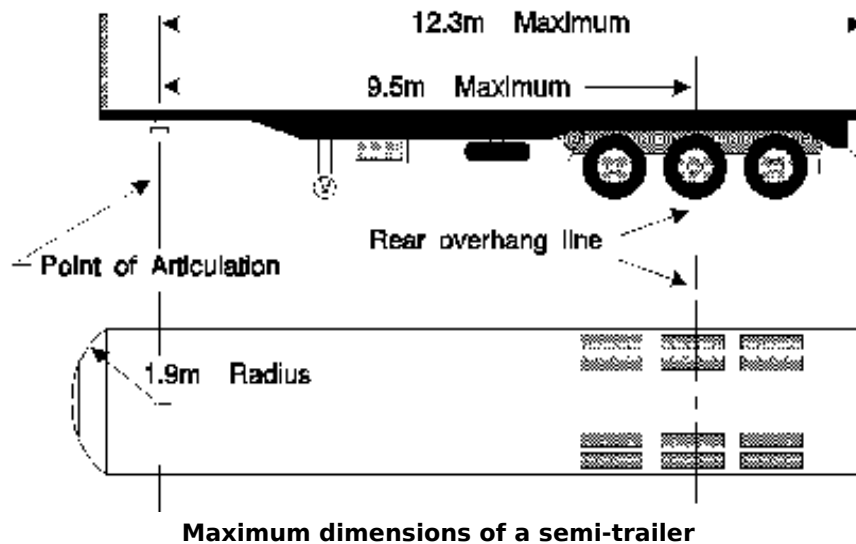

- (3) If a semi-trailer has 2 or more points of articulation at the front of the trailer, it must comply with subclauses (1) and (2) when measured at one of the points.
- (4) A trailer built to carry cattle, sheep, pigs or horses on 2 or more partly or completely overlapping decks must not have over 12.5 metres of its length available for the carriage of animals.
- (5) For subclause (4), the length available for the carriage of animals on a trailer is measured from the inside of the front wall or door of the trailer to the inside of the rear wall or door of the trailer, with any intervening partitions disregarded.

74 Length of combinations

- (1) A combination must not be over:
- (a) for a B-double—25 metres long, and
 - (b) for a road train—53.5 metres long, and

- (c) for a combination, except a road train, designed to carry vehicles on 2 or more partly or completely overlapping decks—25 metres long, and
 - (d) for another combination—19 metres long.
- (2) In a B-double built to carry cattle, sheep, pigs or horses, the 2 semi-trailers must not have over 18.8 metres of their combined length available for the carriage of animals.
- (3) For subclause (2), the length available for the carriage of animals on a trailer is measured from the inside of the front wall or door of the trailer to the inside of the rear wall or door of the trailer, with any intervening partitions disregarded.

75 Rear overhang

- (1) The rear overhang of a semi-trailer, or dog trailer consisting of a semi-trailer and converter dolly, must not exceed the lesser of:
- (a) 60% of the distance between the point of articulation at the front and the rear overhang line, and
 - (b) 3.7 metres.
- (2) A semi-trailer with 2 or more points of articulation at the front must comply with subclause (1) when measured at the same point used for measurement for compliance with clause 73 (3).
- (3) The rear overhang of a trailer with only 1 axle group or single axle (except a semi-trailer) must not exceed the lesser of:
- (a) the length of the load carrying area, or body, ahead of the rear overhang line, and
 - (b) 3.7 metres.
- (4) The rear overhang of a vehicle not mentioned in subclause (1) or (3) must not exceed the lesser of:
- (a) 60% of the distance between the centre of the front axle and the rear overhang line, and
 - (b) 3.7 metres.

76 Trailer drawbar length

- (1) The distance between the coupling pivot point on the drawbar of a dog trailer, and the centre line of the front axle group or of the front single axle of the trailer, must:
- (a) not be over 5 metres, and
 - (b) not be under 3 metres, if the trailer is used in a road train over 19 metres long.

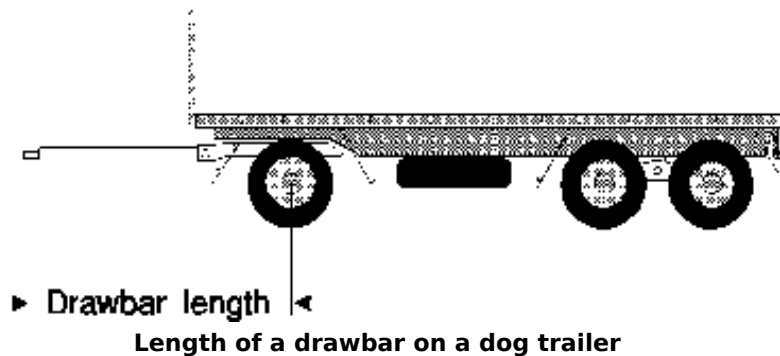

- (2) The distance between the coupling pivot point on a drawbar, and the centre line of the axle group or single axle on a trailer with only 1 axle group or single axle (except a semi-trailer) must not be over 8.5 metres.

77 Height

- (1) A vehicle must not be over 4.3 metres high.
- (2) (Repealed)

78 Ground clearance

- (1) In this clause:

ground clearance, of a vehicle, means the minimum distance to the ground from a point on the underside of the vehicle, except a point on a tyre, wheel, wheel hub, brake backing plate or flexible mudguard or mudflap of the vehicle.

- (2) A motor vehicle or combination must have a ground clearance of:
- (a) at least 100 millimetres at any point within 1 metre of an axle, and
 - (b) at least one-thirtieth of the distance between the centres of adjacent axles at the midpoint between them, and
 - (c) at any other point—at least the distance that allows the vehicle or combination to pass over a peak in the road with a gradient on either side of 1:15, if the wheels of 1 axle of the vehicle or combination are on the slope on one side of the peak and the wheels of the next axle are on the slope on the other side.
- (3) However, subclause (2) does not apply to:
- (a) a motor vehicle with less than 4 wheels, or
 - (b) a combination that includes a motor vehicle with less than 4 wheels.

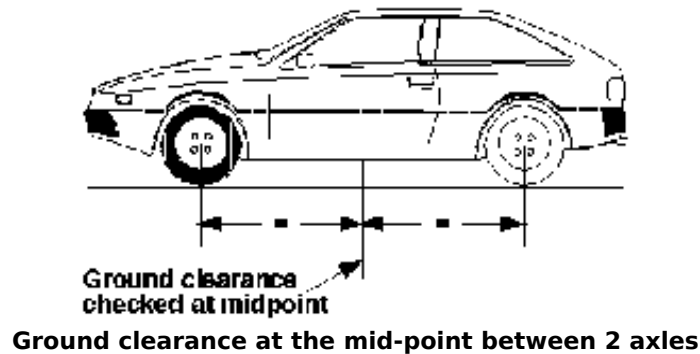

Division 3

79-81 (Repealed)

Part 5 Lights and reflectors

Note—

This Part deals with how the lights on a vehicle must be fitted and work so that the driver can see the road, pedestrians and other vehicles at night, and can signal to others.

Other laws provide for when certain lights must be switched on.

In this Part, the description “yellow” is used as a more modern term, instead of the description “amber” which is used in earlier legislation and some ADRs.

Division 1 General requirements for lights

82 Lighting devices that can be attached to vehicles

A device capable of projecting light must not be attached to any vehicle unless it is a device required or permitted to be attached to the vehicle by this Schedule.

83 Certain requirements apply only at night

The requirements of this Part for a light, except a brake or direction indicator light, to be visible over a stated distance apply only at night.

84 Prevention of glare

A light, except a high-beam headlight, fitted to a vehicle must be built and adjusted to provide the necessary amount of light without dazzling the driver of another vehicle approaching, or being approached by, the vehicle.

85 Pairs of lights

- (1) If lights are required under this Schedule to be fitted to a vehicle in pairs:
 - (a) a light must be fitted on each side of the longitudinal axis of the vehicle, and
 - (b) the centre of each light in a pair must be the same distance from the longitudinal

axis of the vehicle, and

(c) the centre of each light in a pair must be at the same height above ground level, and

(d) each light in a pair must project approximately the same amount of light of the same colour.

(2) Subclause (1) applies to a motor bike with an attached sidecar as if the sidecar were not attached.

Division 2 Headlights

86 Headlights to be fitted to vehicles

(1) A motor vehicle must be fitted with:

(a) 1 low-beam headlight if it is a moped, motor bike, or motor trike with 1 front wheel, or

(b) a pair of low-beam headlights if it has 4 or more wheels or is a motor trike, except a moped, with 2 front wheels.

(2) If a motor vehicle built after 1934 can travel at over 60 kilometres an hour:

(a) each low-beam headlight mentioned in subclause (1) must be able to work in the high-beam position, or

(b) the vehicle must be fitted with:

(i) 1 headlight that can work in the high-beam position if the vehicle is required to have 1 low-beam headlight, or

(ii) a pair of headlights that can work in the high-beam position.

(3) A motor bike may be equipped with a headlight modulation system that:

(a) varies the brightness of its high-beam headlight or low-beam headlight, but not both, at a rate of at least 200 and at most 280 flashes a minute, and

(b) is designed to operate only in daylight.

(4) Additional headlights may be fitted to a motor bike or motor trike, or a motor vehicle with 4 or more wheels that was built before 1970.

(5) Additional pairs of headlights may be fitted to a motor vehicle with 4 or more wheels that was built after 1969.

(6) Despite clause 17 and any requirement of the third edition ADR, an emergency services vehicle may be fitted with headlights or additional headlights that are

capable of flashing if:

- (a) the headlights flash only when on low beam, and
- (b) the headlights are wired to operate in conjunction with any flashing or rotating lights fitted to the vehicle as permitted by clause 124 (4).

(7) In this clause, an **emergency services vehicle** means any of the following:

- (a) a police vehicle,
- (b) an ambulance,
- (c) a firefighting vehicle,
- (d) a Red Cross vehicle used for conveyance of blood for urgent transfusions,
- (e) a mines rescue or other rescue vehicle,
- (f) another vehicle that is an emergency vehicle within the meaning of the [Road Rules 2014](#).

87 How headlights are to be fitted

- (1) The centres of low-beam headlights fitted as a pair on a motor vehicle with 4 or more wheels must be at least 600 millimetres apart.
- (2) However, subclause (1) does not apply to a motor vehicle built before 1970 if the centres of its low-beam headlights:
 - (a) were under 600 millimetres apart when the vehicle was built, and
 - (b) are not nearer than they were when the vehicle was built.
- (3) Each low-beam headlight of a pair on a motor trike (except a moped) with 2 front wheels must not be over 400 millimetres from the nearer side of the vehicle.
- (4) The centre of a low-beam headlight fitted to a motor vehicle built after June 1953 must be:
 - (a) at least 500 millimetres above ground level, and
 - (b) not over 1.4 metres above ground level.

88 How single headlights are to be fitted

- (1) A motor bike or trike with a single headlight fitted must have the light fitted in the centre.
- (2) Subclause (1) applies to a motor bike with an attached sidecar as if the sidecar were not attached.

89 How additional headlights are to be fitted

If 2 or more additional headlights are fitted to a motor vehicle with 4 or more wheels, the additional headlights must as far as possible be fitted in pairs.

90 Performance of headlights

- (1) When on, a headlight, or additional headlight, fitted to a vehicle must:
 - (a) show only white light, and
 - (b) project its main beam of light ahead of the vehicle.
- (2) Headlights must be fitted to a vehicle so their light does not reflect off the vehicle into the driver's eyes.

91 Effective range of headlights

- (1) This clause applies to a headlight that is on at night.
- (2) A low-beam headlight must illuminate the road ahead of the vehicle for at least 25 metres.
- (3) A high-beam headlight must illuminate the road ahead of the vehicle for at least 50 metres.
- (4) However, a low-beam headlight fitted to a motor vehicle built before 1931, or a moped, need only illuminate the road ahead of the vehicle for 12 metres.

92 Changing headlights from high-beam to low-beam position

- (1) A motor vehicle built after 1934 that can travel at over 60 kilometres an hour must be fitted with:
 - (a) a dipping device enabling the driver in the normal driving position:
 - (i) to change the headlights from the high-beam position to the low-beam position, or
 - (ii) simultaneously to switch off a high-beam headlight and switch on a low-beam headlight, and
 - (b) for a vehicle built after June 1953—a device to indicate to the driver that the headlights are in the high-beam position.
- (2) A headlight fitted to a vehicle not fitted with a dipping device mentioned in subclause (1) (a) must operate in the low-beam position.
- (3) When a headlight fitted to a vehicle is switched to the low-beam position, any other headlight on the vehicle must operate only in the low-beam position or be off.

Division 3 Parking lights

93 Parking lights

- (1) A motor vehicle built after June 1953 must be fitted with:
 - (a) a pair of parking lights if it is a motor trike with 2 front wheels (except a moped) or a motor vehicle with 4 or more wheels, or
 - (b) at least 1 parking light if it is a motor bike with an attached sidecar, or a motor trike with 1 front wheel (except a moped).
- (2) A pair of parking lights fitted to a motor vehicle with 4 or more wheels must be fitted with the centre of each light:
 - (a) at least 600 millimetres from the centre of the other light, and
 - (b) not over 510 millimetres from the nearer side of the vehicle.
- (3) However, a pair of parking lights fitted to a motor vehicle under 1300 millimetres wide may be fitted with the centre of each light not under 400 millimetres from the centre of the other light.
- (4) A parking light fitted to a motor trike with 2 front wheels must not be over 400 millimetres from the nearer side of the vehicle.
- (5) A parking light fitted to a motor bike with a sidecar must be fitted not over 150 millimetres from the side of the sidecar furthest from the motor bike.

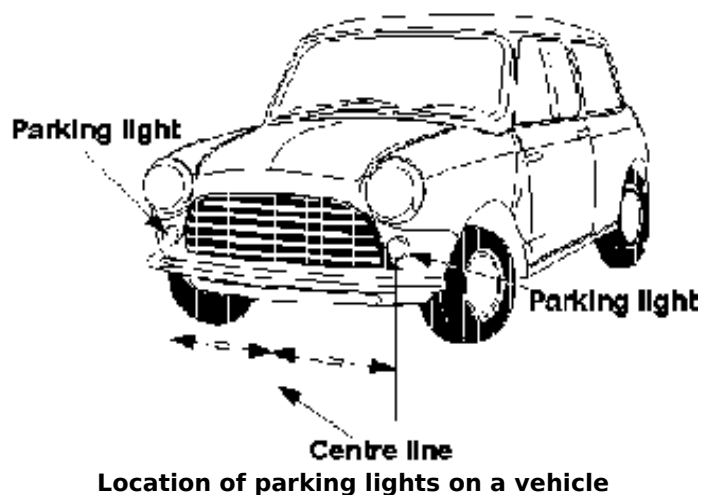

- (6) When on, a parking light must:
 - (a) show a white or yellow light visible 200 metres from the front of the vehicle, and
 - (b) not use over 7 watts power.

- (7) A parking light fitted to a motor vehicle built after 1969 must be wired so the parking light is on when a headlight on the vehicle is on.
- (8) A parking light fitted to a sidecar attached to a motor bike must be wired to operate when a headlight, tail light or parking light on the motor bike is on.
- (9) For subclause (3), the width of a vehicle is measured disregarding any anti-skid device mounted on wheels, central tyre inflation systems, lights, mirrors, reflectors, signalling devices and tyre pressure gauges.

Division 4 Daytime running lights

94 Daytime running lights

- (1) A pair of daytime running lights may be fitted to a motor vehicle.
- (2) A pair of daytime running lights fitted to a vehicle with 4 or more wheels must be fitted with the centre of each light:
 - (a) at least 600 millimetres from the centre of the other light, and
 - (b) not over 510 millimetres from the nearer side of the vehicle.
- (3) However, a pair of daytime running lights fitted to a motor vehicle under 1300 millimetres wide may be fitted with the centre of each light not under 400 millimetres from the centre of the other light.

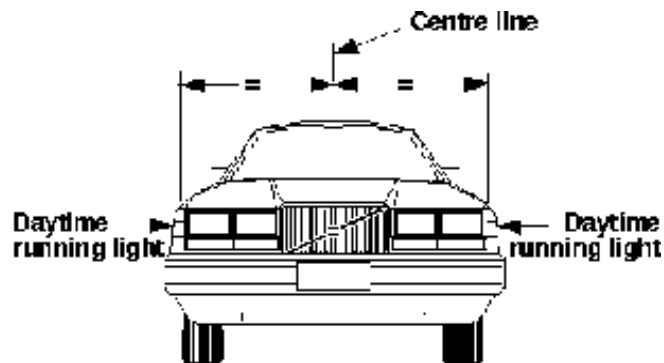

Location of daytime running lights on a vehicle

- (4) When on, a daytime running light must:
 - (a) show a white or yellow light visible from the front of the vehicle, and
 - (b) not use over 25 watts power.

Note—

The third edition ADRs only allow white daytime running lights.

- (5) Daytime running lights must be wired so they are off when a headlight, except a

headlight being used as a flashing signal, is on.

- (6) For subclause (3), the width of a vehicle is measured disregarding any anti-skid device mounted on wheels, central tyre inflation systems, lights, mirrors, reflectors, signalling devices and tyre pressure gauges.

Division 5 Tail lights

95 Tail lights generally

- (1) A vehicle must have at least 1 tail light fitted on or towards the rear of the vehicle.
- (2) A motor trike with 2 rear wheels, or a motor vehicle with 4 or more wheels, built after 1959 must have at least 1 tail light fitted on or towards each side of the rear of the vehicle.
- (3) A trailer built after June 1973 must have at least 1 tail light fitted on or towards each side of the rear of the vehicle.
- (4) The centre of a tail light mentioned in subclause (1), (2) or (3) must not be over:
 - (a) 1.5 metres above ground level, or
 - (b) if it is not practicable to fit the light lower—2.1 metres above ground level.
- (5) A vehicle may have 1 or more additional tail lights at any height above ground level.

96 Pattern of fitting tail lights

- (1) If only 1 tail light is fitted to a vehicle, it must be fitted in the centre or to the right of the centre of the vehicle's rear.
- (2) Subclause (1) applies to a motor bike with an attached sidecar as if the sidecar were not attached.
- (3) If 2 or more tail lights are fitted to a vehicle, at least 2 must be fitted as a pair.
- (4) Tail lights fitted in accordance with this Division may also serve as rear clearance lights if they are fitted to a vehicle in accordance with clause 102 (3).

97 Performance of tail lights

- (1) When on, a tail light of a vehicle must:
 - (a) show a red light visible 200 metres from the rear of the vehicle, and
 - (b) not use over 7 watts power.
- (2) A tail light fitted to a street rod vehicle may incorporate a blue lens not over 20 millimetres in diameter.

98 Wiring of tail lights

A tail light of a motor vehicle must be wired to come on, and stay on, when a parking light or headlight on the vehicle is on, unless an external switch is fitted to operate the tail light.

Division 6 Number-plate lights

99 Number-plate lights

- (1) At least 1 number-plate light must be fitted to the rear of a vehicle.
- (2) When on, the number-plate light or lights must illuminate a number-plate on the rear of the vehicle (other than an auxiliary number-plate) with white light, so the characters on the number-plate can be read at night 20 metres from the rear of the vehicle.
- (3) A number-plate light:
 - (a) may be combined with another light, and
 - (b) must not project white light to the rear of the vehicle except by reflection, and
 - (c) must not obscure the characters on the number-plate, and
 - (d) must be wired to come on, and stay on, when a parking light, headlight or tail light on the vehicle is on.

Division 7 Clearance lights

100 Front clearance lights

- (1) Front clearance lights may only be fitted to a vehicle that is at least 1.8 metres wide.
- (2) A pair of front clearance lights must be fitted to a motor vehicle that is at least 2.2 metres wide, or a prime mover.
- (3) The centre of a front clearance light must be:
 - (a) not over 400 millimetres from the nearer side of the vehicle, and
 - (b) if the vehicle was built after June 1953:
 - (i) at least 750 millimetres higher than the centre of any low-beam headlight fitted to the vehicle, or
 - (ii) not lower than the top of the windscreen.
- (4) However, a front clearance light may be mounted on an external rear vision mirror or a mirror support if, when the mirror is correctly adjusted, no part of the lens of the

clearance light is visible to a person in the normal driving position.

- (5) When on, a front clearance light must:
 - (a) show a yellow or white light visible 200 metres from the front of the vehicle, and
 - (b) not use over 7 watts power.

101 External cabin lights

- (1) A motor vehicle fitted with front clearance lights may also have additional forward-facing lights on or above the roof of its cabin.
- (2) The additional forward-facing lights must be spaced evenly between the front clearance lights, with their centres at least 120 millimetres apart.
- (3) When on, an additional forward-facing light must:
 - (a) show a yellow or white light, and
 - (b) not use over 7 watts power.

102 Rear clearance lights

- (1) Rear clearance lights may only be fitted to a vehicle that is at least 1.8 metres wide.
- (2) A pair of rear clearance lights must be fitted to the rear of a vehicle that is at least 2.2 metres wide.
- (3) The centre of a rear clearance light must be:
 - (a) not over 400 millimetres from the nearer side of the vehicle, and
 - (b) if practicable, at least 600 millimetres above ground level.
- (4) When on, a rear clearance light must:
 - (a) show a red light visible 200 metres from the rear of the vehicle, and
 - (b) not use over 7 watts power.

Division 8 Side marker lights

103 Vehicles needing side marker lights

- (1) A pair of side marker lights must be fitted towards the rear of the sides of a motor vehicle that is over 7.5 metres long and at least 2.2 metres wide.
- (2) A pole-type trailer, and a motor vehicle built to tow a pole-type trailer, with at least 1 cross-bar or bolster must have a side marker light fitted to each side of the back or only cross-bar or bolster.

- (3) A pole-type trailer with 2 or more cross-bars or bolsters may also have a side marker light fitted to each side of the front cross-bar or bolster.
- (4) At least 2 side marker lights must be fitted to each side of:
 - (a) a trailer, except a pole-type trailer, that is at least 2.2 metres wide and not over 7.5 metres long, and
 - (b) a semi-trailer that is not over 7.5 metres long.
- (5) At least 3 side marker lights must be fitted to each side of:
 - (a) a trailer, except a pole-type trailer, that is at least 2.2 metres wide and over 7.5 metres long, and
 - (b) a semi-trailer that is over 7.5 metres long.
- (6) For subclauses (1), (4) and (5), the width of a vehicle is measured disregarding any anti-skid device mounted on wheels, central tyre inflation systems, lights, mirrors, reflectors, signalling devices and tyre pressure gauges.

104 Location of side marker lights

- (1) The centre of a side marker light must not be over 150 millimetres from the nearer side of the vehicle.
- (2) A front side marker light fitted to a motor vehicle must be towards the front of the side of the vehicle with no part of the lens visible to the driver.
- (3) The centre of a front side marker light fitted to a trailer must be:
 - (a) within 300 millimetres of the front of the side of the trailer, or
 - (b) if the construction of the trailer makes it impracticable to comply with paragraph (a)—as near as practicable to the front of the trailer.
- (4) The centre of a rear side marker light fitted to a vehicle must be:
 - (a) within 300 millimetres of the rear of the side of the vehicle, or
 - (b) if the construction of the vehicle makes it impracticable to comply with paragraph (a)—as near as practicable to the rear of the vehicle.
- (5) Side marker lights fitted to a vehicle must, as far as practicable, be evenly spaced along the side of the vehicle.
- (6) Subclauses (2)–(5) do not apply to side marker lights fitted to a cross-bar or bolster of a pole-type trailer.
- (7) Only the side marker lights nearest to the rear need be fitted if complying with

subclauses (3) and (4) would result in the front and rear side marker lights being under 2.5 metres apart.

- (8) A side marker light fitted to a vehicle must be fitted so that:
- (a) its centre is not over:
 - (i) 1.5 metres above ground level, or
 - (ii) if it is not practicable to fit it lower—2.1 metres above ground level, and
 - (b) its centre is at least 600 millimetres above ground level, and
 - (c) it is, as far as practicable, in a row of side marker lights along the side of the vehicle.
- (9) Subclause (8) (a) does not apply to a side marker light that is not required to be fitted to the vehicle by clause 103.

105 Performance of side marker lights

- (1) When on, a side marker light fitted to a vehicle must:
- (a) show a light visible 200 metres from the vehicle, and
 - (b) not use over 7 watts power.
- (2) When on, a side marker light fitted to a vehicle must show:
- (a) to the front of the vehicle—a yellow light, and
 - (b) to the rear of the vehicle:
 - (i) if the light also operates as a rear light or reflector—a red light, and
 - (ii) in any other case—a red or yellow light.
- (3) However, if a pole-type trailer with 2 or more cross-bars or bolsters has the side marker lights permitted by clause 103 (3):
- (a) the side marker lights fitted to the front cross-bar or bolster may comply with subclause (2) (a) only, and
 - (b) the side marker lights fitted to the back cross-bar or bolster may comply with subclause (2) (b) only.

106 Side marker lights and rear clearance lights

The side marker light nearest to the rear of a vehicle may also be a rear clearance light for the purposes of clause 102.

Division 9 Brake lights

107 Fitting brake lights

- (1) A brake light must be fitted to the rear of a vehicle built after 1934.
- (2) A pair of brake lights must be fitted to the rear of:
 - (a) a motor vehicle built after 1 October 1991 that has 4 or more wheels, and
 - (b) a motor trike built after 1 October 1991 that has 2 rear wheels, and
 - (c) a trailer built after June 1973.
- (3) The centre of a brake light must be:
 - (a) at least 350 millimetres above ground level, and
 - (b) not over:
 - (i) 1.5 metres above ground level, or
 - (ii) if it is not practicable to fit the light lower—2.1 metres above ground level.
- (4) A vehicle may be fitted with 1 or more additional brake lights.
- (5) The centre of an additional brake light must be at least 350 millimetres above ground level.
- (6) If only 1 brake light is fitted to a vehicle, it must be fitted in the centre or to the right of the centre of the vehicle's rear.
- (7) Subclause (6) applies to a motor bike with an attached sidecar as if the sidecar were not attached.

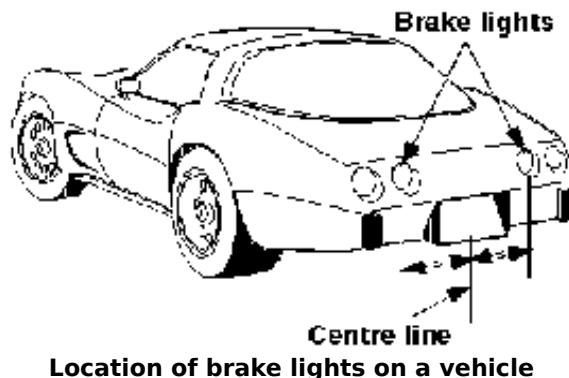

108 Performance and operation of brake lights

- (1) When on, a brake light must show a red light visible 30 metres from the rear of the vehicle.

- (2) A brake light fitted to a street rod vehicle may incorporate a blue lens not over 20 millimetres in diameter.
- (3) A brake light fitted to a motor vehicle must come on, if it is not already on, when:
 - (a) for a vehicle with 4 or more wheels or built after 1974—a service brake is applied, or
 - (b) for another vehicle—the rear wheel brake is applied.
- (4) Subclause (3) does not apply if the controls in the vehicle that start the engine are in a position that makes it impossible for the engine to operate.
- (5) A brake light on a trailer must come on when:
 - (a) the brake light of the towing vehicle comes on, or
 - (b) a brake control on the towing vehicle, which independently activates the service brake on the trailer, is operated.
- (6) A brake light may be operated by an engine brake, retarder or similar device if the device does not interfere with the proper operation of the brake light.

Division 10 Reversing lights

109 Reversing lights

- (1) One or more reversing lights may be fitted to the rear of a vehicle and on each side towards the rear of the vehicle.
- (2) A reversing light must have its centre not over 1.2 metres above ground level.
- (3) When on, a reversing light must show a white or yellow light to the rear or to the side and rear of the vehicle.

Note—

Third edition ADRs only allow white reversing lights.

- (4) A reversing light fitted to a motor vehicle must be wired so it operates only when the vehicle is reversing or in reverse gear.
- (5) A reversing light fitted to a trailer must be wired so it operates only when a motor vehicle towing the trailer is reversing or in reverse gear.
- (6) A yellow reversing light may also operate as a direction indicator light.

Division 11 Direction indicator lights

110 Direction indicator lights on motor vehicles

- (1) A motor vehicle with 4 or more wheels that was built after August 1966 must have:
 - (a) a pair of direction indicator lights fitted on, or towards, its front that face forwards, and
 - (b) a pair of direction indicator lights fitted on, or towards, its rear that face backwards.
- (2) A motor vehicle with less than 4 wheels that was built after June 1975 must have:
 - (a) a pair of direction indicator lights fitted on, or towards, its front that face forwards, and
 - (b) a pair of direction indicator lights fitted on, or towards, its rear that face backwards.
- (3) A motor vehicle that is not required to have direction indicator lights may have:
 - (a) 1 or more pairs of direction indicator lights that are visible from both the front and rear of the vehicle, or
 - (b) both:
 - (i) a pair of direction indicator lights fitted on, or towards, its front that face forwards, and
 - (ii) a pair of direction indicator lights fitted on, or towards, its rear that face backwards.

111 Direction indicator lights on trailers

- (1) A trailer built after June 1973 must have a pair of direction indicator lights fitted on, or towards, its rear that face backwards.
- (2) A trailer that is not required to have direction indicator lights may have 1 or more pairs of direction indicator lights fitted on, or towards, its rear that face backwards.

112 Location of direction indicator lights

- (1) A pair of direction indicator lights fitted to a vehicle must be spaced as follows:
 - (a) lights fitted to the front of a motor bike or the single wheel end of a motor trike must be spaced in accordance with the requirements for the position of front indicators set out in paragraph 6.3.3.1 of Appendix A to third edition ADR 19/02,
 - (b) lights fitted at the rear of a motor bike must be spaced in accordance with the

requirements for the position of rear indicators set out in paragraph 6.3.3.1 of Appendix A to third edition ADR 19/02,

- (c) lights fitted at the 2 wheel end of a motor trike must be spaced so that the centre of each light is at least 600 millimetres from the centre of the other light, unless the centre of each direction indicator light is not over 400 millimetres from the nearer side of the vehicle,
 - (d) lights fitted to another vehicle with a width of not over 1300 millimetres must be spaced so that the centre of each light is at least 400 millimetres from the centre of the other light,
 - (e) lights fitted to another vehicle with a width of over 1300 millimetres must be spaced so that the centre of each light is at least 600 millimetres from the centre of the other light.
- (1A) Subclauses (1) (a) and (b) apply to a vehicle even if it was built before the date stated in the ADR for vehicles of that type.
- (2) The centre of each direction indicator light must be at least 350 millimetres above ground level.
- (3) The centre of each light in a pair of direction indicator lights required to be fitted to a vehicle must not be over:
- (a) 1.5 metres above ground level, or
 - (b) if it is not practicable for the light to be fitted lower—2.1 metres above ground level.
- (4) For subclause (1), the width of a vehicle is measured disregarding any anti-skid device mounted on wheels, central tyre inflation systems, lights, mirrors, reflectors, signalling devices and tyre pressure gauges.

113 Operation and visibility of direction indicator lights

- (1) A direction indicator light fitted to a motor vehicle must:
- (a) when operating, display regular flashes of light at a rate of not over 120 flashes a minute, and:
 - (i) for a motor vehicle with 4 or more wheels—at least 60 flashes a minute, or
 - (ii) for any other motor vehicle—at least 45 flashes a minute, and
 - (b) be able to be operated by a person in the normal driving position, and
 - (c) be wired to an audible or visible device in the vehicle that tells the driver that the direction indicator light is operating, and

- (d) flash at the same time and rate as any other direction indicator lights fitted on the same side of the vehicle.
- (2) A direction indicator light fitted to a side of a trailer must, when operating, flash at the same time and rate as the direction indicator light or lights fitted to the same side of the motor vehicle towing the trailer.
- (3) The flashes of light displayed by a direction indicator light must be:
 - (a) if the light faces forward—white or yellow, and
 - (b) if the light faces backwards:
 - (i) yellow, or
 - (ii) for a vehicle built before July 1973—yellow or red, and
 - (c) if the light faces out from the side of the vehicle:
 - (i) white or yellow towards the front and side, and
 - (ii) for a vehicle built before July 1973—yellow or red towards the rear and side, and
 - (iii) for a vehicle built after June 1973—yellow towards the rear and side.

Note—

The ADRs only allow yellow direction indicator lights.

- (4) If a motor vehicle's direction indicator lights display only yellow light, the vehicle may be equipped to allow the lights to operate simultaneously on both sides of the vehicle, if a visible or audible signal tells the driver when the lights are operating simultaneously.
- (5) When on, a direction indicator light must be visible 30 metres from:
 - (a) if the light faces forwards—the front of the vehicle, or
 - (b) if the light faces backwards—the rear of the vehicle, or
 - (c) if the light faces out from the side of the vehicle—that side of the vehicle.
- (6) When on, each direction indicator light in at least 1 pair of lights fitted on or towards the front of a prime mover, or a motor vehicle over 7.5 metres long, must be visible at a point:
 - (a) 1.5 metres at right angles from the side of the vehicle where the light is fitted, and
 - (b) in line with the rear of the vehicle.

Division 12 Fog lights

114 Front fog lights

- (1) A pair of front fog lights may be fitted to a motor vehicle with 4 or more wheels.
- (2) A pair of front fog lights, or a single front fog light, may be fitted to a motor bike or trike.
- (3) A pair of front fog lights fitted to a motor vehicle with 4 or more wheels must have the centre of each light not over 400 millimetres from the nearer side of the vehicle unless the centres of the lights are at least 600 millimetres apart.
- (4) If the top of the front fog light is higher than the top of any low-beam headlight on the vehicle, the centre of the fog light must not be higher than the centre of the low-beam headlight.
- (5) A front fog light must:
 - (a) when on:
 - (i) project white or yellow light in front of the vehicle, and
 - (ii) be a low-beam light, and
 - (b) be able to be operated independently of any headlight, and
 - (c) be fitted so the light from it does not reflect off the vehicle into the driver's eyes.

115 Rear fog lights

- (1) A vehicle may have fitted to its rear:
 - (a) a pair of rear fog lights, or
 - (b) 1 rear fog light fitted on, or to the right, of the centre of the vehicle.
- (2) Subclause (1) (b) applies to a motor bike with an attached sidecar as if the sidecar were not attached.
- (3) A rear fog light must:
 - (a) have its centre:
 - (i) not over 1.5 metres above ground level, and
 - (ii) at least 100 millimetres from the centre of a brake light, and
 - (b) when on, project red light behind the vehicle, and
 - (c) not use over 27 watts power, and

- (d) be wired to a visible device in the vehicle that tells the driver that the rear fog light is operating.

Division 13 Interior lights

116 Interior lights

A vehicle may be fitted with interior lights that illuminate any interior part of the vehicle.

Division 14 Reflectors generally

117 General requirements for reflectors

- (1) A reflector fitted to a vehicle must show a red, yellow or white reflection of light when light is projected directly onto the reflector at night by a low-beam headlight that:
 - (a) is 45 metres from the reflector, and
 - (b) complies with this Schedule.
- (2) The reflection must be clearly visible from the position of the headlight.
- (3) A reflector may be in the form of reflecting sheeting or tape or other efficient reflecting material.

Division 15 Rear reflectors

118 Rear reflectors

- (1) A motor vehicle with 4 or more wheels, and a trailer, must have a rear-facing red reflector towards each side of its rear.
- (2) A motor bike, a sidecar attached to a motor bike, and a motor trike, must have a rear-facing red reflector.
- (3) The centre of each reflector must be:
 - (a) at the same height above ground level, and
 - (b) not over 1.5 metres above ground level.
- (4) However, subclause (3) does not apply to a reflector fitted to a sidecar attached to a motor bike.
- (5) A reflector fitted to a motor vehicle with 4 or more wheels, or a trailer, must not be over 400 millimetres from the nearer side of the vehicle.
- (6) A vehicle fitted with rear-facing red reflectors in accordance with subclause (1) or (2) may be fitted with additional red reflectors at any height above ground level or at any distance from the side of the vehicle.

Division 16 Side reflectors

119 Compulsory side reflectors on pole-type trailers

- (1) Yellow or red side-facing reflectors must be fitted to the pole of a pole-type trailer so:
 - (a) 1 reflector is fitted to the middle third of the left and right faces of the pole, and
 - (b) the front reflector is not over 3 metres from the front of the trailer, and
 - (c) the other reflectors are not over 3 metres apart.
- (2) Additional side-facing reflectors may be fitted to a pole-type trailer in accordance with clause 120.

120 Optional side reflectors

- (1) A vehicle may be fitted with side-facing reflectors.
- (2) A side-facing reflector:
 - (a) towards the front of the vehicle must be yellow or white, and
 - (b) towards the rear of the vehicle must be yellow or red, and
 - (c) on the central part of the vehicle must be yellow.

Division 17 Front reflectors

121 Compulsory front reflectors on trailers

- (1) A front-facing white or yellow reflector must be fitted towards each side of the front of:
 - (a) a semi-trailer, except a pole-type trailer, and
 - (b) the front cross-bar or bolster of a pole-type trailer, and
 - (c) a trailer that is at least 2.2 metres wide.
- (2) Each reflector must have its centre:
 - (a) at the same height above ground level, and
 - (b) not over 1.5 metres above ground level, and
 - (c) not over 400 millimetres from the nearer side of the vehicle.
- (3) Additional front-facing reflectors may be fitted to a trailer mentioned in subclause (1) in accordance with clause 122.

122 Optional front reflectors

- (1) A motor vehicle with 4 or more wheels, or a trailer, may have 1 or more front-facing white or yellow reflectors fitted towards each side of its front.
- (2) A motor vehicle with less than 4 wheels may have 1 or more front-facing white or yellow reflectors.
- (3) The centre of at least 1 reflector on each side of the front of the vehicle must be:
 - (a) at the same height above ground level as the centre of the other reflector, and
 - (b) the same distance from the longitudinal axis of the vehicle as the centre of the other reflector, and
 - (c) at least:
 - (i) for a vehicle with a width under 1300 millimetres—400 millimetres from the centre of the other reflector, and
 - (ii) for another vehicle—600 millimetres from the centre of the other reflector.
- (4) For subclause (3) (c), the width of a vehicle is measured disregarding any anti-skid device mounted on wheels, central tyre inflation systems, lights, mirrors, reflectors, signalling devices and tyre pressure gauges.

Division 18 Spot and search lights

123 Spot and search lights

A motor vehicle may be equipped with a spot or search light.

Division 19 Other lights, reflectors, rear marking plates or signals

124 Other lights and reflectors

- (1) A vehicle may be fitted with any light or reflector not mentioned in this Schedule.
- (2) However, unless subclause (3) or (4) applies, a vehicle must not display or be fitted with:
 - (a) a light that flashes or rotates, or
 - (b) a light or reflector that:
 - (i) shows a red light to the front, or
 - (ii) shows a white light to the rear, or
 - (iii) is shaped or located in a way that reduces the effectiveness of a light or reflector that is required to be fitted to the vehicle under this Schedule, or

- (iv) shows a blue light.
- (3) Despite clause 17 and any requirement of a third edition ADR, an emergency vehicle or police vehicle may be fitted with any light or reflector.
- (4) Despite clause 17 and any requirement of a third edition ADR, the following vehicles may be fitted with a light or lights, at least one of which must be mounted on top of the vehicle, capable of displaying a flashing or rotating light:
 - (a) ambulances,
 - (b) police vehicles,
 - (c) fire fighting vehicles,
 - (d) mines rescue or other rescue vehicles,
 - (e) Red Cross vehicles used for conveyance of blood for urgent transfusions,
 - (f) public utility service vehicles,
 - (g) tow-trucks,
 - (h) motor breakdown service vehicles,
 - (i) vehicles used for the delivery of milk that are required to stop at frequent intervals,
 - (j) buses used solely or principally for the conveyance of children to or from school,
 - (k) vehicles exceeding the length, width and height limits of this Schedule,
 - (l) vehicles frequently used to transport loads that exceed the maximum length, width and height limits of this Schedule,
 - (m) vehicles used to escort vehicles referred to in paragraph (k) or (l),
 - (n) vehicles used by the Authority,
 - (o) vehicles used by an employee of a council of a local government area for the purposes of enforcing excess weight limits legislation,
 - (p) State Emergency Service vehicles,
 - (q) such other vehicles as are approved by the Authority.
- (5) Despite subclause (4), a police vehicle is not required to have a light mounted on top of the vehicle.
- (6) Despite subclause (4), a vehicle used by the Authority is not required to have a light mounted on top of the vehicle.

- (7) A light that may be fitted under subclause (4) must be capable of displaying:
- (a) in the case of a police vehicle, an ambulance, a fire fighting vehicle, a vehicle used by a Traffic Commander or Traffic Emergency Patroller (appointed or employed by the Authority), a State Emergency Service vehicle or a vehicle used by an accredited rescue unit (within the meaning of the *State Emergency and Rescue Management Act 1989*)—a blue or red light, or
 - (b) in the case of a Red Cross vehicle, a mines rescue or other rescue vehicle or an emergency vehicle within the meaning of the *Road Rules 2014* (other than a vehicle referred to in paragraph (a))—a red light, or
 - (c) in the case of a vehicle used by the Authority or a vehicle used by a council of a local government area for the purposes of enforcing excess weight limits legislation—a crimson light, or
 - (d) in the case of a fire brigade emergency site command vehicle—a green light, or
 - (e) in the case of any other vehicle—a yellow light unless otherwise approved by the Authority.
- (8) The lens of any such light must not be visible, either directly or indirectly, to the driver of the motor vehicle or trailer to which it is fitted when that driver is seated in the normal driving position.
- (9) The light from any such light mounted on the top of the vehicle must be visible in normal sunlight from a distance of at least 200 metres to a driver approaching that vehicle from any direction.
- (10) Subclause (7) does not apply to the extent that it is inconsistent with a requirement of the *Road Transport (Mass, Loading and Access) Regulation 2005* (or any regulation that replaces that regulation) relating to oversize vehicles or pilot or escort vehicles.
- (11) In this clause, **excess weight limits legislation** means:
- (a) the *Heavy Vehicle National Law (NSW)*, or
 - (b) the *Road Transport (Mass, Loading and Access) Regulation 2005* or any regulation that replaces that Regulation.

125 Flashing direction indicator lights

- (1) A motor vehicle that:
- (a) is specified in clause 124 (4), and
 - (b) has direction indicator lights that show yellow light to the front,
- may be equipped with a device that will cause the direction indicator lights fitted to

the front and rear and on both sides of the vehicle, and any trailer connected to the vehicle, to flash simultaneously and regularly at a rate of not less than 60 and not more than 120 flashes per minute.

- (2) When all such lights fitted to a motor vehicle and trailer (if any) are flashing simultaneously, there must be an indicator that will inform the driver, by visible and audible means, that the lights are flashing.

126 Flashing lights on other vehicles—street vending vehicles

Street vending vehicles must be fitted with a flashing warning light mounted on the roof of the vehicle. Any such light must:

- (a) be capable of displaying a rotating, flashing, yellow coloured light, and
- (b) commence to emit light within 1 second of being switched on, and
- (c) when switched on, flash regularly at a rate of not less than 60 times per minute, and
- (d) be connected to an indicator that will inform the driver, by visible and audible means, that the light is flashing, and
- (e) emit light that is visible in normal sunlight from a distance of at least 200 metres to a driver approaching the vehicle from any direction.

127 (Repealed)

128 Signalling devices

- (1) This clause applies to a motor vehicle if:
 - (a) the vehicle is not fitted with a brake light or direction indicator light mentioned in Division 9 or 11, and
 - (b) the construction of the vehicle would otherwise prevent the driver from hand signalling an intention:
 - (i) to turn or move the vehicle to the right, or
 - (ii) to stop or suddenly reduce the speed of the vehicle.
- (2) The vehicle must be fitted with a mechanical signalling device or a pair of turn signals.

129 Mechanical signalling devices

- (1) A mechanical signalling device must:
 - (a) be fitted to the right side of the vehicle, and
 - (b) be able to be operated by the driver from a normal driving position, and

- (c) consist of a white or yellow representation of an open human hand at least 15 centimetres long, and
 - (d) be constructed so that the driver of the vehicle can keep the device:
 - (i) in a neutral position so it is unlikely that the driver of another vehicle or anyone else would regard it as a signal, and
 - (ii) in a horizontal position with the palm of the hand facing forwards and the fingers pointing out at a right angle to the vehicle to signal an intention to turn or move right, and
 - (iii) with the palm of the hand facing forwards and the fingers pointing upwards to signal an intention to stop or reduce speed suddenly.
- (2) When the mechanical signalling device is in a position mentioned in subclause (1) (d) (ii) or (iii), the complete hand must be clearly visible, from both the front and the rear of the vehicle, at a distance of 30 metres.

130 Turn signals

A turn signal must:

- (a) consist of a steady or flashing illuminated yellow sign at least 15 centimetres long and 25 millimetres wide that:
 - (i) when in operation—is kept horizontal, and
 - (ii) when not in operation—is kept in a position so it is unlikely that the driver of another vehicle or anyone else would regard it as a signal, and
- (b) be fitted to the side of the motor vehicle at least 50 centimetres and not over 2.1 metres above ground level, in a position so the driver of the vehicle, from the normal driving position, can see whether the signal is in operation, and
- (c) be able to be operated by the driver from the normal driving position, and
- (d) when in operation, be visible from both the front and rear of the vehicle at a distance of 30 metres.

Division 20 Vehicles not required to have lights or reflectors

131 Certain vehicles used in daylight

This Part does not apply to a vehicle built before 1931 that is used only in the daylight.

132 Certain vehicles used for exhibition purposes

This Part does not apply to a vehicle built before 1946 that is used mainly for exhibition purposes.

Part 6 Braking systems

Note—

This Part sets out the braking system requirements for vehicles to ensure that they can be reliably slowed or stopped even if a part of a braking system fails, and to ensure that a vehicle can be prevented from rolling away when parked.

The Part also includes special requirements for braking systems on B-doubles and road trains to ensure that the braking systems on the component vehicles are compatible. The special requirements do not apply to a road train that is 19 metres long or less.

Division 1 Brake requirements for all vehicles

133 Parts of a braking system

- (1) A brake tube or hose fitted to a vehicle must:
 - (a) be manufactured from a material appropriate to its intended use in the vehicle, and
 - (b) be long enough to allow for the full range of steering and suspension movements of the vehicle, and
 - (c) be fitted to prevent it being damaged during the operation of the vehicle by:
 - (i) a source of heat, or
 - (ii) any movement of the parts to which it is attached or near.
- (2) Each component of the braking system of a vehicle must comply with the design and performance requirements of:
 - (a) a relevant Australian Standard or British Standard as in force when this subclause commenced, or
 - (b) a relevant standard approved by any of the following bodies, and as in force when this subclause commenced:
 - (i) American Society of Automotive Engineers,
 - (ii) American National Standards Institute,
 - (iii) Japanese Standards Association,
 - (iv) Deutsches Institut für Normung,
 - (v) International Organization for Standardization.

134 Provision for wear

The braking system of a vehicle must allow for adjustment to take account of normal wear.

135 Supply of air or vacuum to brakes

- (1) If air brakes are fitted to a vehicle:
 - (a) the compressor supplying air to the brakes must be able to build up air pressure to at least 80% of the governor cut-out pressure in not over 5 minutes after the compressed air reserve is fully used up, and
 - (b) (Repealed)
 - (c) there must be an automatic or manual condensate drain valve at the lowest point of each air brake reservoir in the system, and
 - (d) any spring brake fitted to the vehicle must not operate before the warning mentioned in clause 139 (4) (a) or 142 (3) (a) has been given.
- (2) If vacuum brakes are fitted to a vehicle, the vacuum supply must be able to build up vacuum:
 - (a) to the level when the warning signal mentioned in clause 139 (4) (a) or 142 (3) (a) no longer operates within 30 seconds after the vacuum reserve is fully used up, and
 - (b) to the normal working level within 60 seconds after the vacuum reserve is fully used up.

136 Performance of braking systems

- (1) One sustained application of the brake of a motor vehicle built after 1930, or a combination that includes a motor vehicle built after 1930, must be able to produce the performance mentioned in subclauses (2) to (7):
 - (a) when the vehicle or combination is on a dry, smooth, level road surface, free from loose material, and
 - (b) whether or not the vehicle or combination is loaded, and
 - (c) without part of the vehicle or combination moving outside a straight path:
 - (i) centred on the longitudinal axis of the vehicle or combination before the brake was applied, and
 - (ii) 3.7 metres wide.
- (2) The braking system of a motor vehicle or combination with a gross mass under 2.5 tonnes must bring the vehicle or combination from a speed of 35 kilometres an hour to a stop within:
 - (a) 12.5 metres when the service brake is applied, and

- (b) 30 metres when the emergency brake is applied.
- (3) The braking system of a motor vehicle or combination with a gross mass of at least 2.5 tonnes must bring the vehicle or combination from a speed of 35 kilometres an hour to a stop within:
 - (a) 16.5 metres when the service brake is applied, and
 - (b) 40.5 metres when the emergency brake is applied.
- (4) The braking system of a motor vehicle or combination with a gross mass under 2.5 tonnes must decelerate the vehicle or combination, from any speed at which the vehicle or combination can travel, by an average of at least:
 - (a) 3.8 metres per second per second when the service brake is applied, and
 - (b) 1.6 metres per second per second when the emergency brake is applied.
- (5) The braking system of a motor vehicle or combination with a gross mass of at least 2.5 tonnes must decelerate the vehicle or combination, from any speed at which the vehicle or combination can travel, by an average of at least:
 - (a) 2.8 metres per second per second when the service brake is applied, and
 - (b) 1.1 metres per second per second when the emergency brake is applied.
- (6) The braking system of a motor vehicle or combination with a gross mass under 2.5 tonnes must achieve a peak deceleration of the vehicle or combination, from any speed at which the vehicle or combination can travel, of at least:
 - (a) 5.8 metres per second per second when the service brake is applied, and
 - (b) 1.9 metres per second per second when the emergency brake is applied.
- (7) The braking system of a motor vehicle or combination with a gross mass of at least 2.5 tonnes must achieve a peak deceleration of the vehicle or combination, from any speed at which the vehicle or combination can travel, of at least:
 - (a) 4.4 metres per second per second when the service brake is applied, and
 - (b) 1.5 metres per second per second when the emergency brake is applied.
- (8) The parking brake of a vehicle or combination must be able to hold the vehicle or combination stationary on a 12% gradient.

Division 2 Motor vehicle braking systems

137 What braking system a motor vehicle must have

- (1) In this clause:

independent brake, for a vehicle, means a brake that is operated entirely separately from any other brake on the vehicle, except for any drum, disc or part, on which a shoe, band or friction pad makes contact, that is common to 2 or more brakes.

- (2) A motor vehicle with 4 or more wheels built, or used, mainly for transporting goods or people by road must be fitted with:
 - (a) a braking system that:
 - (i) consists of brakes fitted to all wheels of the vehicle, and
 - (ii) has at least 2 separate methods of activation, arranged so effective braking remains on at least 2 wheels if a method fails, or
 - (b) 2 independent brakes, each of which, when in operation, acts directly on at least half the number of wheels of the vehicle.
- (3) The braking system of a motor vehicle mentioned in subclause (2) that was built after 1945 must have a service brake operating on all wheels that, when applied:
 - (a) acts directly on the wheels and not through the vehicle's transmission, or
 - (b) acts on a shaft between a differential of the vehicle and a wheel.
- (4) The braking system of a motor vehicle with 4 or more wheels must have a parking brake that:
 - (a) is held in the applied position by direct mechanical action without the intervention of an electrical, hydraulic or pneumatic device, and
 - (b) is fitted with a locking device that can hold the brake in the applied position, and
 - (c) has its own separate control.
- (5) The parking brake may also be the emergency brake.
- (6) If 2 or more independent brakes are fitted to a motor vehicle with 4 or more wheels, the brakes must be arranged so brakes are applied to all the wheels on at least 1 axle of the vehicle when any brake is operated.
- (7) A motor bike or motor trike must be fitted with:
 - (a) 2 independent brakes, or
 - (b) a single brake that acts directly on all wheels of the vehicle and is arranged so effective braking remains on at least 1 wheel if a part of the system fails.
- (8) Subclause (7) applies to a motor bike with a sidecar attached as if the sidecar were not attached.

- (9) A motor trike must have a parking brake that is held in the applied position by mechanical means.

138 Operation of brakes on motor vehicles

The braking system on a motor vehicle must be arranged to allow the driver of the motor vehicle to apply the brakes from a normal driving position.

139 Air or vacuum brakes on motor vehicles

- (1) If a motor vehicle has air brakes, the braking system of the vehicle must include at least 1 air storage tank.
- (2) If a motor vehicle has vacuum brakes, the braking system of the vehicle must include at least 1 vacuum storage tank.
- (3) An air or vacuum storage tank must be built so the service brake can be applied to meet the performance standards of clause 136 at least twice if the engine of the vehicle stops or the source of air or vacuum fails.
- (4) An air or vacuum storage system must:
 - (a) be built to give a visible or audible warning to the driver, while in a normal driving position, of a lack of air or vacuum that would prevent the service brake from being applied to meet the performance standards of clause 136 at least twice, and
 - (b) be safeguarded by a check valve or other device against loss of air or vacuum if the supply fails or leaks.
- (5) However, subclause (4) (a) does not apply to a vehicle with a GVM of 4.5 tonnes or less that is fitted with an air or vacuum assisted braking system.
- (6) If air or vacuum brakes are fitted to a motor vehicle equipped to tow a trailer, the brakes of the vehicle must be able to stop the vehicle at the performance standards for emergency brakes under clause 136 if the trailer breaks away.
- (7) The braking system of a motor vehicle equipped to tow a trailer fitted with air brakes must include protection against loss of supply line air or brake control signal air.
- (8) The protection mentioned in subclause (7) must:
 - (a) operate automatically if a brake supply line hose connecting the motor vehicle and a trailer fails, and
 - (b) maintain enough air pressure to allow the brakes to be applied to meet performance standards for emergency brakes under clause 136, and
 - (c) include a visible or audible warning to the driver.

Division 3 Trailer braking systems

140 What brakes a trailer must have

- (1) A trailer with a GTM over 750 kilograms must have brakes that operate on at least 1 wheel at each end of 1 or more axles of the trailer.
- (2) A semi-trailer or converter dolly with a GTM over 2 tonnes must have brakes that operate on all its wheels.

141 Operation of brakes on trailers

- (1) The braking system of a trailer with a GTM over 2 tonnes must allow the driver of a motor vehicle towing the trailer to operate the brakes from a normal driving position.
- (2) However, subclause (1) does not apply to an unloaded converter dolly that weighs under 3 tonnes if the motor vehicle towing the converter dolly has a GVM over 12 tonnes.
- (3) The brakes on a trailer with a GTM over 2 tonnes must:
 - (a) operate automatically and quickly if the trailer breaks away from the towing vehicle, and
 - (b) remain in operation for at least 15 minutes after a break-away, and
 - (c) be able to hold the trailer on a 12% gradient while in operation after a break-away.

142 Air or vacuum brakes on trailers

- (1) If a trailer has air brakes, its braking system must include at least 1 air storage tank.
- (2) If a trailer has vacuum brakes, its braking system must include at least 1 vacuum storage tank.
- (3) An air or vacuum storage system must:
 - (a) be built to give a visible or audible warning to the driver of the towing vehicle, while in a normal driving position, of a lack of air or vacuum that would prevent the brakes from meeting the performance standards of clause 136, and
 - (b) be safeguarded by a check valve or other device against loss of air or vacuum if the supply fails or leaks.
- (4) Subclauses (1), (2) and (3) do not apply to a trailer with a GTM of 2 tonnes or less.

Division 4

143-153 (Repealed)

Part 7 Control of emissions

Note—

This Part sets out requirements to ensure that motor vehicles do not emit too much smoke or noise and that exhaust gases cannot enter the passenger compartment of a vehicle.

Division 1 Crank case gases and visible emissions

154 Crank case gases

- (1) This clause applies to a motor vehicle with 4 or more wheels that is powered by a petrol engine and was built after 1971.
- (2) The vehicle must be built to prevent, or fitted with equipment that prevents, crank case gases from escaping to the atmosphere.

155 Visible emissions

- (1) This clause applies to a motor vehicle that is propelled by an internal combustion engine and was built after 1930.
- (2) The vehicle must not emit visible emissions for a continuous period of at least 10 seconds.
- (3) However, this clause does not apply to emissions that are visible only because of heat or the condensation of water vapour.

Division 2 Exhaust systems

156 Exhaust systems

- (1) The outlet of the exhaust system fitted to a motor vehicle (except a bus) must extend:
 - (a) behind the back seat, and
 - (b) at least 40 millimetres beyond the outermost joint of the floorpan that is not continuously welded or permanently sealed, and
 - (c) to the edge of the vehicle, if:
 - (i) the body of the vehicle is permanently enclosed, and
 - (ii) the vehicle is not fitted with a vertical exhaust system, and
 - (d) no further than the edge of the vehicle at its widest point.
- (2) The outlet must discharge the main exhaust flow to the air:
 - (a) if the vehicle is fitted, or required under a law of this jurisdiction to be fitted, with an exhaust system with a vertical outlet pipe:

- (i) at an angle above the horizontal, and
 - (ii) at least 150 millimetres above the cab of the vehicle, and
 - (iii) rearwards or to the right of the vehicle, and
 - (b) in any other case:
 - (i) horizontally or at an angle of not over 45° downwards, and
 - (ii) under 750 millimetres above ground level, and
 - (iii) rearwards or to the right of the vehicle.
- (3) An exposed section of a vertical exhaust system fitted to a motor vehicle (except a bus) must be positioned or shielded to prevent injury.
- (4) The outlet of the exhaust system fitted to a bus must:
- (a) be as near as practicable to the rear of the vehicle, and
 - (b) extend no further than the edge of the bus at its widest point.
- (5) The outlet must discharge the main exhaust flow to the air:
- (a) if the bus is fitted, or required under a law of this jurisdiction to be fitted, with an exhaust system with a vertical outlet pipe:
 - (i) behind the passenger compartment, and
 - (ii) at an angle above the horizontal, and
 - (iii) upwards or rearwards, and
 - (b) in any other case:
 - (i) horizontally or at an angle of not over 45° downwards, and
 - (ii) rearwards or to the right of the vehicle.
- (6) A vertical exhaust system fitted to a motor vehicle must:
- (a) if the vehicle is fitted with an exhaust system with a vertical outlet pipe that does not direct the main exhaust flow straight up—direct the flow rearwards at an angle within 0° to 45° of the longitudinal centre line of the vehicle, and
 - (b) if a rain cap is fitted to the outlet pipe—be installed so the hinge of the cap is at an angle of 90° (plus or minus 10°) to the longitudinal centre line of the vehicle when viewed from above.



Bus exhaust outlet pipe

Division 3 Noise emissions

157 Silencing device for exhaust systems

A motor vehicle propelled by an internal combustion engine must be fitted with a silencing device through which all the exhaust from the engine passes.

158 Stationary noise levels—car-type vehicles and motor bikes and trikes

(1) In this clause:

car-type vehicle means:

- (a) a car, or
- (b) a utility truck, panel van, or another motor vehicle derived from a car design, or
- (c) another motor vehicle with 4 or more wheels that is built mainly to carry not over 9 people including the driver.

(2) The stationary noise level of a car-type vehicle, or motor bike or trike, must not exceed:

- (a) for a car-type vehicle built after 1982—90 dB(A), or
- (b) for another car-type vehicle—96 dB(A), or
- (c) for a motor bike or trike built after February 1985—94 dB(A), or
- (d) for another motor bike or trike—100 dB(A).

159 Stationary noise levels—other vehicles with spark ignition engines

(1) This clause applies to a motor vehicle (except a motor vehicle to which clause 158 applies) with a spark ignition engine.

(2) For a motor vehicle built before 1 July 1983 that has:

- (a) a GVM of more than 3.5 tonnes, the stationary noise level of the motor vehicle must not exceed:
 - (i) 94 dB(A) if the exhaust of the vehicle is 1.5 metres or more above the ground, or
 - (ii) 98 dB(A) if the exhaust of the vehicle is less than 1.5 metres above the ground, or
 - (b) a GVM of 3.5 tonnes or less, the stationary noise level of the motor vehicle must not exceed:
 - (i) 88 dB(A) if the exhaust of the vehicle is 1.5 metres or more above the ground, or
 - (ii) 92 dB(A) if the exhaust of the vehicle is less than 1.5 metres above the ground.
- (3) For a motor vehicle built on or after 1 July 1983 that has:
- (a) a GVM of more than 3.5 tonnes, the stationary noise level of the motor vehicle must not exceed:
 - (i) 91 dB(A) if the exhaust of the vehicle is 1.5 metres or more above the ground, or
 - (ii) 95 dB(A) if the exhaust of the vehicle is less than 1.5 metres above the ground, or
 - (b) a GVM of 3.5 tonnes or less, the stationary noise level of the motor vehicle must not exceed:
 - (i) 85 dB(A) if the exhaust of the vehicle is 1.5 metres or more above the ground, or
 - (ii) 89 dB(A) if the exhaust of the vehicle is less than 1.5 metres above the ground.

160 Stationary noise levels—other vehicles with diesel engines

- (1) This clause applies to a motor vehicle (except a motor vehicle to which clause 158 applies) with a diesel engine.
- (2) For a motor vehicle built before 1 July 1980 that has:
 - (a) (Repealed)
 - (b) a GVM of more than 3.5 tonnes but no more than 4.5 tonnes, the stationary noise level of the motor vehicle must not exceed:

- (i) 103 dB(A) if the exhaust of the vehicle is 1.5 metres or more above the ground, or
 - (ii) 107 dB(A) if the exhaust of the vehicle is less than 1.5 metres above the ground, or
 - (c) a GVM of 3.5 tonnes or less, the stationary noise level of the motor vehicle must not exceed:
 - (i) 101 dB(A) if the exhaust of the vehicle is 1.5 metres or more above the ground, or
 - (ii) 105 dB(A) if the exhaust of the vehicle is less than 1.5 metres above the ground.
- (3) For a motor vehicle built on or after 1 July 1980 but before 1 July 1983 that has:
- (a) (Repealed)
 - (b) a GVM of more than 3.5 tonnes but no more than 4.5 tonnes, the stationary noise level of the motor vehicle must not exceed:
 - (i) 100 dB(A) if the exhaust of the vehicle is 1.5 metres or more above the ground, or
 - (ii) 104 dB(A) if the exhaust of the vehicle is less than 1.5 metres above the ground, or
 - (c) a GVM of 3.5 tonnes or less, the stationary noise level of the motor vehicle must not exceed:
 - (i) 98 dB(A) if the exhaust of the vehicle is 1.5 metres or more above the ground, or
 - (ii) 102 dB(A) if the exhaust of the vehicle is less than 1.5 metres above the ground.
- (4) For a motor vehicle built on or after 1 July 1983 that has:
- (a) (Repealed)
 - (b) a GVM of more than 3.5 tonnes but no more than 4.5 tonnes, the stationary noise level of the motor vehicle must not exceed:
 - (i) 97 dB(A) if the exhaust of the vehicle is 1.5 metres or more above the ground, or
 - (ii) 101 dB(A) if the exhaust of the vehicle is less than 1.5 metres above the ground, or

- (c) a GVM of 3.5 tonnes or less, the stationary noise level of the motor vehicle must not exceed:
- (i) 95 dB(A) if the exhaust of the vehicle is 1.5 metres or more above the ground, or
 - (ii) 99 dB(A) if the exhaust of the vehicle is less than 1.5 metres above the ground.

161 Measurement of stationary noise levels

For this Division, the stationary noise level of a motor vehicle is to be measured in accordance with the test method mentioned in the *Roadworthiness Guidelines* approved by the Ministerial Council for Road Transport and in force immediately before the commencement of this clause.

Note—

The *Roadworthiness Guidelines* were published by the National Road Transport Commission (subsequently replaced by the National Transport Commission) and are available from Ausinfo Bookshops. The Ministerial Council was the Ministerial Council for Road Transport which was established by a national agreement called the *Heavy Vehicles Agreement*. The Council's functions are now exercised by the Australian Transport Council, which was established on 11 June 1993.

Part 8 LPG and CNG fuel systems

Note—

This Part sets out requirements to ensure that liquid petroleum gas (LPG) and compressed natural gas (CNG) fuel systems are safely installed in motor vehicles and that vehicles with LPG or CNG fuel systems installed can be identified as LPG-powered or CNG-powered vehicles.

162 Vehicles equipped to run on LPG or CNG

- (1) A motor vehicle equipped to run on LPG must comply with the requirements for the use of LPG in vehicles in:
 - (a) Australian/New Zealand Standard AS/NZS 1425:2007 *LP Gas fuel systems for vehicle engines*, or
 - (b) if an earlier version of the standard was current when the vehicle was first equipped to run on LPG—that version.
- (2) A vehicle equipped to run on LPG must have fixed conspicuously to the front and rear number-plates a label that is:
 - (a) made of durable material, and
 - (b) at least 25 millimetres wide and 25 millimetres high, and
 - (c) retroreflective red conforming to Australian and New Zealand Standard AS/NZS 1906.1:2007 *Retroreflective materials and devices for road traffic control*

purposes—Retroreflective sheeting, and

- (d) marked “LPG” in white capital letters at least 10 millimetres high.
- (3) A motor vehicle equipped to run on CNG must comply with the requirements for the use of CNG in vehicles in:
 - (a) Australian/New Zealand Standard AS/NZS 2739:2003*Natural Gas (CNG) fuel systems for vehicle engines, or*
 - (b) if an earlier version of the standard was current when the vehicle was first equipped to run on CNG—that version.
- (4) A vehicle equipped to run on CNG must have fixed conspicuously to the front and rear number-plates a label that is:
 - (a) made of durable material, and
 - (b) circular with a diameter of at least 35 millimetres, and
 - (c) retroreflective red conforming to Australian and New Zealand Standard AS/NZS 1906.1:2007*Retroreflective materials and devices for road traffic control purposes—Retroreflective sheeting, and*
 - (d) marked “CNG” in white capital letters at least 10 millimetres high.
- (5) In this clause:
 - CNG** means compressed natural gas.
 - LPG** means liquid petroleum gas.

Part 9

163, 164 (Repealed)

Part 10 Mechanical connections between vehicles

Note—

This Part sets out various requirements to ensure that the couplings used when operating motor vehicles and trailers in combinations are strong enough to hold them together. The requirements in this Part about the mechanical connections between vehicles in a road train do not apply to a road train 19 metres long or less.

Division 1 Couplings on all types of vehicles

165 General coupling requirements

- (1) A fifth wheel coupling, the mating parts of a coupling, a kingpin or a towbar must not be used for a load more than the manufacturer’s load rating.

- (2) A kingpin must be used only with a fifth wheel coupling that has a corresponding jaw size.

Example

An adaptor must not be used to fit a kingpin to a fifth wheel coupling.

- (3) The mating parts of a coupling used to connect a semi-trailer to a towing vehicle must not allow the semi-trailer to roll to an extent that makes the towing vehicle unstable.

166 Drawbar couplings

- (1) A coupling for attaching a trailer, except a semi-trailer or pole-type trailer, to a towing vehicle must be built and fitted so that:
- (a) the coupling is equipped with a positive locking mechanism, and
 - (b) the positive locking mechanism can be released regardless of the angle of the trailer to the towing vehicle.
- (2) A coupling fitted to a trailer first registered on or after 1 August 1963 must have clearly and permanently stamped, moulded or otherwise branded on its main component:
- (a) means of identifying its manufacturer, and
 - (b) the maximum gross weight of the trailer it is designed to tow.
- (3) If the trailer is in a combination and is not fitted with break-away brakes in accordance with clause 141 (3), it must be connected to the towing vehicle by at least 1 chain, cable or other flexible device, as well as the coupling required by subclause (1).
- (4) Any such safety connection must be as short as practicable and be so connected and affixed that:
- (a) it is not liable to accidental disconnection but is readily detachable from the towing vehicle, and
 - (b) it permits all normal angular movements of the coupling without more slack than is necessary, and
 - (c) it will prevent the forward end of the drawbar from striking the ground in the event of accidental disconnection of the coupling, and
 - (d) if it consists of more than one chain or wire rope, the chains or wire ropes are in a crossed-over position.
- (5) Any chain or wire rope in such a safety connection must:
- (a) if a chain, be of welded iron links, and

(b) if a wire rope, have a strength of at least that of a chain of the same diameter, and

(c) be of a size specified in the following table:

Table

Gross weight of trailer	Minimum size of chain or wire rope
Up to 500 kilograms	6.3 millimetres diameter
Exceeding 500 kilograms but not exceeding 1.3 tonnes	9.5 millimetres diameter
Exceeding 1.3 tonnes	12.6 millimetres diameter

Division 2

167-179 (Repealed)

Part 11 Other matters

180 Restored vehicles

For the purposes of this Schedule, a restored vehicle is taken to have been built when it was originally built and not when it was restored.

181 Retractable axles

(1) For the purposes of this Schedule, a retractable axle is taken to be an axle only when it is in the lowered position.

(2) In this clause:

retractable axle means an axle with a means of adjustment enabling it to be raised or lowered relative to the other axles in the axle group.

182 Measurement of distance between parallel lines

For the purposes of this Schedule, a distance between 2 parallel lines is measured at right angles between the lines.

183 Interpretation of certain second edition ADRs

The words “left” and “right” in the following second edition ADRs have the opposite meaning in the application of the ADRs, in accordance with this Schedule, to a motor vehicle with a left-hand drive:

(a) ADR 8 Safety Glazing Material

(b) ADR 14 Rear Vision Mirrors

- (c) ADR 16 Windscreen Wipers and Washers
- (d) ADR 18 Instrumentation
- (e) ADR 35 Commercial Vehicle Brake Systems.

Note—

The following table contains a list of some terms used in the third edition ADRs and the corresponding term used in this Schedule.

Third edition ADRs	This Schedule
dipped-beam headlamp	low-beam (for a headlight)
front fog lamp	front fog light
rear fog lamp	rear fog light
wheelguard	mudguard
main-beam headlamp	high-beam (for a headlight)
reversing lamp	reversing light
direction indicator lamp	direction indicator light
stop lamp	brake light
rear registration plate lamp	number-plate light
front position (side) lamp	parking light
rear position (side) lamp	tail light
end-outline marker lamp	front or rear clearance light
external cabin lamp	external cabin light
internal lamp	interior light
side marker lamp	side marker light
daytime running lamp	daytime running light
rear reflex reflector, non-triangular	rear reflector
front reflex reflector, non-triangular	front reflector
side reflex reflector, non-triangular	side reflector

Part 12 Special provisions for buses not subject to third edition ADRs

Division 1 General

184 Application of Part

This Part applies to all buses except those buses required by this Schedule to be

constructed and equipped so as to comply with the third edition ADRs.

185 Requirements of this Part additional to other provisions of Schedule

- (1) In addition to complying with the other provisions of this Schedule, a bus must be constructed or equipped with the items of equipment set out in this Part.
- (2) The Authority may approve of a modification of all or any of the provisions of Division 2 in the case of a bus equipped to seat not more than 12 adults including the driver and used or intended to be used for the conveyance of school children or children with disabilities or employees of the owner or for a similar purpose if the Authority is satisfied that it is so constructed and equipped that it is safe to be used for that purpose.

Division 2 Additional requirements for buses

186 Driver's guard-rail

Where necessary, there must be a suitable guard-rail or panel fitted to a bus:

- (a) that will prevent any passenger from accidentally coming into contact with the driver or the control levers of the vehicle, and
- (b) that will prevent any passenger from obstructing the driver's view.

187 Inside mirror

A mirror must be suitably affixed to the inside of a bus that has such dimensions and is so affixed that it will reflect to the driver, while retaining his or her normal driving position, a view of doors and door approaches of the vehicle.

188 Fuel tank

- (1) The fuel tank and the fuel tank filler pipe must not be located in the interior of the bus, in the engine compartment, or in any separate compartment for the driver.
- (2) The fuel tank filler pipe must be situated so that it is not less than 900 millimetres from either side of any exit (including any emergency exit) and must be arranged so that any overflow or leakage of fuel cannot accumulate.

189 Emergency exits for buses

- (1) In the case of a single-deck bus not provided for in subclause (2), there must be:
 - (a) at least one emergency exit at the extreme rear of the passenger compartment measuring not less than 1.3 metres by 530 millimetres, or
 - (b) at least one emergency exit fitted in the roof of the rear half of the passenger compartment having a minimum area of 7000 square centimetres and no

dimension less than 530 millimetres and, in the case of a bus first registered on or after 1 January 1963 that does not have a door accessible to passengers fitted in each side of the vehicle, there must be located in the rear half of the passenger compartment on the side on which a door is not fitted, an emergency exit measuring not less than 600 millimetres by 530 millimetres.

- (2) In the case of a single-deck bus with its engine or any other obstruction at its rear, there must be emergency means of exit as prescribed in subclause (1) (b) near the centre of the passenger compartment.
- (3) At the rear of a double-deck bus there must be at least two emergency exits, one situated above and the other below the level of the floor of the upper deck. Any such exit must measure not less than 1.3 metres by 530 millimetres.
- (4) However, it is sufficient compliance with subclause (3) if:
 - (a) the bus is fitted with a rear platform, and
 - (b) access from outside the vehicle to the platform extends transversely across the rear of the bus for a distance of not less than 450 millimetres, and
 - (c) there is at the rear of the bus at least one emergency exit situated above the level of the floor of the upper deck complying in other respects with the requirements of subclause (3).
- (5) Any emergency exit:
 - (a) must be clear of any obstruction, and
 - (b) must, where necessary, be equipped inside and outside with a suitable opening and closing device, and
 - (c) must be indicated by a prominent notice inside and outside the bus displaying the words "Emergency Exit".

190 Fire extinguishers

- (1) Every bus must be equipped with the number of fire extinguishers required by the Authority, being fire extinguishers of a type and capacity approved by the Authority.
- (2) A fire extinguisher with which a bus is equipped:
 - (a) must be maintained in good order and condition, and
 - (b) must be kept in a position where it is readily available for use.

191 Removable and opening interior fittings

Every hatch, cover, interior door and other removable or opening panel in the interior of a

bus must be adequately secured to prevent the likelihood of accidental opening or dislodgment.

Part 13

192-199 (Repealed)

Schedule 3 Fees

(Clause 77 (1) (a))

Matter for which fee payable	Fee
Part 1 Registration or renewal of registration of a motor vehicle or trailer	
(a) Motor lorry (other than an articulated motor lorry or prime mover) with a GVM of 12 tonnes or more:	
(i) for more than 6 months but not more than 1 year	\$271
(ii) for more than 3 months but not more than 6 months	\$135
(iii) for 3 months or less	\$67
(b) Articulated motor lorry:	
(i) for more than 6 months but not more than 1 year	\$405
(ii) for more than 3 months but not more than 6 months	\$202
(iii) for 3 months or less	\$100
(c) Prime mover:	
(i) for more than 6 months but not more than 1 year	\$271
(ii) for more than 3 months but not more than 6 months	\$135
(iii) for 3 months or less	\$67
(d) Tow truck with a GVM of 4.5 tonnes or more but less than 12 tonnes:	
(i) for more than 6 months but not more than 1 year	\$168
(ii) for more than 3 months but not more than 6 months	\$84
(iii) for 3 months or less	\$41
(e) Tow truck with a GVM of 12 tonnes or more:	

	(i) for more than 6 months but not more than 1 year	\$271
	(ii) for more than 3 months but not more than 6 months	\$135
	(iii) for 3 months or less	\$67
(f)	Trailer tow truck with a GVM of less than 4.5 tonnes:	
	(i) for more than 6 months but not more than 1 year	\$168
	(ii) for more than 3 months but not more than 6 months	\$84
	(iii) for 3 months or less	\$41
(g)	Trailer with a GVM of 4.5 tonnes or more:	
	(i) for more than 6 months but not more than 1 year	\$200
	(ii) for more than 3 months but not more than 6 months	\$100
	(iii) for 3 months or less	\$49
(h)	Bus or other vehicle (other than a public passenger vehicle) seating more than 8 adult persons with a GVM of less than 12 tonnes:	
	(i) for more than 6 months but not more than 1 year	\$168
	(ii) for more than 3 months but not more than 6 months	\$84
	(iii) for 3 months or less	\$41
(i)	Bus or other vehicle (other than a public passenger vehicle) seating more than 8 adult persons with a GVM of 12 tonnes or more:	
	(i) for more than 6 months but not more than 1 year	\$271
	(ii) for more than 3 months but not more than 6 months	\$135
	(iii) for 3 months or less	\$67
(j)	Bus or other vehicle (being a public passenger vehicle) seating more than 8 adult persons with a GVM of less than 12 tonnes:	
	(i) for more than 6 months but not more than 1 year	\$274
	(ii) for more than 3 months but not more than 6 months	\$137
	(iii) for 3 months or less	\$68

(k)	Bus or other vehicle (being a public passenger vehicle) seating more than 8 adult persons with a GVM of 12 tonnes or more:	
	(i) for more than 6 months but not more than 1 year	\$480
	(ii) for more than 3 months but not more than 6 months	\$240
	(iii) for 3 months or less	\$119
(l)	Taxi-cab (not licensed to operate in a transport district within the meaning of the Transport Administration Act 1988):	
	(i) for more than 6 months but not more than 1 year	\$274
	(ii) for more than 3 months but not more than 6 months	\$137
	(iii) for 3 months or less	\$68
(m)	Public passenger vehicle (other than a vehicle referred to elsewhere in this list):	
	(i) for more than 6 months but not more than 1 year	\$274
	(ii) for more than 3 months but not more than 6 months	\$137
	(iii) for 3 months or less	\$68
(n)	Any vehicle not referred to elsewhere in this list:	
	(i) for more than 6 months but not more than 1 year	\$62
	(ii) for more than 3 months but not more than 6 months	\$31
	(iii) for 3 months or less	\$15

Note—

Pursuant to clause 57 (2) (a) of this Regulation, the fees for registration or renewal of registration of a motor vehicle or trailer referred to in paragraphs (a)-(m) include a registration fee component and an inspection fee component for the applicable number of required inspections.

Part 2 Transfer of registration

(a)	Application made within 14 days after vehicle acquired	\$31
(b)	Application made more than 14 days after vehicle acquired	\$141

Part 3 Issue of 1 or 2 standard number-plates with same number

(a)	Initial issue	\$42
(b)	Replacement issue	\$42

Part 4 Trader's plate

- | | | |
|-----|--|-------|
| (a) | Issue of a trader's plate for a vehicle other than a motor bike: | |
| | (i) for 12 months | \$408 |
| | (ii) for one month | \$34 |
| (b) | Issue of a trader's plate for a motor bike: | |
| | (i) for 12 months | \$99 |
| | (ii) for one month | \$10 |

Part 5 Initial inspection of registrable vehicle under clause 56, 57 or 71, otherwise than in relation to exhaust emission levels

- | | | |
|-----|---|-------|
| (a) | Motor lorry (other than an articulated motor lorry or a prime mover) with a GVM of 4.5 tonnes or more but less than 12 tonnes | \$52 |
| (b) | Motor lorry (other than an articulated motor lorry or a prime mover) with a GVM of 12 tonnes or more | \$209 |
| (c) | Articulated motor lorry | \$343 |
| (d) | Prime mover | \$209 |
| (e) | Tow truck with a GVM of less than 12 tonnes | \$106 |
| (f) | Tow truck with a GVM of 12 tonnes or more | \$209 |
| (g) | Tow truck trailer with a GVM of less than 4.5 tonnes | \$106 |
| (h) | Trailer (other than a tow truck trailer) with a GVM of less than 4.5 tonnes | \$23 |
| (i) | Trailer (including a tow truck trailer) with a GVM of 4.5 tonnes or more | \$138 |
| (j) | Bus or other vehicle seating more than 8 adult persons with a GVM of less than 12 tonnes | \$106 |
| (k) | Bus or other vehicle seating more than 8 adult persons with a GVM of 12 tonnes or more | \$209 |
| (l) | Taxi-cab | \$106 |
| (m) | Public passenger vehicle (other than a vehicle referred to elsewhere in this list) | \$106 |
| (n) | Motor bike | \$23 |
| (o) | Any vehicle not referred to elsewhere in this list | \$38 |

Part 6 Further inspection of registrable vehicle that has failed earlier inspection under clause 56, 57 or 71

- | | | |
|-----|--|------|
| (a) | Where a vehicle may be used while a failure is being rectified | \$43 |
|-----|--|------|

- (b) Where a vehicle may not be used while a failure is being rectified \$87

Part 7 Inspection of registrable vehicle under clause 56 in relation to exhaust emission levels

- Conduct of inspection \$49

Part 8 Examiner's authority

- (a) Issue of original authority \$170

- (b) Issue of duplicate authority \$21

Part 9 Proprietor's authority

- (a) Issue of original authority \$339

- (b) Issue of duplicate authority \$21

Schedule 4 Registration charges for chargeable heavy vehicles

(Clause 76C)

Part 1 Interpretation

Note—

Some of the expressions defined in this Part are also defined in the Dictionary (whether in the same terms, substantially the same terms or different terms). A definition for an expression that is defined in this Part prevails over any different definition of the same expression set out in the Dictionary. The expressions defined in this Part are based on nationally agreed definitions for use in relation to determining registration charges for heavy vehicles.

1 Definitions

(1) In this Schedule:

articulated bus means a bus consisting of more than one rigid section with passenger access between the sections and the sections connected to one another so as to allow rotary movement between the sections.

axle means one or more shafts positioned in a line across a vehicle, on which one or more wheels intended to support the vehicle turn.

axle group means a single axle group, tandem axle group, twinsteer axle group, tri-axle group or quad-axle group.

B-double combination means a combination consisting of a prime mover towing 2 semi-trailers.

B-double lead trailer means a semi trailer that is nominated for use as the lead trailer in a B-double combination.

B-triple combination means a combination consisting of a prime mover towing 3

semi-trailers.

B-triple lead trailer means a semi trailer that is nominated for use as the lead trailer in a B-triple combination.

B-triple middle trailer means a semi trailer that is nominated for use as the second trailer in a B-triple combination.

bus means a motor vehicle, built mainly to carry people, that seats more than 9 adults (including the driver).

bus (type 1) means a rigid bus that has 2 axles and an MRC not exceeding 12 tonnes.

bus (type 2) means:

- (a) a rigid bus that has 2 axles and an MRC exceeding 12 tonnes, or
- (b) a rigid bus that has 3 or 4 axles.

converter dolly means a trailer with a fifth wheel coupling designed to support a semi trailer for hauling purposes.

dog trailer means a trailer with:

- (a) one axle group or single axle at the front that is steered by connection to the towing vehicle by a drawbar, and
- (b) one axle group or single axle at the rear.

drawbar means a part of a trailer (other than a semi trailer) that connects the trailer body to a coupling for towing purposes.

fifth wheel coupling means a device, other than the upper rotating element and the kingpin (which are parts of a semi trailer), used with a prime mover, semi trailer or a converter dolly to permit quick coupling and uncoupling and to provide for articulation.

lead trailer, in a combination, means the trailer that is, or that is to be, attached to the prime mover.

load carrying vehicle means a vehicle designed and constructed to haul or carry goods and wares in addition to any fuel, water, lubricants, tools and any other equipment or accessories necessary for normal operation of the vehicle.

long combination truck means a truck nominated to haul 2 or more trailers.

low loader means a gooseneck semi trailer with a loading deck no more than 1 metre above the ground.

low loader dolly means a mass-distributing device that:

- (a) is usually coupled between a prime mover and low loader, and
- (b) consists of a gooseneck rigid frame, and
- (c) does not directly carry any load on itself, and
- (d) is equipped with one or more axles, a kingpin and a fifth wheel coupling.

medium combination truck means a truck, other than a short combination truck, nominated to haul one trailer.

multi-combination prime mover means a prime mover nominated to haul 2 or more trailers.

nominated means nominated by the person applying for registration.

pig trailer means a trailer with one axle group or single axle near the middle of its load-carrying surface, and connected to the towing vehicle by a drawbar.

pole type trailer means a trailer that:

- (a) is attached to a towing vehicle by means of a pole or an attachment fitted to a pole, and
- (b) is ordinarily used for transporting loads, such as logs, pipes, structural members or other long objects, that are generally capable of supporting themselves like beams between supports.

prime mover means a motor vehicle designed to haul a semi trailer.

quad-axle group means a group of 4 axles, in which the horizontal distance between the centre-lines of the outermost axles is more than 3.2 metres but not more than 4.9 metres.

semi trailer means a trailer (including a pole type trailer) that has:

- (a) one axle group or single axle towards the rear, and
- (b) a means of attachment to a prime mover or a converter dolly that results in some of the load being imposed on the prime mover, or the converter dolly, as the case may be.

short combination prime mover means a prime mover nominated to haul one semi trailer.

short combination truck means a truck nominated to haul one trailer where, according to the nomination:

- (a) the combination has 6 axles or fewer, and
- (b) the maximum total mass that is legally allowable for the combination is 42.5 tonnes or less.

single axle means an axle not forming part of an axle group.

single axle group means a group of 2 or more axles, in which the horizontal distance between the centre-lines of the outermost axles is less than 1 metre.

special purpose vehicle—see clause 4.

special purpose vehicle (type O) means a special purpose vehicle (other than a special purpose vehicle (type P)):

- (a) built, or permanently modified, primarily for use on roads, and
- (b) that has at least one axle or axle group loaded in excess of the axle load limits specified in the Table to this definition.

Note—

Examples of this kind of vehicle are mobile cranes, fire engines, truck-mounted concrete pumps and boring plants. These kinds of vehicle may also fall within the definition of **special purpose vehicle (type T)** if they have no axle or axle group loaded in excess of the axle load limits specified in the Table to this definition.

Table—Axle load limits

Column 1	Column 2	Column 3
Item no	Type of axle or axle group	Axle load limit (tonnes)
1	Single axles:	
	(a) 2 tyres	6.0
	(b) 2 wide profile tyres (375mm to 450mm)	6.7
	(c) 2 wide profile tyres (over 450mm),	7.0
	(d) 4 or more tyres (on pig trailer)	8.5
	(e) 4 or more tyres (on other vehicles)	9.0
2	Twinsteer axle groups:	

	(a) non-load sharing suspensions	10.0
	(b) load sharing suspensions	11.0
3	Tandem axle groups:	
	(a) 4 tyres	11.0
	(b) 4 wide profile tyres (375mm to 450mm)	13.3
	(c) 4 wide profile tyres (over 450mm)	14.0
	(d) 6 tyres	13.0
	(e) 8 or more tyres (on pig trailers)	15.0
	(f) 8 or more tyres (on other vehicles)	16.5
4	Tri-axle groups:	
	(a) 6, 8 or 10 tyres	15.0
	(b) 6 wide profile tyres (375mm or over) on pig trailers	18.0
	(c) 6 wide profile tyres (375mm or over) on other vehicles	20.0
	(d) 12 or more tyres (on pig trailers)	18.0
	(e) 12 or more tyres (on other vehicles)	20.0

special purpose vehicle (type P) means a special purpose vehicle built, or permanently modified, primarily for:

- (a) off-road use, or
- (b) use on a road related area, or
- (c) use on an area of road that is under construction or repair.

Note—

Examples of this kind of vehicle are agricultural tractors, self-propelled agricultural harvesters, bulldozers, backhoes, graders and front-end loaders.

special purpose vehicle (type T) means a special purpose vehicle (other than a special purpose vehicle (type P)):

- (a) built, or permanently modified, primarily for use on roads, and
- (b) that has no axle or axle group loaded in excess of the axle load limits specified in the Table to the definition of **special purpose vehicle (type O)** in this subclause.

Note—

Examples of this kind of vehicle are mobile cranes, fire engines, truck-mounted concrete pumps and boring plants. These kinds of vehicle may also fall within the definition of **special purpose vehicle (type O)** if they have at least one axle or axle group loaded in excess of the axle load limits specified in the Table to that definition.

tandem axle group means a group of at least 2 axles, in which the horizontal distance between the centre-lines of the outermost axles is at least 1 metre but not more than 2 metres.

tri-axle group means a group of at least 3 axles, in which the horizontal distance between the centre-lines of the outermost axles is more than 2 metres, but not more than 3.2 metres.

truck means a rigid motor vehicle that is principally constructed as a load carrying vehicle.

truck (type 1) means a truck that has:

- (a) 2 axles and an MRC not exceeding 12 tonnes, or
- (b) 3 axles and an MRC not exceeding 16.5 tonnes, or
- (c) 4 or more axles and an MRC not exceeding 20 tonnes.

truck (type 2) means a truck that has:

- (a) 2 axles and an MRC exceeding 12 tonnes, or
- (b) 3 axles and an MRC exceeding 16.5 tonnes, or
- (c) 4 or more axles and an MRC exceeding 20 tonnes.

twinsteer axle group means a group of 2 axles.

- (2) Any term or expression used in this Schedule that is defined for the purposes of Schedule 2 to the Act has the same meaning in this Schedule as it has in that Part

unless it is otherwise defined in this Schedule.

2 Close-spaced axles

- (1) For the purposes of this Schedule (other than the definitions of **single axle group**, **tandem axle group**, **twinsteer axle group**, **tri-axle group** and **quad-axle group** in clause 1):
 - (a) 2 axles less than one metre apart are to be regarded as one axle, and
 - (b) 3 axles not more than 2 metres apart are to be regarded as 2 axles, and
 - (c) 4 axles not more than 3.2 metres apart are to be regarded as 3 axles.
- (2) A reference to a distance in subclause (1) is a reference to the horizontal distance between the centre-lines of:
 - (a) in the case of subclause (1) (a), the 2 axles, and
 - (b) in any other case, the outermost axles.

3 Determination of number of trailers

For the purposes of determining the number of trailers that a prime mover or truck is nominated to haul:

- (a) a converter dolly and a semi trailer when used together are to be regarded as one trailer, and
- (b) a low loader dolly and a low loader when used together are to be regarded as one trailer.

Note—

Nothing in this clause affects the requirement under another Part of this Schedule that a separate annual registration fee be paid for each converter dolly or low loader dolly and for each semi trailer.

4 Special purpose vehicle

- (1) In this Schedule, **special purpose vehicle** means:
 - (a) a vehicle (other than a caravan, a mobile home, a mobile library, a mobile workshop, a mobile laboratory or a mobile billboard) where the primary purpose for which it was built, or permanently modified, was not the carriage of goods or passengers, or
 - (b) any of the following vehicles:
 - (i) a forklift,
 - (ii) a straddle carrier,

(iii) a mobile cherry picker,

(iv) a mobile crane.

(2) The term **goods** in subclause (1) (a) does not include fuel, water, lubricants, tools and any other equipment or accessories necessary for the normal operation of the vehicle.

5 Chargeable heavy vehicles in 2 or more categories

If a chargeable heavy vehicle falls within 2 or more categories or types of vehicle that are relevant for the purposes of determining a registration charge under this Schedule, the charge for the vehicle is the higher or highest of the charges that could apply to the vehicle.

Part 2 Annual registration charges for 2009–2010 financial year

6 Amount of annual registration charge for 2009–2010 financial year

The annual registration charge for a chargeable heavy vehicle that is registered, or the registration of which is renewed, during the 2009–2010 financial year is:

- (a) if the vehicle is a truck or prime mover—the relevant amount (having regard to the number of axles of the vehicle) set out in Column 2, 3, 4 or 5 of Table 1 to this clause opposite the type of truck or prime mover concerned as specified in Column 1 of the Table, or
- (b) if the vehicle is a trailer—the relevant amount (having regard to the axles or axle group of the trailer) set out in Column 2, 3 or 4, or calculated in accordance with Column 5, of Table 2 to this clause opposite the type of trailer concerned as specified in Column 1 of the Table, or
- (c) if the vehicle is a bus—the relevant amount set out in Column 2, 3 or 4 of Table 3 to this clause (having regard to the number of axles of the vehicle) opposite the type of bus concerned as specified in Column 1 of the Table, or
- (d) if the vehicle is a special purpose vehicle—the amount (if any) specified by, or calculated in accordance with, Column 2 of Table 4 to this clause opposite the type of vehicle concerned as specified in Column 1 of the Table.

Table 1—Load carrying vehicles

Column 1	Column 2	Column 3	Column 4	Column 5
Vehicle type	2 axles	3 axles	4 axles	5 or more axles
Trucks				
Truck (type 1)	\$392	\$673	\$673	\$673
Truck (type 2)	\$673	\$886	\$886	\$886

Short combination truck	\$673	\$886	\$1,644	\$1,644
Medium combination truck	\$6,014	\$6,014	\$6,496	\$6,496
Long combination truck	\$8,293	\$8,293	\$8,293	\$8,293

Prime movers

Short combination prime mover	\$1,032	\$4,056	\$4,460	\$4,460
Multi-combination prime mover	\$7,276	\$7,276	\$8,003	\$8,003

Table 2—Load carrying trailers

Column 1	Column 2	Column 3	Column 4	Column 5
Trailer type	Single axle	Tandem axle group	Tri-axle axle group	Quad-axle group and above
Pig trailer	\$392	\$784	\$1,176	An amount in dollars calculated using the formula: 392 × Number of axles
Dog trailer	n/a	\$784	\$1,176	An amount in dollars calculated using the formula: 392 × Number of axles
Semi trailer	\$392	\$784	\$1,254	An amount in dollars calculated using the formula: 418 × Number of axles
B-double lead trailer and B-triple lead and middle trailers	\$392	\$2,352	\$3,684	An amount in dollars calculated using the formula: 1,228 × Number of axles

Converter dolly or low dolly	\$392	\$784	\$1,176	An amount in dollars calculated using the formula: 392 × Number of axles
------------------------------	-------	-------	---------	---

Table 3—Buses

Column 1	Column 2	Column 3	Column 4
Bus type	2 axles	3 axles	4 or more axles
Bus (type 1)	\$392	n/a	n/a
Bus (type 2)	\$392	\$2,154	\$2,154
Articulated bus	n/a	\$392	\$392

Table 4—Special purpose vehicles

Column 1	Column 2
Type of vehicle	Amount or formula for amount
Special purpose vehicle (type P)	No charge
Special purpose vehicle (type T)	\$256
Special purpose vehicle (type O)	An amount in dollars calculated using the formula: 320 + (320 × Number of axles over 2)

Part 3 Annual registration charges for 2010-2011 financial year

7 Amount of annual registration charge for 2010-2011 financial year

The annual registration charge for a chargeable heavy vehicle that is registered, or the registration of which is renewed, during the 2010-2011 financial year is:

- if the vehicle is a truck or prime mover—the relevant amount (having regard to the number of axles of the vehicle) set out in Column 2, 3, 4 or 5 of Table 1 to this clause opposite the type of truck or prime mover concerned as specified in Column 1 of the Table, or
- if the vehicle is a trailer—the relevant amount (having regard to the axles or axle group of the trailer) set out in Column 2, 3 or 4, or calculated in accordance with Column 5, of Table 2 to this clause opposite the type of trailer concerned as specified in Column 1 of the Table, or
- if the vehicle is a bus—the relevant amount set out in Column 2, 3 or 4 of Table 3 to this clause (having regard to the number of axles of the vehicle) opposite the type of bus concerned as specified in Column 1 of the Table, or
- if the vehicle is a special purpose vehicle—the amount (if any) specified by, or

calculated in accordance with, Column 2 of Table 4 to this clause opposite the type of vehicle concerned as specified in Column 1 of the Table.

Table 1—Load carrying vehicles

Column 1	Column 2	Column 3	Column 4	Column 5
Vehicle type	2 axles	3 axles	4 axles	5 or more axles
Trucks				
Truck (type 1)	\$408	\$701	\$701	\$701
Truck (type 2)	\$701	\$923	\$923	\$923
Short combination truck	\$701	\$923	\$1,713	\$1,713
Medium combination truck	\$6,267	\$6,267	\$6,769	\$6,769
Long combination truck	\$8,641	\$8,641	\$8,641	\$8,641
Prime movers				
Short combination prime mover	\$1,075	\$4,226	\$4,647	\$4,647
Multi-combination prime mover	\$7,582	\$7,582	\$8,339	\$8,339

Table 2—Load carrying trailers

Column 1	Column 2	Column 3	Column 4	Column 5
Trailer type	Single axle	Tandem axle group	Tri-axle axle group	Quad-axle group and above
Pig trailer	\$408	\$816	\$1,224	An amount in dollars calculated using the formula: 408 × Number of axles
Dog trailer	n/a	\$816	\$1,224	An amount in dollars calculated using the formula: 408 × Number of axles

Semi trailer	\$408	\$816	\$1,386	An amount in dollars calculated using the formula: 462 × Number of axles
B-double lead trailer and B-triple lead and middle trailers	\$408	\$4,034	\$6,372	An amount in dollars calculated using the formula: 2,124 × Number of axles
Converter dolly or low dolly	\$408	\$816	\$1,224	An amount in dollars calculated using the formula: 408 × Number of axles

Table 3—Buses

Column 1	Column 2	Column 3	Column 4
Bus type	2 axles	3 axles	4 or more axles
Bus (type 1)	\$408	n/a	n/a
Bus (type 2)	\$408	\$2,244	\$2,244
Articulated bus	n/a	\$408	\$408

Table 4—Special purpose vehicles

Column 1	Column 2
Type of vehicle	Amount or formula for amount
Special purpose vehicle (type P)	No charge
Special purpose vehicle (type T)	\$267
Special purpose vehicle (type O)	An amount in dollars calculated using the formula: 333 + (333 × Number of axles over 2)

Part 4 Annual registration charges for 2011-2012 financial year

8 Amount of annual registration charge for 2011-2012 financial year

The annual registration charge for a chargeable heavy vehicle that is registered, or the registration of which is renewed, during the 2011-2012 financial year is:

- (a) if the vehicle is a truck or prime mover—the relevant amount (having regard to the number of axles of the vehicle) set out in Column 2, 3, 4 or 5 of Table 1 to this clause opposite the type of truck or prime mover concerned as specified in Column 1 of the Table, or

- (b) if the vehicle is a trailer—the relevant amount (having regard to the axles or axle group of the trailer) set out in Column 2, 3 or 4, or calculated in accordance with Column 5, of Table 2 to this clause opposite the type of trailer concerned as specified in Column 1 of the Table, or
- (c) if the vehicle is a bus—the relevant amount set out in Column 2, 3 or 4 of Table 3 to this clause (having regard to the number of axles of the vehicle) opposite the type of bus concerned as specified in Column 1 of the Table, or
- (d) if the vehicle is a special purpose vehicle—the amount (if any) specified by, or calculated in accordance with, Column 2 of Table 4 to this clause opposite the type of vehicle concerned as specified in Column 1 of the Table.

Table 1—Load carrying vehicles

Column 1	Column 2	Column 3	Column 4	Column 5
Vehicle type	2 axles	3 axles	4 axles	5 or more axles
Trucks				
Truck (type 1)	\$418	\$718	\$718	\$718
Truck (type 2)	\$718	\$945	\$945	\$945
Short combination truck	\$718	\$945	\$1,754	\$1,754
Medium combination truck	\$6,417	\$6,417	\$6,931	\$6,931
Long combination truck	\$8,848	\$8,848	\$8,848	\$8,848
Prime movers				
Short combination prime mover	\$1,101	\$4,327	\$4,759	\$4,759
Multi-combination prime mover	\$7,764	\$7,764	\$8,539	\$8,539

Table 2—Load carrying trailers

Column 1	Column 2	Column 3	Column 4	Column 5
Trailer type	Single axle	Tandem axle group	Tri-axle axle group	Quad-axle group and above

Pig trailer	\$418	\$836	\$1,254	An amount in dollars calculated using the formula: 418 × Number of axles
Dog trailer	n/a	\$836	\$1,254	An amount in dollars calculated using the formula: 418 × Number of axles
Semi trailer	\$418	\$836	\$1,419	An amount in dollars calculated using the formula: 473 × Number of axles
B-double lead trailer and B-triple lead and middle trailers	\$418	\$4,130	\$6,525	An amount in dollars calculated using the formula: 2,175 × Number of axles
Converter dolly or low dolly	\$418	\$836	\$1,254	An amount in dollars calculated using the formula: 418 × Number of axles

Table 3—Buses

Column 1	Column 2	Column 3	Column 4
Bus type	2 axles	3 axles	4 or more axles
Bus (type 1)	\$418	n/a	n/a
Bus (type 2)	\$418	\$2,298	\$2,298
Articulated bus	n/a	\$418	\$418

Table 4—Special purpose vehicles

Column 1	Column 2
Type of vehicle	Amount or formula for amount
Special purpose vehicle (type P)	No charge
Special purpose vehicle (type T)	\$273
Special purpose vehicle (type O)	An amount in dollars calculated using the formula: 341 + (341 × Number of axles over 2)

Part 5 Annual registration charges for 2012–2013 financial year

9 Amount of annual registration charge for 2012–2013 financial year

The annual registration charge for a chargeable heavy vehicle that is registered, or the registration of which is renewed, during the 2012–2013 financial year is:

- (a) if the vehicle is a truck or prime mover—the relevant amount (having regard to the number of axles of the vehicle) set out in Column 2, 3, 4 or 5 of Table 1 to this clause opposite the type of truck or prime mover concerned as specified in Column 1 of the Table, or
- (b) if the vehicle is a trailer—the relevant amount (having regard to the axles or axle group of the trailer) set out in Column 2, 3 or 4, or calculated in accordance with Column 5, of Table 2 to this clause opposite the type of trailer concerned as specified in Column 1 of the Table, or
- (c) if the vehicle is a bus—the relevant amount set out in Column 2, 3 or 4 of Table 3 to this clause (having regard to the number of axles of the vehicle) opposite the type of bus concerned as specified in Column 1 of the Table, or
- (d) if the vehicle is a special purpose vehicle—the amount (if any) specified by, or calculated in accordance with, Column 2 of Table 4 to this clause opposite the type of vehicle concerned as specified in Column 1 of the Table.

Table 1—Load carrying vehicles

Column 1	Column 2	Column 3	Column 4	Column 5
Vehicle type	2 axles	3 axles	4 axles	5 or more axles
Trucks				
Truck (type 1)	\$542	\$859	\$759	\$759
Truck (type 2)	\$859	\$1,021	\$1,021	\$1,021
Short combination truck	\$859	\$1,021	\$1,854	\$1,854
Medium combination truck	\$6,783	\$6,783	\$7,326	\$7,326
Long combination truck	\$9,361	\$9,361	\$9,361	\$9,361
Prime movers				
Short combination prime mover	\$1,164	\$4,744	\$5,030	\$5,030

Multi-combination prime mover

\$9,457

\$9,457

\$10,402

\$10,402

Table 2—Load carrying trailers

Column 1	Column 2	Column 3	Column 4	Column 5
Trailer type	Single axle	Tandem axle group	Tri-axle axle group	Quad-axle group and above
Pig trailer	\$550	\$1,100	\$1,650	An amount in dollars calculated using the formula: 550 × Number of axles
Dog trailer	n/a	\$1,100	\$1,650	An amount in dollars calculated using the formula: 550 × Number of axles
Semi trailer	\$550	\$1,100	\$1,650	An amount in dollars calculated using the formula: 550 × Number of axles
B-double lead trailer and B-triple lead and middle trailers	\$550	\$2,100	\$3,300	An amount in dollars calculated using the formula: 1,100 × Number of axles
Converter dolly or low loader dolly	\$550	\$1,100	\$1,650	An amount in dollars calculated using the formula: 550 × Number of axles

Table 3—Buses

Column 1	Column 2	Column 3	Column 4
Bus type	2 axles	3 axles	4 or more axles
Bus (type 1)	\$488	n/a	n/a
Bus (type 2)	\$488	\$2,429	\$2,429
Articulated bus	n/a	\$488	\$488

Table 4—Special purpose vehicles

Column 1	Column 2
Type of vehicle	Amount or formula for amount
Special purpose vehicle (type P)	No charge
Special purpose vehicle (type T)	\$292
Special purpose vehicle (type O)	An amount in dollars calculated using the formula: $365 + (365 \times \text{Number of axles over } 2)$

Part 6 Annual registration charges for 2013–2014 financial year

10 Amount of annual registration charge for 2013–2014 financial year

The annual registration charge for a chargeable heavy vehicle that is registered, or the registration of which is renewed, during the 2013–2014 financial year is:

- if the vehicle is a truck or prime mover—the relevant amount (having regard to the number of axles of the vehicle) set out in Column 2, 3, 4 or 5 of Table 1 to this clause opposite the type of truck or prime mover concerned as specified in Column 1 of the Table, or
- if the vehicle is a trailer—the relevant amount (having regard to the axles or axle group of the trailer) set out in Column 2, 3 or 4, or calculated in accordance with Column 5, of Table 2 to this clause opposite the type of trailer concerned as specified in Column 1 of the Table, or
- if the vehicle is a bus—the relevant amount set out in Column 2, 3 or 4 of Table 3 to this clause (having regard to the number of axles of the vehicle) opposite the type of bus concerned as specified in Column 1 of the Table, or
- if the vehicle is a special purpose vehicle—the amount (if any) specified by, or calculated in accordance with, Column 2 of Table 4 to this clause opposite the type of vehicle concerned as specified in Column 1 of the Table.

Table 1—Load carrying vehicles

Column 1	Column 2	Column 3	Column 4	Column 5
Vehicle type	2 axles	3 axles	4 axles	5 or more axles
Trucks				
Truck (type 1)	\$556	\$880	\$778	\$778
Truck (type 2)	\$880	\$1,047	\$1,047	\$1,047
Short combination truck	\$880	\$1,047	\$1,900	\$1,900

Medium combination truck	\$6,953	\$6,953	\$7,509	\$7,509
--------------------------	---------	---------	---------	---------

Long combination truck	\$9,595	\$9,595	\$9,595	\$9,595
------------------------	---------	---------	---------	---------

Prime movers

Short combination prime mover	\$1,193	\$4,863	\$5,156	\$5,156
-------------------------------	---------	---------	---------	---------

Multi-combination prime mover	\$9,693	\$9,693	\$10,662	\$10,662
-------------------------------	---------	---------	----------	----------

Table 2—Load carrying trailers

Column 1	Column 2	Column 3	Column 4	Column 5
Trailer type	Single axle	Tandem axle group	Tri-axle axle group	Quad-axle group and above
Pig trailer	\$564	\$1,128	\$1,692	An amount in dollars calculated using the formula: 564 × Number of axles
Dog trailer	n/a	\$1,128	\$1,692	An amount in dollars calculated using the formula: 564 × Number of axles
Semi trailer	\$564	\$1,128	\$1,692	An amount in dollars calculated using the formula: 564 × Number of axles
B-double lead trailer and B-triple lead and middle trailers	\$564	\$2,152	\$3,384	An amount in dollars calculated using the formula: 1,128 × Number of axles
Converter dolly or low loader dolly	\$564	\$1,128	\$1,692	An amount in dollars calculated using the formula: 564 × Number of axles

Table 3—Buses

Column 1	Column 2	Column 3	Column 4
Bus type	2 axles	3 axles	4 or more axles
Bus (type 1)	\$500	n/a	n/a
Bus (type 2)	\$500	\$2,490	\$2,490
Articulated bus	n/a	\$500	\$500

Table 4—Special purpose vehicles

Column 1	Column 2
Type of vehicle	Amount or formula for amount
Special purpose vehicle (type P)	No charge
Special purpose vehicle (type T)	\$299
Special purpose vehicle (type O)	An amount in dollars calculated using the formula: $374 + (374 \times \text{Number of axles over 2})$

Part 7 Annual registration charges commencing with 2014-2015 financial year

11 Amount of annual registration charge commencing with 2014-2015 financial year

- (1) The annual registration charge for a chargeable heavy vehicle that is registered, or the registration of which is renewed, during the 2014-2015 financial year is:
 - (a) if the vehicle is a truck or prime mover—the relevant amount (having regard to the number of axles of the vehicle) set out in Column 2, 3, 4 or 5 of Table 1 to this clause opposite the type of truck or prime mover concerned as specified in Column 1 of the Table, or
 - (b) if the vehicle is a trailer—the relevant amount (having regard to the axles or axle group of the trailer) set out in Column 2, 3 or 4, or calculated in accordance with Column 5, of Table 2 to this clause opposite the type of trailer concerned as specified in Column 1 of the Table, or
 - (c) if the vehicle is a bus—the relevant amount (having regard to the number of axles of the bus) set out in Column 2, 3 or 4 of Table 3 to this clause opposite the type of bus concerned as specified in Column 1 of the Table, or
 - (d) if the vehicle is a special purpose vehicle—the amount (if any) specified by, or calculated in accordance with, Column 2 of Table 4 to this clause opposite the type of vehicle concerned as specified in Column 1 of the Table.
- (2) The annual registration charge for a chargeable heavy vehicle that is registered, or

the registration of which is renewed, during the 2014–2015 financial year continues to apply for each subsequent financial year unless another provision of this Schedule provides otherwise.

Table 1—Load carrying vehicles

Column 1	Column 2	Column 3	Column 4	Column 5
Vehicle type	2 axles	3 axles	4 axles	5 or more axles
Trucks				
Truck (type 1)	\$563	\$891	\$788	\$788
Truck (type 2)	\$891	\$1,061	\$1,061	\$1,061
Short combination truck	\$891	\$1,061	\$1,925	\$1,925
Medium combination truck	\$7,043	\$7,043	\$7,607	\$7,607
Long combination truck	\$9,720	\$9,720	\$9,720	\$9,720
Prime movers				
Short combination prime mover	\$1,209	\$4,926	\$5,223	\$5,223
Multi-combination prime mover	\$9,819	\$9,819	\$10,801	\$10,801

Table 2—Load carrying trailers

Column 1	Column 2	Column 3	Column 4	Column 5
Trailer type	Single axle	Tandem axle group	Tri-axle axle group	Quad-axle group and above
Pig trailer	\$571	\$1,142	\$1,713	An amount in dollars calculated using the formula: 571 × Number of axles
Dog trailer	n/a	\$1,142	\$1,713	An amount in dollars calculated using the formula: 571 × Number of axles

Semi trailer	\$571	\$1,142	\$1,713	An amount in dollars calculated using the formula: 571 × Number of axles
B-double lead trailer and B-triple lead and middle trailers	\$571	\$2,180	\$3,429	An amount in dollars calculated using the formula: 1,143 × Number of axles
Converter dolly or low loader dolly	\$571	\$1,142	\$1,713	An amount in dollars calculated using the formula: 571 × Number of axles

Table 3—Buses

Column 1	Column 2	Column 3	Column 4
Bus type	2 axles	3 axles	4 or more axles
Bus (type 1)	\$507	n/a	n/a
Bus (type 2)	\$507	\$2,522	\$2,522
Articulated bus	n/a	\$507	\$507

Table 4—Special purpose vehicles

Column 1	Column 2
Type of vehicle	Amount or formula for amount
Special purpose vehicle (type P)	No charge
Special purpose vehicle (type T)	\$303
Special purpose vehicle (type O)	An amount in dollars calculated using the formula: 379 + (379 × Number of axles over 2)

Dictionary

Administrator of Vehicle Standards means the Administrator of Vehicle Standards referred to in section 22 of the *Motor Vehicle Standards Act 1989* of the Commonwealth.

adopted standard—see clause 18 of Schedule 2.

ADR (Australian Design Rule) means a national standard under the *Motor Vehicle Standards Act 1989* of the Commonwealth as in force from time to time.

air brake means an air-operated or air-assisted brake.

air brake test pressure, in relation to the brake system of a vehicle, means half of the sum of the cut-in and cut-out pressures of the air compressor of that brake system, as shown by specification of the manufacturer of that brake system or vehicle.

alternative headlight means a light which is lighted in the place of a headlight by a dipping device.

applicable fee, in relation to a matter, means a fee set, fixed or prescribed by or under this Regulation in relation to the matter.

applicable vehicle standard—see clause 51.

articulated bus means a bus:

- (a) consisting of at least 2 rigid sections with access between the sections for passengers, and
- (b) the sections of which are connected to each other so as to allow rotary movement between the sections.

articulated vehicle means a motor vehicle having at its rear a portion, on wheels, which is pivoted to, and a part of which (not being a pole, drawbar or similar device or an accessory of the motor vehicle) is superimposed upon, the forward portion of the vehicle.

Australian Motor Vehicle Certification Board means the body:

- (a) known under that name,
- (b) consisting of representatives of the Commonwealth, each of the States and Territories, and
- (c) having, as one of its objectives, to ensure that vehicles supplied for use in, manufactured in, or imported into, Australia are designed and manufactured so as to:
 - (i) comply with the requirements of Australian Design Rules, or
 - (ii) provide a level of safety that is equivalent to that provided by Australian Design Rules.

Australian Road Rules means that part of the publication known as the [Australian Road Rules](#), ISBN 0 7240 8874 1, published by the National Road Transport Commission on 19 October 1999 that comprises the road rules approved by the Australian Transport Council under the [National Road Transport Commission Act 1991](#) of the Commonwealth on 29 January 1999 (together with the amendments to those rules approved by the Council on 30 June 1999 and 11 October 1999).

authorised examiner means a person authorised to carry out any function under clause 58.

authorised inspection station means premises that a person is authorised to use under clause 59.

authorised person means a person authorised by the Authority to be an authorised person for the purposes of this Regulation.

authorised proprietor means a person authorised under clause 59.

Authority standard compliance specifications means any specifications that the Authority, by

order published in the Gazette, has declared to be specifications the compliance with which will be taken to be compliance with the applicable vehicle standards for the purposes of clause 55A or 76AD.

auxiliary number-plate means a number-plate referred to in clause 21.

axle means one or more shafts positioned in a line across a vehicle, on which one or more wheels intended to support the vehicle turn.

axle group means a single axle group, tandem axle group, twinsteer axle group, tri-axle group or quad-axle group.

B-double means a combination consisting of a prime mover towing 2 semi-trailers.

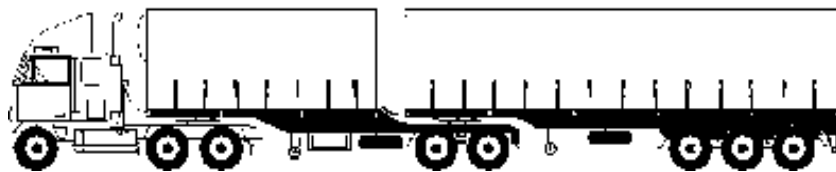

B-double

brake means a device for retarding or controlling the rotation of the wheels of a vehicle and for bringing the vehicle to a stop.

braking system means all the brakes of a vehicle and all the components of the mechanisms by which they are operated.

British Standard means a standard approved for publication on behalf of the British Standards Institution.

British Standards Institution means the institution of that name established under Royal Charter.

bus means a motor vehicle built mainly to carry people that seats over 9 adults (including the driver).

car means a motor vehicle built mainly to carry people that:

- (a) seats not over 9 adults (including the driver), and
- (b) has a body commonly known as a sedan, station wagon, coupe, convertible, or roadster, and
- (c) has 3 or more wheels.

car derivative means a motor vehicle:

- (a) that is of the kind known as a utility, station wagon or panel van, and
- (b) that is of the same make as a factory produced car, and
- (c) in which that part of the body form that is forward of the windscreen and the greater part of the mechanical equipment are the same or substantially the same as in a factory produced car.

centre line, of an axle group, means:

- (a) if the group consists of 2 axles, one of which is fitted with twice the number of tyres as the other

axle—a line located one third of the way from the centre line of the axle with fewer tyres, and

(b) in any other case—a line located midway between the centre lines of the outermost axles of the group.

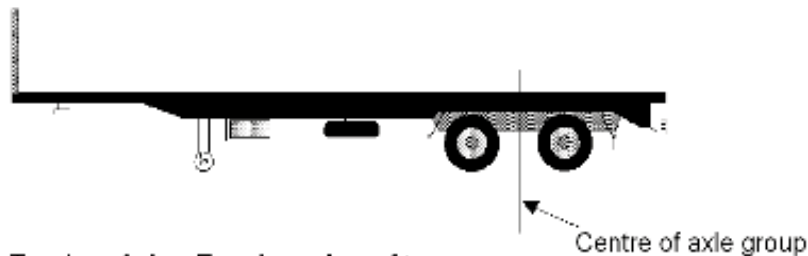

Tandem Axle - Equal number of tyres
Centre line of a tandem axle group fitted with an equal number of tyres on each axle

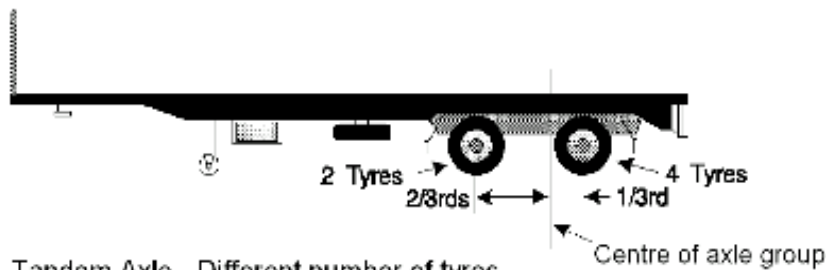

Tandem Axle - Different number of tyres
Centre line of a tandem axle group fitted with a different number of tyres on each axle

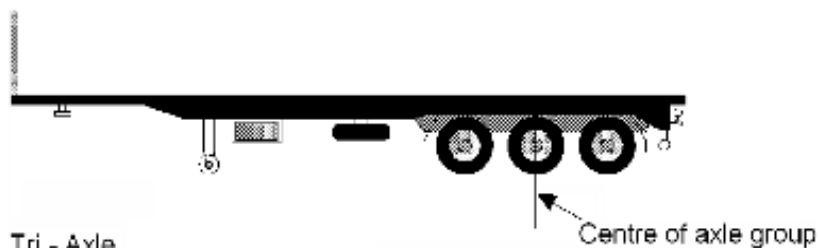

Tri - Axle
Centre line of a tri-axle group

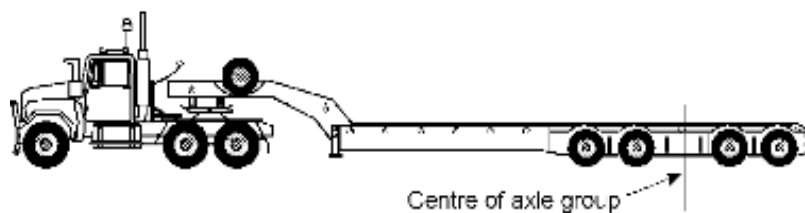

Quad - Axle
Centre line of a quad-axle group

certificate of approved operations means a certificate issued in respect of a registrable vehicle in accordance with clause 55.

clearance light means a light which, when lighted, provides an indication of the width of a vehicle together with any loading or equipment on it either from the front or from the rear of the vehicle, as the case may be.

combination means a group of vehicles consisting of a motor vehicle connected to 1 or more

vehicles.

controlled access bus means a bus, except an articulated bus, that is more than 12.5 metres long.

converter dolly means a trailer with one axle group or single axle and a fifth wheel coupling, designed to convert a semi-trailer into a dog trailer.

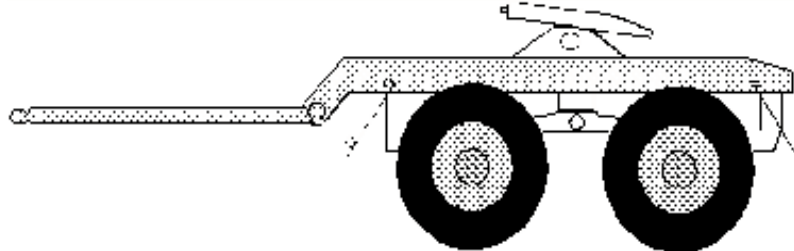

Converter dolly

corporation means a corporation recognised under the laws of Australia, including a foreign corporation and a body incorporated by or under statute.

daylight means the period in a day from sunrise to sunset.

dealer, in relation to a vehicle, means the holder of a dealer's licence under the [Motor Dealers Act 1974](#).

dipping device means a device by which the driver of a motor vehicle, while retaining his or her normal driving position:

- (a) can cause the main beam of light projected by each of the headlights of a motor vehicle which has 2 headlights or by the headlight of a motor vehicle which has one headlight to be dipped, or
- (b) can extinguish each of the headlights of a motor vehicle which has 2 headlights or the headlight of a motor vehicle which has one headlight, and simultaneously light 2 alternative headlights or one alternative headlight (as the case may be), or
- (c) can extinguish each set of headlights where a motor vehicle has 4 headlights, in sets of 2, and simultaneously light one light in each set.

dog trailer means a trailer (including a trailer consisting of a semi-trailer and converter dolly) with:

- (a) one axle group or single axle at the front that is steered by connection to the towing vehicle by a drawbar, and
- (b) one axle group or single axle at the rear.

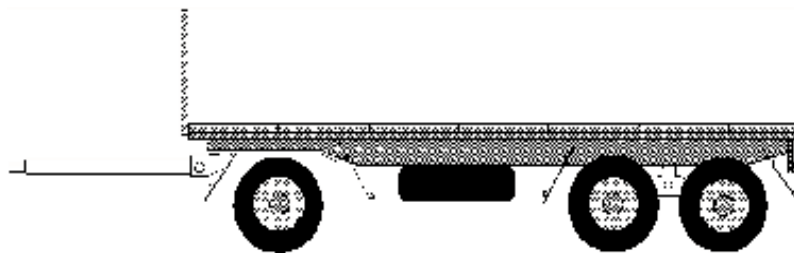

Dog trailer

drawbar means a part of a trailer (other than a semi-trailer) that connects the trailer body to a coupling for towing purposes.

drawbar length, in relation to a trailer, means the horizontal distance from the centre line of the towing pivot to the centre line of the foremost axle group of the trailer.

drive includes be in control of.

driver, of a vehicle, means the person driving the vehicle.

duty legislation means the provisions of the [Stamp Duties Act 1920](#) and the [Duties Act 1997](#) relating to the payment of duty on the registration or transfer of registration of a motor vehicle, trailer or other registrable vehicle.

D-value means the strength capacity of a connection device as defined in:

- (a) Australian/New Zealand Standard AS/NZS 4968.1:2003 *Heavy-road vehicles—Mechanical coupling between articulated vehicle combinations—Design criteria and selection requirements for fifth wheel, kingpin and associated equipment*, or
- (b) Australian Standard AS 2213.1-2001/Amdt 1-2002 *Commercial road vehicles—Mechanical connections between towing vehicles—Selection and marking of pin-type couplings and drawbar eyes*.

Economic Commission for Europe means the United Nations Economic Commission for Europe.

effective range means the distance at which a light, when lighted, will illuminate and render easily discernible under normal atmospheric conditions between sunset and sunrise any person dressed in dark clothing, or any substantial dark object, in front of the vehicle to which the light is affixed.

eligible pensioner has the same meaning as it has in the [Motor Vehicles Taxation Act 1988](#).

eligible vehicle means a vehicle that is eligible for registration in accordance with clause 6.

emergency brake means a brake designed to be used if a service brake fails.

emergency vehicle means a vehicle driven by a person who is:

- (a) a police officer acting in the course of his or her duties as a police officer, or
- (b) a member of the Ambulance Service rendering or providing transport for sick or injured persons, or
- (c) a member of a fire brigade or rural fire brigade providing transport in the course of an emergency, or
- (c1) a member of the State Emergency Service providing transport in the course of an emergency, or
- (d) a person (or person belonging to a class of persons) approved by the Authority.

examiner's authority means an authority in force under clause 58.

fifth wheel coupling means a device, other than the upper rotating element and the kingpin (which are parts of a semi-trailer), used with a prime mover, semi-trailer or a converter dolly to permit quick

coupling and uncoupling and to provide for articulation.

forfeited vehicle means a registrable vehicle that is the subject of a forfeiture order of the Local Court made under section 79 of the Act.

front fog light means a light used to improve the illumination of the road in case of fog, snowfall, heavy rain or a dust storm.

glazing means material fitted to the front, sides, rear or interior of a vehicle, through which the driver or a passenger can obtain a view of the road, but does not include a coating added after manufacture of the material.

ground clearance means the minimum distance to the ground from the underside of a vehicle excluding its tyres, wheels, wheel hubs, brake backing plates and flexible mudguards or mudflaps.

GTM (gross trailer mass) means the mass transmitted to the ground by the axles of a trailer when the trailer is loaded to its GVM and connected to a towing vehicle.

hauling unit means a rigid vehicle or prime mover.

Heavy Vehicle National Law means:

(a) the Heavy Vehicle National Law:

- (i) as in force from time to time, set out in the Schedule to the *Heavy Vehicle National Law Act 2012* of Queensland, and
- (ii) as it applies as a law of New South Wales or another State or a Territory, or

(b) the law of another State or a Territory that substantially corresponds to the law referred to in paragraph (a).

Note—

In relation to the *Heavy Vehicle National Law (NSW)*, see section 4 (Application of Heavy Vehicle National Law) of the *Heavy Vehicle (Adoption of National Law) Act 2013*.

high-beam, in relation to a headlight or front fog light fitted to a vehicle, means that the light is built or adjusted so that when the vehicle is standing on level ground, the top of the main beam of light projected is above the low-beam position.

hire trailer means a trailer that is hired for a fee or other consideration.

identification plate means a plate authorised to be placed on a vehicle, or taken to have been placed on a vehicle, under the *Motor Vehicle Standards Act 1989* of the Commonwealth.

implement means a motor vehicle which comprises an excavator, road grader, road roller, bulldozer, forklift truck or other machinery or apparatus and is not constructed on a chassis of a type normally used in the construction of a motor lorry.

inspect, in relation to a registrable vehicle, includes observe the vehicle's performance, with or without the use of instrumentation.

inspection report, in relation to a registrable vehicle, means an inspection report issued under clause 58 for the vehicle.

jurisdiction means a State, the Australian Capital Territory or the Northern Territory, as the case requires.

left, in relation to a vehicle, means to the left of the centre of the vehicle when viewed by a person in the vehicle and facing towards the front of the vehicle.

light vehicle means a registrable vehicle that is not a heavy vehicle.

load-sharing suspension system means an axle group suspension system that:

- (a) is built to divide the load between the tyres on the group so that no tyre carries a mass more than 10% greater than the mass it would carry if the load were divided equally, and
- (b) has effective damping characteristics on all axles of the group.

lost, in relation to a number-plate, includes mislaid or unable to be found for any reason.

low-beam, in relation to a headlight or front fog light fitted to a vehicle, means that the light is built or adjusted so that, when the vehicle is standing on level ground, the top of the main beam of light projected is:

- (a) not higher than the centre of the headlight or fog light, when measured at a point 8 metres in front of the vehicle, and
- (b) not more than one metre higher than the level on which the vehicle is standing, when measured at a point 25 metres in front of the vehicle.

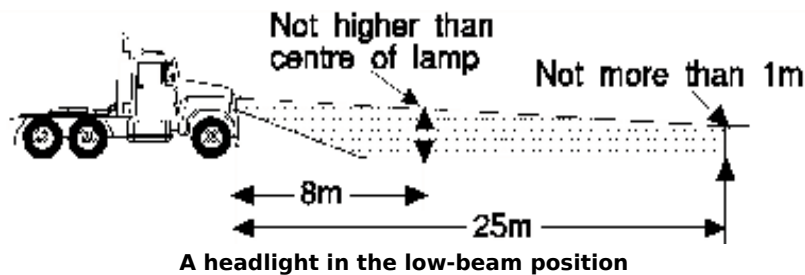

low loader means a gooseneck semi-trailer with a loading deck no more than 1 metre above the ground.

major vehicle defect notice—see clause 70 (1) (a).

minor vehicle defect notice—see clause 70 (1) (b).

moped means a motor bike or trike with an engine cylinder capacity of not over 50 millilitres and a maximum speed of not over 50 kilometres an hour.

motor bike means a motor vehicle with 2 wheels, and includes a 2 wheeled motor vehicle with a sidecar attached to it that is supported by a third wheel.

motor lorry means any motor vehicle (whether or not in combination with any trailer) that is

constructed principally for the conveyance of goods or merchandise or for the conveyance of any kind of materials used in any trade, business or industry, or for use in any work whatsoever other than the conveyance of persons, but does not include a motor bike or a tractor.

motor registry means a place at which registration of a registrable vehicle can be effected by or on behalf of the Authority.

motor trike means a motor vehicle with 3 wheels, but does not include a 2 wheeled motor vehicle with a sidecar attached to it that is supported by a third wheel.

motor vehicle combination means a hauling unit with one or more trailers attached.

mudguard means a fitting or device, with or without a mudflap, which is built and fitted to a vehicle in a way that will, as far as practicable, catch or deflect downwards any stone, mud, water or other substance thrown up by the rotation of the wheel for which the fitting or device is provided.

national maintenance management accreditation means maintenance management accreditation within the meaning of the [Heavy Vehicle National Law \(NSW\)](#).

national standard means a national standard under the [Motor Vehicle Standards Act 1989](#) of the Commonwealth.

nominated configuration means the configuration in which a registrable vehicle will operate for the registration period, as nominated by the registered operator.

non-national maintenance management accreditation scheme means a scheme for maintenance management accreditation other than national maintenance management accreditation.

operations plate means a plate installed on a registrable vehicle in accordance with clause 55 (2).

owner, in relation to a vehicle, means:

- (a) a person in whose name the vehicle is registered under a Commonwealth, State or Territory Act, or
- (b) a person who, according to the vehicle registration authority's records, has acquired the vehicle from the person in whose name the vehicle is registered under the relevant Act, or
- (c) if the vehicle is not registered—a person to whom a mark, plate or permit has been issued to allow the vehicle to be used, or
- (d) a person who is entitled to the possession of the vehicle.

personally imported vehicle means a vehicle that is imported into Australia by a person who:

- (a) owned and used the vehicle for the period determined in accordance with the [Motor Vehicle Standards Act 1989](#) of the Commonwealth before it was imported into Australia, and
- (b) when the vehicle was imported into Australia, was:
 - (i) an Australian citizen or permanent resident or a person who had applied to become an Australian citizen or permanent resident, and
 - (ii) old enough to hold a licence or permit to drive the vehicle, and

- (c) within the previous 12 months, had not imported into Australia another vehicle owned by the person.

plate holder—see clause 17.

point of articulation means:

- (a) the axis of a kingpin for a fifth wheel, or
- (b) the vertical axis of rotation of a fifth wheel coupling, or
- (c) the vertical axis of rotation of a turntable assembly, or
- (d) the vertical axis of rotation of the front axle group or single axle of a dog trailer, or
- (e) the coupling pivot point of a semi-trailer.

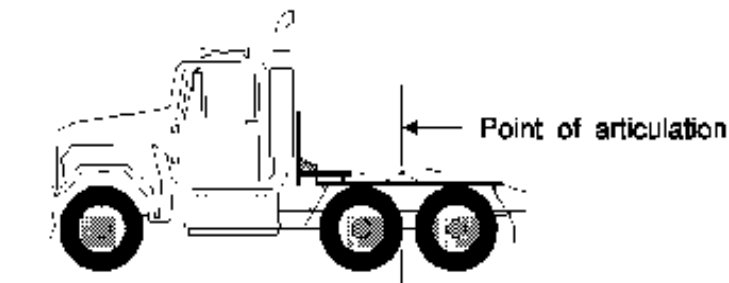

Point of articulation—fifth wheel on a prime mover



Point of articulation—kingpin for fifth wheel

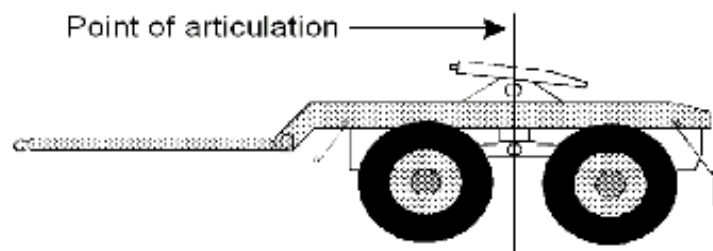

Point of articulation—fifth wheel coupling on a converter dolly (forming the front axle group of a dog trailer)

pole-type trailer means a trailer that:

- (a) is attached to a towing vehicle by means of a pole or an attachment fitted to the pole, and
- (b) is ordinarily used for transporting loads, such as logs, pipes, structural members or other long objects, that are generally capable of supporting themselves like beams between supports.

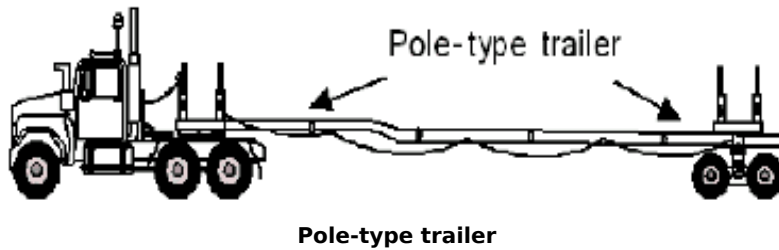

police vehicle means a vehicle driven by:

- (a) a member or special member of the Australian Federal Police, or
- (b) a member, however described, of the Police Force of a State or Territory, or
- (c) a service police officer within the meaning of the *Defence Force Discipline Act 1982* of the Commonwealth,

acting in the course of his or her duty.

primary production means:

- (a) the cultivation of land for the purpose of selling the produce of the land,
- (b) the maintenance of animals (including birds), whether wild or domesticated, for the purpose of selling them or their natural increase or bodily produce,
- (c) commercial fishing or the commercial farming of fish, molluscs, crustaceans or other aquatic animals,
- (d) the keeping of bees for the purpose of selling their honey or other apiary products,
- (e) timber-getting for commercial purposes,
- (f) mining for commercial purposes.

prime mover means a motor vehicle built to tow a semi-trailer.

proprietor's authority means an authority in force under clause 59.

public passenger vehicle means a registrable vehicle that is constructed principally for the conveyance of passengers and that is:

- (a) used for conveying passengers for hire or reward, or
- (b) equipped to seat more than 8 adults, including the driver, and is used for conveying passengers in the course of trade or business.

public utility service vehicle means a vehicle being used by a public authority or statutory body, or an authorised distributor under the *Electricity Network Assets (Authorised Transactions) Act 2015*, in connection with the supply of water, gas, electricity or the like or to remove garbage.

quad-axle group means a group of 4 axles, in which the horizontal distance between the centre lines of the outermost axles is more than 3.2 metres but not more than 4.9 metres.

rear fog light means a light used on a vehicle to make it more easily visible from the rear in dense fog.

rear overhang, of a vehicle, means the distance between the rear overhang line and the rear of the vehicle.

rear overhang line means:

- (a) if there is a single axle at the rear of the vehicle—the centre line of the axle, or
- (b) if there is an axle group at the rear of the vehicle—the centre of the axle group, decided without regard to the presence of any steerable axle unless all axles in the group are steerable.

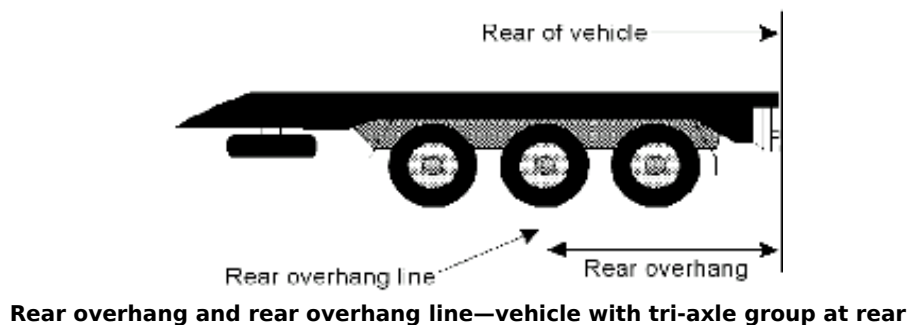
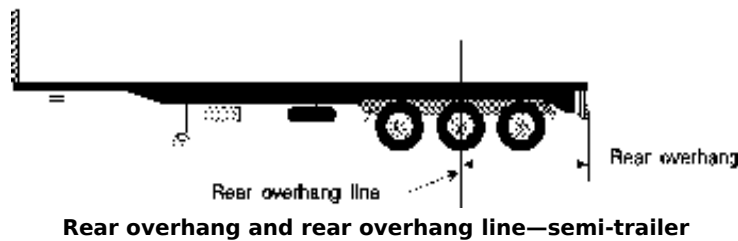
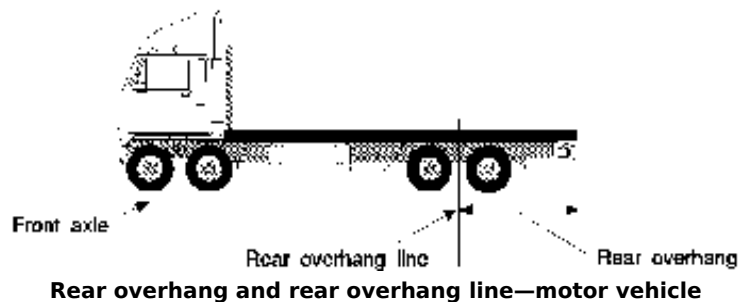

Register means the NSW registrable vehicles register.

registration label means a registration label issued under clause 16.

registration number means a number referred to in clause 19 (1).

relevant registration charge for a vehicle means:

- (a) in relation to a heavy vehicle—the amount payable as a registration charge under Schedule 2 to the Act, or
- (b) in relation to a light vehicle—the amount payable as motor vehicle tax under the [Motor Vehicles](#)

Taxation Act 1988.

repeater horn means a device which makes a sound alternating between different tones or frequencies on a regular time cycle.

restored vehicle means a vehicle that is being or has been restored to its manufacturer's specifications, so far as it is reasonably practicable to meet those specifications.

retractable axle means an axle with a means of adjustment enabling it to be raised or lowered relative to the other axles in the axle group.

right, in relation to a vehicle, means to the right of the centre of the vehicle when viewed by a person in the vehicle and facing towards the front of the vehicle.

road tank vehicle has the same meaning as in the sixth edition of the *Australian Code for the Transport of Dangerous Goods by Road and Rail*.

road train means a combination, other than a B-double, consisting of a motor vehicle towing at least 2 trailers (counting as one trailer and a converter dolly supporting a semi-trailer).



Road train

safety risk means danger to a person, to property or to the environment.

seasonal vehicle means a registrable vehicle used during part of the year only and of a type approved by the Authority for seasonal use.

seatbelt means a belt or similar device that is fitted to a motor vehicle and designed to restrain or limit the movement of a person who is seated in the vehicle and wearing the belt or device if the vehicle suddenly accelerates or decelerates.

seatbelt anchorage means the part of a motor vehicle which is designed to secure a seatbelt to the motor vehicle.

second edition ADR means an ADR contained in the publication known as the *Australian Design Rules for Motor Vehicle Safety, Second Edition* originally published by the then Commonwealth Department of Transport.

security interest means an interest in, or a power over, goods that secures payment of a debt or other pecuniary obligation or the performance of any other obligation and includes any interest in, or power over, goods of a lessor, owner or other supplier of goods, but does not include a possessory lien or pledge.

semi-trailer means a trailer (including a pole-type trailer) that has:

- (a) one axle group or single axle towards the rear, and
- (b) a means of attachment to a prime mover that would result in some of the load being imposed on

the prime mover.

service brake means the brake normally used to decelerate a vehicle.

sidecar means any car, box or other receptacle attached to the side of a motor bike and for the carriage of which a third wheel is provided.

side marker light means a light which, when lighted, is visible from the side of the vehicle on which it is affixed.

single axle means an axle not forming part of an axle group.

single axle group means a group of 2 or more axles in which the horizontal distance between the centre lines of the outermost axles is less than 1 metre.

special number-plate means a number-plate that has a special design, content or format designated by the Authority from time to time as constituting a special number-plate for the purposes of this Regulation.

spring brake means a brake using one or more springs to store the energy required to operate the brake.

standard number-plate means a number-plate that is not a special number-plate.

station wagon means a motor vehicle:

- (a) in which such part of the body form as is adjacent to and forward of the front seat or seats, and the greater part of the mechanical equipment, are the same or substantially the same as in a car of the same make, and
- (b) in which the body is carried without significant reduction in height from the front seat or seats to, or substantially towards, the rear of the vehicle, and
- (c) that has an entrance at the rear suitable for the loading and unloading of goods, and
- (d) that is manufactured with a rear seat or seats which can be folded or removed readily to provide additional floor space for the carriage of goods, and
- (e) that, when the seat or seats immediately to the rear of the front seat or seats are in position for the accommodation of persons, has a substantial space for the carriage of goods in proportion to the overall size of the interior of the vehicle.

steerable axle means an axle the wheels of which are connected to a steering mechanism for the vehicle.

street rod vehicle means a vehicle that has been modified for safe road use and that:

- (a) has a body and frame that were built before 1949, or
- (b) is a replica of a vehicle the body and frame of which were built before 1949.

street vending vehicle means a motor vehicle or trailer used for the hawking of ice cream (including any form of frozen confection containing ice cream, flavoured ice, fruit-ice, water-ice or a substitute for

ice cream) or chocolates, sweets or other confectionery.

tandem axle group means a group of at least 2 axles in which the horizontal distance between the centre lines of the outermost axles is at least 1 metre, but not more than 2 metres.

taxi-cab means a motor vehicle (other than a bus) that plies or stands in a road or road related area for hire for the conveyance of passengers.

the Act means the [Road Transport Act 2013](#).

third edition ADR means an ADR contained in the publication known as the *Australian Design Rules for Motor Vehicle and Trailers, Third Edition* published by the Federal Office of Road Safety of the Commonwealth Department of Transport and Regional Services.

third party insurance legislation means the provisions of the [Motor Accidents Compensation Act 1999](#) relating to:

- (a) compensation in respect of third parties who are injured or killed by the use of motor vehicles or trailers, or
- (b) payment of contributions towards compensation of that kind.

tow coupling means a mechanical assembly by means of which a flexible connection is effected between 2 component vehicles of a motor vehicle combination.

tow coupling overhang means the horizontal distance from the centre of the axle group, or the centre line of the single axle, at the rear of a vehicle to the pivot point of the coupling near the rear of the vehicle.

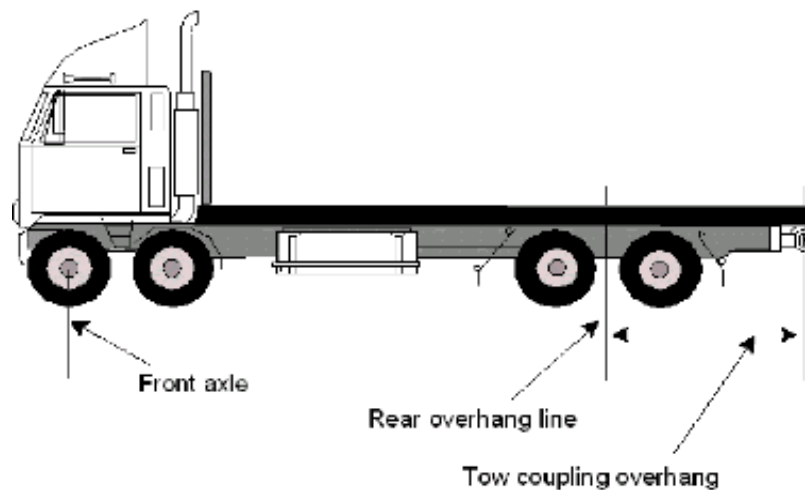

Tow coupling overhang—motor vehicle

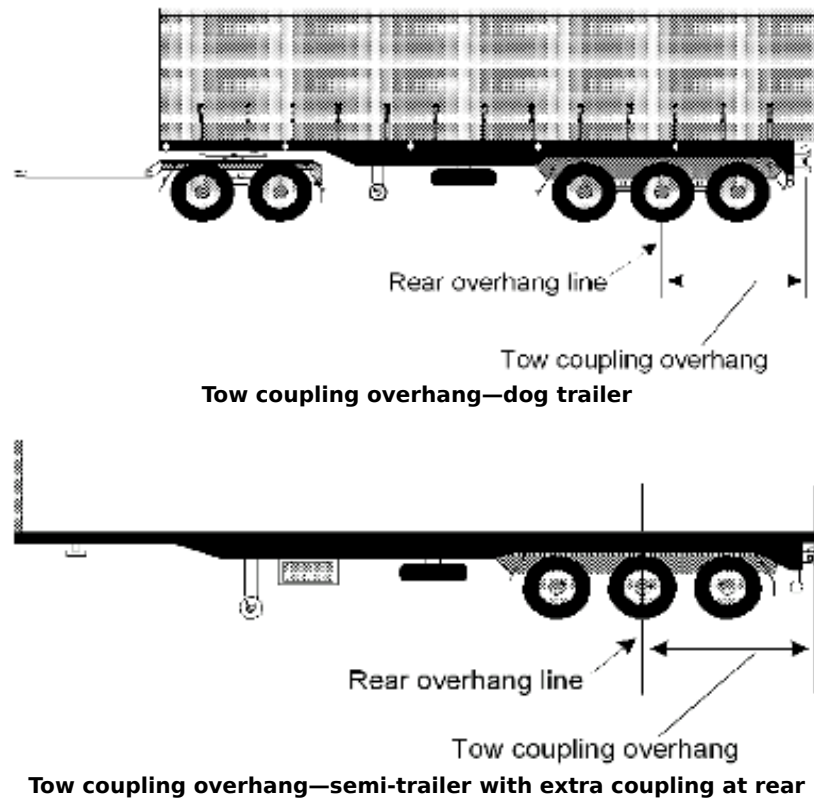

tow truck means a motor lorry, operated or proposed to be operated by a tow truck operator, that is used for towing broken down or damaged vehicles and which comprises or has permanently affixed to it a crane or similar apparatus for lifting a vehicle partially clear of the ground and is equipped to maintain it in such a position while towing it and includes a tow truck within the meaning of the [Tow Truck Industry Act 1998](#).

tow truck operator has the same meaning as it has in the [Tow Truck Industry Act 1998](#).

tractor means any motor vehicle constructed principally for the purpose of supplying motive power for machinery or of hauling any vehicle, but which is not capable of carrying any loading (other than tools, spare parts, fuel, water, oil, or other accessories necessary for use in connection with the vehicle) or any part of the weight of a vehicle being drawn or its loading.

trader means a person who is entitled to hold a trader's plate.

tri-axle group means a group of at least 3 axles, in which the horizontal distance between the centre lines of the outermost axles is more than 2 metres, but not more than 3.2 metres.

turntable means a bearing that is built to carry vertical and horizontal loads, but does not allow quick separation of its upper and lower rotating elements, and that is used to connect and allow articulation between:

- (a) a prime mover and a semi-trailer, or
- (b) the steering axle or axle group of a dog trailer and the body of the trailer, or
- (c) a fifth wheel coupling and the vehicle to which it is mounted.

twinsteer axle group means a group of 2 axles:

- (a) with single tyres, and
- (b) fitted to a motor vehicle, and
- (c) connected to the same steering mechanism, and
- (d) the horizontal distance between the centre lines of which is at least 1 metre, but not more than 2 metres.

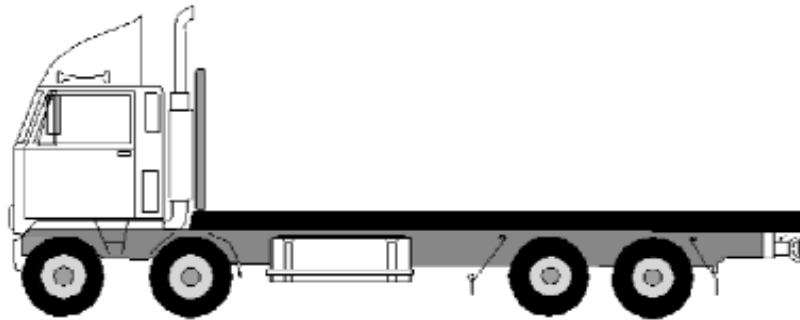

Twinsteer axle group on a motor vehicle

vacuum brakes means vacuum-operated or vacuum-assisted brakes.

vehicle defect notice means a defect notice referred to in section 76 (4) (a) of the Act.

vehicle inspection station means a place operated by the Authority for the purpose of determining whether registrable vehicles comply with the applicable vehicle standards for the vehicles.

vehicle number-plate—see clause 17.

vehicle registration authority, in relation to a vehicle, means:

- (a) the authority that last registered the vehicle, or
- (b) if the vehicle has never been registered—the authority responsible for registering vehicles in the jurisdiction in which the vehicle is used or is intended to be used.

Vehicle Standards Bulletin 14 means the *National Code of Practice for Light Vehicle Construction and Modification* published in 2011 by the Commonwealth Department of Infrastructure and Transport (or any Department that succeeds that Department), as amended from time to time.

VIN means the Vehicle Identification Number allocated in accordance with the ADRs.

windscreen means the main front windscreen and does not include any wind deflector or other subsidiary windscreen.

yellow includes amber.

20 metre double combination means a road train consisting of an articulated vehicle hauling one trailer, the overall length of which does not exceed 20 metres.

50 millimetre kingpin means a kingpin meeting the dimension requirements for a 50 millimetre

kingpin in Australian Standard AS 2175-1990 *Articulated Vehicles—Kingpins*.

75 millimetre kingpin means a kingpin with the dimensions specified in clause 173 (3) and (4) (including the diagram in subclause (3)) of Schedule 2.

90 millimetre kingpin means a kingpin meeting the dimension requirements for a 90 millimetre kingpin in Australian Standard AS 2175-1990 *Articulated Vehicles—Kingpins*.