

Surveying Regulation 2006

[2006-530]



New South Wales

Status Information

Currency of version

Historical version for 1 July 2009 to 13 December 2009 (accessed 30 June 2024 at 10:26)

Legislation on this site is usually updated within 3 working days after a change to the legislation.

Provisions in force

The provisions displayed in this version of the legislation have all commenced.

Notes—

- **See also**
[Surveying Amendment Bill 2009](#)

Authorisation

This version of the legislation is compiled and maintained in a database of legislation by the Parliamentary Counsel's Office and published on the NSW legislation website, and is certified as the form of that legislation that is correct under section 45C of the [Interpretation Act 1987](#).

File last modified 21 October 2009

Surveying Regulation 2006



New South Wales

Contents

Part 1 Preliminary	7
1 Name of Regulation	7
2 Commencement	7
3 Application of Regulation	7
4 Mining surveys.....	7
5 Definitions	8
Part 2 Survey practice	10
Division 1 General duties of surveyor	10
6 General principles of survey	10
7 Surveyor to obtain information.....	10
8 Surveyor to meet requisitions.....	11
9 Surveys not requiring strict accuracy	11
10 Surveys for identification or re-marking	11
11 Effect of contravention of Part.....	11
Division 2 Adoption of datum lines and bench marks	12
12 Datum line.....	12
13 Bench marks.....	13
Division 3 Measurement and calculations	13
14 Equipment for measurement of surveys.....	13
15 Measurement of boundaries and lines.....	14
16 Measurement by remote-sensing methods	14

17 Confirming terminals where part only of land to be surveyed.....	14
18 Surveys for affecting interests.....	14
19 Re-survey of property boundaries	15
20 Survey where boundary includes crooked fence	16
21 Calculation of areas of land	16
22 Surveys using GNSS equipment	16
23 Surveyor to check angular work.....	16
24 Accuracy of angular measurements	16
25 Accuracy of length measurements	17
26 Checking accuracy of measurements.....	17
Division 4 Use of survey marks and monuments.....	17
Subdivision 1 Surveys generally	17
27 Forms and styles of survey marks	17
28 Marking of urban surveys	18
29 Marking of rural surveys	18
30 Corners to be marked with boundary marks	19
31 Roads to be marked with reference marks	19
32 Procedure on finding existing corner peg and reference mark	20
33 Procedure if monuments of original survey missing	20
34 Procedure if differences exist between measured and recorded lengths.....	21
35 Surveyor to note nature and position of survey marks etc.....	21
36 Marking of survey boundaries	22
37 Placement of reference marks.....	22
38 Use of broad arrows.....	22
39 Deferment of placement of survey marks	22
40 Surveyor to report position of permanent survey marks	23
Subdivision 2 Surveys to be lodged with public authorities	23
41 Application.....	23
42 Surveys redefining or creating multiple parcels, roads or affecting interests.....	23
43 Connection to permanent survey marks.....	24
44 New permanent survey marks.....	24

Division 5 Boundaries formed by tidal and non-tidal waters and other natural features

.....	25
45 Definitions	25
46 Surveys where boundary includes tidal or non-tidal waters or other natural feature	25
47 First survey of boundary of land adjoining Crown reserve or Crown Road	25
48 Changes in boundaries formed by tidal waters	26
49 Changes in boundaries formed by lakes, streams and natural features	27
50 Surveyor to report on certain determinations	28
51 References to high-water mark and tidal waters in previous survey plans	28

Division 6 Field notes

Note.....	28
52 Surveyor to make field notes.....	29
53 Surveyor to retain electronic records	29
54 Surveyor to record datum line in field notes	29
55 Surveyor to record astronomical observations	29
56 Surveyor to record landmarks	30
57 Surveyor to sign and date field notes.....	30
58 Method of recording angles and bearings	30

Division 7 Survey plans

Note.....	30
59 Medium and format of survey plans	30
60 Survey plan to indicate name of locality and type of survey	30
61 Method of recording datum line	30
62 Method of recording bench marks	31
63 Connection of reference marks to points on survey plan	31
64 Method of showing boundaries generally	32
65 Method of showing natural feature boundaries	32
66 Surveys of land fronting tidal waters	32
67 GNSS-derived lines to be indicated	32
68 Conventional signs and symbols to be used on survey plans.....	33
69 Surveyor to report on doubts, discrepancies and difficulties	33

70 Surveyor to furnish survey certificate.....	33
Division 8 Public surveys	33
71 Standards for public surveys under sections 4 and 5 of the Act.....	33
72 Field notes for surveys under section 5 of the Act.....	33
Part 3 Administration	34
Division 1 Constitution of Board	34
73 Constitution of Board.....	34
74 Committees to assist Board.....	34
Division 2 Formal Board determinations	34
75 Formal Board determinations	34
Division 3 Registration of surveyors	35
76 Application of Division	35
77 Qualifications for registration	35
78 Board examinations.....	35
79 Provision of further information and supporting evidence.....	36
80 Continuing professional development	36
81 Conditions of registration as mining surveyor	36
82 Register of surveyors.....	36
83 Certificates of meritorious service.....	37
Division 4 Complaints concerning surveyors' conduct	37
84 Complaints against registered surveyors	37
Part 4 Miscellaneous	37
85 Fees and deposits.....	37
86 Notice of proposed entry to land under section 19 of the Act	37
87 Certificate of authority under section 26 of the Act.....	38
88 Applications to remove survey marks under section 24 of the Act.....	38
89 Exemption by Surveyor-General	38
90 Savings provision.....	38
Schedule 1 Forms	38

Schedule 2 Boundary marks	39
Schedule 3 Reference marks	42
Schedule 4 Permanent survey marks	43
Schedule 5 Conventional signs and symbols	51
Schedule 6 Fees and deposits	52

Surveying Regulation 2006



New South Wales

Part 1 Preliminary

1 Name of Regulation

This Regulation is the *Surveying Regulation 2006*.

2 Commencement

This Regulation commences on 1 September 2006.

Note—

This Regulation replaces the *Surveying Regulation 2001*, to be repealed on 1 September 2006 by section 10 (2) of the *Subordinate Legislation Act 1989*.

3 Application of Regulation

This Regulation applies to all land surveys, and to all surveys referred to in section 4 or 5 of the Act, but does not apply to any mining surveys except to the extent to which the other provisions of this Regulation expressly provide and to the extent provided by an order in force under clause 4.

4 Mining surveys

- (1) The Surveyor-General may, by order published in the Gazette, give directions with respect to the conduct of mining surveys.
- (2) Such an order may only be made on the recommendation of the Board.
- (3) The document entitled *Survey and Drafting Directions for Mine Surveyors*, published in March 2000 by the Department of Mineral Resources, is taken to be an order under this clause with respect to mining surveys carried out for the purposes of the *Coal Mines Regulation Act 1982* and the *Coal Mine Health and Safety Act 2002*, and may be amended and repealed accordingly.
- (4) The document entitled *Survey and Drafting Directions for Mining Surveyors*, published in December 2001 by the Department of Mineral Resources, is taken to be an order under this clause with respect to mining surveys carried out for the purposes of the *Mines Inspection Act 1901* and the *Mine Health and Safety Act 2004*, and may be

amended and repealed accordingly.

5 Definitions

(1) In this Regulation:

accurate AHD value, in relation to the height above or below AHD of a survey mark, means a value equal to or better than Class “B” or Class “LD”.

affecting interest means an easement, restriction on the use of land, positive covenant or profit à prendre.

AHD means Australian Height Datum, as defined in section 3 (1) of the Act.

appropriate accuracy, in relation to a particular survey, means such accuracy as is reasonably attainable in relation to that survey.

approved means approved by the Surveyor-General.

Board examination means an examination (whether oral or written, or both oral and written) approved by the Board for the purposes of this definition, as set out in a formal Board determination.

boundary mark means a mark of the kind referred to in Schedule 2.

Class, followed by one or more letters or numbers, means a Class of the standard described by those letters or numbers in the *Standards and Practices for Control Surveys*.

continuing professional development requirements means professional development requirements approved by the Board for the purposes of this definition, as set out in a formal Board determination.

established survey mark means a survey mark that is described in the register of public surveys as having a horizontal position equal to or better than Class “C”.

formal Board determination means a determination that has been made and published by the Board under clause 75.

GNSS means a global navigation satellite system.

lockspit means a mark described as a lockspit in Schedule 2.

mean high-water mark means the line of mean high tide between the ordinary high-water spring and ordinary high-water neap tides.

MGA means Map Grid of Australia, that is, a rectangular co-ordinate system using a Universal Transverse Mercator projection with zones 6 degrees wide and based on the Geocentric Datum of Australia.

monument means a natural or artificial object, or a point on a natural or artificial object, that is shown on an existing survey plan held by a public authority for the purpose of locating or relocating a boundary or a point in a survey.

recognised practical experience, in relation to an applicant for registration as a surveyor, means experience in which:

(a) the applicant has been employed as a surveyor's assistant, whether in New South Wales or elsewhere, for one or more periods totalling:

(i) the equivalent of at least 2 years full-time employment (in the case of an application for registration as a land surveyor), or

(ii) the equivalent of at least 3 years full-time employment (in the case of registration as a mining surveyor),

during the 5-year period immediately preceding the application, and

(b) while so employed, the applicant has obtained practical experience in the conduct of land surveys or mining surveys, as the case requires, for a continuous period of at least one year.

recognised professional training agreement means a training agreement approved by the Board for the purposes of this definition, as set out in a formal Board determination.

recognised qualification means any qualification that the Board recognises to be an appropriate qualification for the purposes of this definition, as set out in a formal Board determination.

reference mark means a survey mark of the kind referred to in Schedule 3 or 4.

reference station means a GNSS base station that is described in the register of public surveys as having a horizontal position of Class "C" or better and a vertical position of Class "B" or better.

road includes any road, street, laneway, pathway or other means of access, either existing or proposed.

rural survey means a land survey that is not an urban survey.

Standards and Practices for Control Surveys means the publication entitled *Standards and Practices for Control Surveys (SP1)*, published by the Inter-Governmental Committee on Surveying and Mapping, as that publication is in force from time to time.

student of surveying means a person who is enrolled in a course of studies that leads to a recognised qualification.

survey certificate means a survey certificate referred to in clause 70.

survey drafter means a person who has such abilities and experience as the Board considers appropriate to qualify the person to be a survey drafter, as set out in a formal Board determination.

surveyor's assistant means a person who has such abilities and experience as the Board considers appropriate to qualify the person to be a surveyor's assistant, as set out in a formal Board determination.

the Act means the [Surveying Act 2002](#).

urban survey means a land survey of:

- (a) land that is within a zone identified in an environmental planning instrument, within the meaning of the [Environmental Planning and Assessment Act 1979](#), as being residential, rural residential, commercial or industrial, or
- (b) land on which development for residential, rural residential, commercial or industrial purposes is permitted to be carried out, whether or not pursuant to development consent under that Act.

- (2) In this Regulation, a reference to a Form is a reference to a Form set out in Schedule 1.
- (3) Notes in the text of this Regulation do not form part of this Regulation.

Part 2 Survey practice

Division 1 General duties of surveyor

6 General principles of survey

When carrying out a survey, a surveyor must, in accordance with this Part:

- (a) adopt a datum line and, if appropriate, bench marks for the survey, and
- (b) ascertain the positions of monuments relevant to the survey, and
- (c) locate or relocate the boundaries of the land surveyed, and
- (d) place appropriate survey marks for the survey, and
- (e) make complete field notes of the survey, and
- (f) if the purpose of the survey so requires, prepare a survey plan.

7 Surveyor to obtain information

A surveyor must obtain such information on public record as is necessary:

- (a) to locate or relocate the boundaries of any land to be surveyed, and
- (b) to connect the survey to the State control survey in accordance with this Part.

8 Surveyor to meet requisitions

A surveyor must promptly answer, and comply with, any requisitions from the Surveyor-General or Registrar-General.

9 Surveys not requiring strict accuracy

- (1) A surveyor may make a survey for a purpose not requiring strict accuracy under arrangements with a client, and in such a manner and with such marking as are agreed on between the surveyor and the client.
- (2) Subject to subclause (3), this Part does not apply to a survey referred to in subclause (1).
- (3) If the survey is to be lodged with a public authority and:
 - (a) the survey is of a class specified in the Surveyor-General's published directions to surveyors, the survey must comply with those directions, or
 - (b) the survey is not of a class so specified, the surveyor must obtain the Surveyor-General's approval for the survey and the survey must comply with the conditions of the approval.

10 Surveys for identification or re-marking

- (1) A surveyor may make a survey for the purpose of identifying the boundaries of a parcel of land, or of locating the parcel in relation to adjoining lands, in such manner as may be required by the nature of the survey.
- (2) A surveyor may make a survey requiring the re-marking of a parcel of land in such manner, and with such marks in such positions, as may be specially required by the relevant client.

Note—

A survey made under this subclause may not be used for the purpose of any disposition of land or any interest in land.

- (3) This clause and clauses 6 (a), (b), (c) and (e), 7, 14, 19, 22, 26, 33 and 52-58, but no other provisions of this Part, apply to a survey referred to in subclause (1) or (2).

11 Effect of contravention of Part

A surveyor who fails to comply with any requirement of this Part is not guilty of an offence, but under section 13 of the Act, may be guilty of professional misconduct.

Division 2 Adoption of datum lines and bench marks

12 Datum line

- (1) The position of the survey marks defining the datum line for a survey must be determined specifically for that survey.
- (2) The bearing used for the orientation of a survey must be adopted:
 - (a) in the case of an urban survey of land within 300 metres of 2 established survey marks, and
 - (b) in the case of a rural survey of land within 1,000 metres of 2 established survey marks,from the grid bearing derived from the MGA co-ordinates of those marks.
- (3) The bearing adopted under subclause (2) must be verified by angular connection, and (if practicable) distance connection, to at least one other established survey mark.
- (4) The MGA co-ordinates used to determine the orientation of the survey must have been obtained from the register of public surveys within 6 months before the date of completion of the survey, as recorded in the survey certificate.
- (5) If a comparison of those connections reveals differences exceeding 20mm + 100 parts per million, the surveyor:
 - (a) must show on the survey plan all the observed and calculated bearings and distances, and
 - (b) must either:
 - (i) include on the survey plan an additional connection to at least one other established survey mark, or
 - (ii) forward a report of the survey to the Surveyor-General.
- (6) In the case of any survey of land not referred to in subclause (2), the bearing used for the orientation of the survey must be adopted:
 - (a) from a survey for which a plan or description is filed or recorded at a public authority, or
 - (b) from astronomical or GNSS observations,in which case the survey plan must state from what the orientation has been derived.
- (7) The GNSS observations referred to in subclause (6) (b) must be derived from at least 2 independent connections to established survey marks or reference stations.

13 Bench marks

- (1) All levels must be related to AHD or such other datum as is approved.
- (2) AHD must be verified by closed height difference between 2 bench marks that each have accurate AHD values.
- (3) All height differences verified or derived for a survey must attain an accuracy equal to or better than Class "B" or "LD".
- (4) In a survey for the purpose of a limitation in height or depth (or both), the surveyor must relate the survey to 2 or more bench marks of which one or more must be external to the land surveyed.
- (5) The external bench mark, or at least one of the external bench marks, must be:
 - (a) an existing permanent survey mark within 300 metres of the parcel, or
 - (b) if it is impracticable to use an existing permanent survey mark, a new permanent survey mark placed, in accordance with clause 44, within 300 metres of the parcel.

Division 3 Measurement and calculations

14 Equipment for measurement of surveys

- (1) A survey must be made using appropriate equipment.
- (2) A surveyor must not use any equipment in making a survey unless the surveyor knows the accuracy obtained by its use. That accuracy must be determined by reference to:
 - (a) the Australian primary standard of measurement of length, within the meaning of the *National Measurement Act 1960* of the Commonwealth, or
 - (b) the State primary standard of measurement of length, within the meaning of that Act, that is under the control of the Surveyor-General, or
 - (c) in the case of GNSS equipment, at least 3 established survey marks with accurate AHD values.
- (3) A surveyor must not use any steel or invar band in making a survey unless it is verified at least once every 2 years and immediately after any repair.
- (4) A surveyor must not use any electronic distance measuring equipment in making a survey unless it is verified against the State primary standard of measurement of length (as referred to above), by using pillared testlines, at least once every year and immediately after any service or repair.

- (5) A surveyor must not use any GNSS equipment in making a survey unless it is verified against the State control survey:
 - (a) at least once every year, and
 - (b) immediately after any service or repair, and
 - (c) immediately after any change or upgrade of software.
- (6) The accuracy and method of any verification under this clause must be as approved.

15 Measurement of boundaries and lines

A surveyor must measure boundaries by the most direct method reasonably practicable.

16 Measurement by remote-sensing methods

- (1) A surveyor may use measurements derived from approved photogrammetry or approved remote-sensing methods.
- (2) If any methods referred to in subclause (1) are used, the surveyor must indicate the methods on the survey plan.

17 Confirming terminals where part only of land to be surveyed

If a survey affects only part of the land in a document of title, the surveyor must connect the terminals of the survey to monuments having a known relation to the corners of the land in the document so as to confirm the position of each terminal.

18 Surveys for affecting interests

- (1) If a survey is carried out for the purpose of defining an affecting interest, the surveyor must connect the site of the affecting interest by measurement to relevant monuments.
- (2) If the affecting interest:
 - (a) intersects a boundary of land held in different ownership, or
 - (b) terminates at a boundary, whether of land held in the same or different ownership,the surveyor must redefine the boundary and show connections on the survey plan from the affecting interest to the nearest corner of the boundary.
- (3) The surveyor must ensure that the survey has the following reference marks:
 - (a) for affecting interests less than or equal to 200 metres in length, a reference mark at one terminal of the affecting interest,
 - (b) for affecting interests more than 200 metres in length, a reference mark at each

terminal of the affecting interest,

(c) for affecting interests regardless of length, additional reference marks:

(i) for an urban survey, at intervals not exceeding 500 metres, or

(ii) for a rural survey, at intervals not exceeding 1,000 metres.

(4) Subclause (3) does not apply to:

(a) an easement to be created over existing pipes and conduits that are underground,
or

(b) an easement to be created over existing pipes and conduits that are within a
building and whose precise location cannot reasonably be determined,

in which case the approximate positions must be shown on the survey plan, together
with appropriate notations.

(5) Subclause (3) does not apply to an easement to be created over an existing access
track that is identified on a plan, map, aerial photograph or satellite image, or by field
measurements, but the approximate positions of any intersections between the
easement and existing parcel boundaries must be shown on the survey plan, together
with appropriate notations.

(6) The essential dimensions of the site of the affecting interest must be shown on the
survey plan by bearing and distance.

(7) In any case, the surveyor must note the site on the plan as:

(a) "easement", "restriction on the use of land", "positive covenant" or "profit à
prendre", or

(b) "proposed easement", "proposed restriction on the use of land", "proposed
positive covenant" or "proposed profit à prendre".

19 Re-survey of property boundaries

(1) If a surveyor makes a re-survey, the surveyor must adopt the boundaries as originally
marked on the ground as the true boundaries unless there is sufficient evidence to
show that the marks have been incorrectly placed or have been disturbed.

(2) The surveyor:

(a) must disclose on the survey plan the extent of any discrepancy in the marking of
boundaries, and

(b) if the marks are shown on an original Crown survey plan, must advise the
Surveyor-General of the discrepancy in writing within 2 months after completing

the survey.

20 Survey where boundary includes crooked fence

If a crooked fence is used to define a boundary, the surveyor:

- (a) must survey the crooked fence and place the angle points of the boundary in such a way that the boundary line does not leave the material of the fence at the surface of the ground, and
- (b) must indicate on the survey plan both the location and nature of the angle points, and
- (c) must indicate on the survey plan the age, nature and construction material of the fence, as at the date of the survey.

21 Calculation of areas of land

Areas of land must be computed by an approved method that provides appropriate accuracy for the type of survey being conducted.

22 Surveys using GNSS equipment

When making a survey using GNSS equipment, a surveyor must use an approved technique that provides appropriate accuracy for the type of survey being undertaken.

23 Surveyor to check angular work

- (1) In the case of a survey in which the total length of surveyed boundaries exceeds 10,000 metres, a surveyor must check the angular work in the survey by astronomical observation, by comparison with a GNSS observation, by a complete angular close or by a comparison with the State control survey.
- (2) Any such comparison must be shown on the survey plan.
- (3) A surveyor must not interpolate any angular measurement by another surveyor.

24 Accuracy of angular measurements

- (1) Whenever practicable, a complete angular close must be obtained.
- (2) The angular misclose must not exceed 20 seconds plus $10\sqrt{n}$ seconds or 2 minutes (whichever is the lesser):
 - (a) for the whole surround, and
 - (b) between stations at which astronomical observations for azimuth have been made, and
 - (c) between stations at which GNSS observations for orientation have been made, and

(d) between pairs of established survey marks.

(3) In subclause (2), “n” represents the number of traverse angular stations.

25 Accuracy of length measurements

(1) A length measurement must be verified, either directly by means of a second measurement of that length or indirectly by calculation of that length from the measurements of other lengths and angles.

(2) In making a survey, a surveyor must measure all lengths to an accuracy of 10 mm + 15 parts per million or better at a confidence interval of 67%.

26 Checking accuracy of measurements

(1) If the nature of the survey permits, a surveyor must check all measurements by closure of the eastings and northings of the lines in all surrounds, computed (in metres) to 3 decimal places.

(2) The internal closure of any survey must be such that the length of the misclose vector must not exceed 15mm + 100 parts per million of the perimeter.

(3) The misclose vector must be determined as $\sqrt{a^2 + b^2}$, where “a” represents the misclose in eastings and “b” represents the misclose in northings.

(4) All computations and transformations to be used in the preparation of a survey plan must be checked for accuracy.

Division 4 Use of survey marks and monuments

Subdivision 1 Surveys generally

27 Forms and styles of survey marks

(1) The forms and styles of marks described in Schedule 4 are declared to be the forms and styles for **permanent survey marks** under the Act.

Note—

Schedule 4 lists permanent survey marks by Type number, using the same Type numbers as have been allocated by previous regulations. Type numbers 3 and 5 are now obsolete, and so do not appear in the Schedule.

(2) The forms and styles of marks described in Schedules 2, 3 and 4 (boundary marks, reference marks and permanent survey marks) are declared to be the forms and styles for **survey marks** under the Act.

(3) Survey marks must be placed and used in accordance with any requirements specified in Schedules 2, 3 and 4.

(4) When a reference mark is required to be placed for the purposes of a survey, the form

and style of reference mark to be used is to be chosen in the order of preference in which they are listed in Schedule 3.

28 Marking of urban surveys

- (1) An urban survey of land that abuts a road must have reference marks:
 - (a) at each extremity of the land surveyed, and
 - (b) at intervals of not more than 100 metres along so much of the road frontage as will have intervening side boundaries at intervals of 100 metres or less.
- (2) An urban survey of land that does not abut a road must have at least 2 reference marks at suitable locations in relation to the land surveyed.
- (3) Subclause (1) does not require the placement of a reference mark at any extremity of the land if some other reference mark is already placed within 10 metres of that extremity and that reference mark is referenced to that extremity on the survey plan.

29 Marking of rural surveys

- (1) In a rural survey, a surveyor must mark definitely and durably, by means of boundary marks, all lines that form or are to form the boundaries between parcels.
- (2) In addition, if a boundary is unfenced:
 - (a) the lines that form it must also be marked with lockspits cut in the direction of the boundary from each corner or angle or, if an obstacle exists at a corner or angle, with a suitable reference mark near that corner or angle, and
 - (b) the pegs and lockspits, or marks and lockspits, must be placed at intervals of not more than:
 - (i) 200 metres, where one peg or mark cannot be seen from the next, or
 - (ii) 500 metres, where one peg or mark can be seen from the next, and
 - (c) the survey plan must show the type and position of any line mark so placed, and
 - (d) unless environmental considerations dictate otherwise:
 - (i) the boundary must be reasonably cleared, and
 - (ii) any tree that has a trunk diameter greater than 100mm and is within 500mm of the boundary must be blazed or, if situated on the boundary, double blazed.
- (3) The surveyor must, in selected positions suitable for redefinition of the survey, connect, or place and connect, at least 2 reference marks for each parcel shown on the survey plan.

- (4) For a survey that affects only part of the land in a document of title, the surveyor must connect, or place and connect, at least one reference mark at each terminal of each section surveyed.
- (5) If a boundary (other than a road frontage) of the land exceeds 2,400 metres, a surveyor must place additional reference marks along the boundary at intervals of not more than 1,500 metres.
- (6) If a boundary required to be marked is a road frontage, a surveyor must place reference marks in accordance with clause 31 (5).
- (7) This clause does not apply to a survey referred to in clause 18.
- (8) In this clause, to **blaze** or **double blaze** a tree means to mark the tree with cuts in the approved manner.

30 Corners to be marked with boundary marks

- (1) Except in the case of a survey referred to in clause 9, 10 (1) or 18, each corner of the land surveyed (including the corners of each parcel of land in a subdivision) must be marked with a boundary mark.
- (2) If it is not practicable to place a boundary mark, a reference mark must be placed and the surveyor must note on the survey plan that the corner was not marked.
- (3) In a rural survey, if a fence post is on a corner at which a reference mark has been placed and reference is made to that post on the survey plan, no further marking of the corner is required.

31 Roads to be marked with reference marks

- (1) In the case of a survey made for the purpose of the creation, redefinition or widening of a road under any Act, a surveyor:
 - (a) must place reference marks in the positions prescribed by this clause, and
 - (b) must show the type and location of the reference marks in the survey plan.
- (2) If the survey is an urban survey, reference marks must be placed:
 - (a) at the junction or intersection of roads:
 - (i) if a triangle is cut off from the corner formed by the intersection of the road boundaries, so as to refer to each end of the base line of the triangle, or
 - (ii) if the corner is rounded off, so as to refer to each tangent point, or
 - (iii) if the corner is not cut off or rounded off, so as to refer to the point of intersection of the road boundaries, and

- (b) at the terminals of a road, and
 - (c) as far as is practicable, on the same side of the road, and
 - (d) if placed in a road that is variable in width, with connections made to both sides of the road, and
 - (e) at each angle of the road, and at each tangent point or terminal of a series of chords of a regular curve in the road.
- (3) Subclause (2) (e) does not require a reference mark to be placed within 30 metres of another reference mark.
- (4) If a reference mark consists of a drill hole and wing, there must be 2 such marks.
- (5) If the survey is a rural survey, reference marks must be placed in selected positions:
- (a) so as to refer to the terminals of the road surveyed and to each junction or intersection of any other roads, and
 - (b) in pairs suitable for orientation purposes throughout the whole length of the road, so that the maximum distance between any 2 successive reference marks does not exceed 1,000 metres.
- (6) If a road being created joins or intersects an existing road and reference marks have already been placed in the existing road:
- (a) the existing marks must be connected to the new reference marks placed in the road being created, and
 - (b) the orientation of the existing reference marks must be compared with the orientation of the new reference marks, and
 - (c) the comparison between each series of reference marks must be shown on the survey plan.

32 Procedure on finding existing corner peg and reference mark

If a corner peg and reference mark are found together, a surveyor must determine the bearing and distance between them and, if a difference from the original reference is disclosed, must decide from other evidence which of them to adopt and note details of the difference on the survey plan.

33 Procedure if monuments of original survey missing

To the extent that the relevant monuments of an original survey are missing, a surveyor must determine the boundaries and corners of the land surveyed by measurement in correct relation to:

- (a) adjoining or adjacent parcels of land, and
- (b) parcels of land on opposite sides of roads, and
- (c) fences, and
- (d) such other evidence of correct location as may be found after full investigation and inquiry.

34 Procedure if differences exist between measured and recorded lengths

- (1) If a measurement discloses the length of a boundary of land to be different from that indicated in the document of title to the land, the surveyor:
 - (a) must verify the length of the boundary, and
 - (b) must make appropriate entries in the surveyor's field notes, and
 - (c) must show, in the notes and on any survey plan, the monuments or other objects or points adopted for the purpose of verifying the length of the boundary.
- (2) In the absence of monuments defining the land, the surveyor must indicate on the survey plan whether there is sufficient land available to permit the adoption of the measurement referred to in subclause (1) without causing any encroachment on any road or any adjoining or adjacent parcel of land.

35 Surveyor to note nature and position of survey marks etc

- (1) A surveyor must indicate in the surveyor's field notes and on the survey plan:
 - (a) the nature and position of any survey mark or monument found by the surveyor, and
 - (b) the MGA co-ordinates of any permanent survey mark found or placed by the surveyor, together with an estimate of the accuracy of those co-ordinates, and
 - (c) the nature of any survey mark (other than a peg) placed by the surveyor, and
 - (d) the essential measurements from any reference mark, permanent survey mark or monument to the nearest corner, angle or line mark.
- (2) If reference marks are placed or found at depths of more than 150mm below the existing surface of the ground, the surveyor must indicate the depths on the survey plan.
- (3) If reference marks are found, the surveyor must note their origin on the survey plan by reference to the number of the plan on which the marks first occur.
- (4) A monument that is important for the definition of the land must be shown in the surveyor's field notes, and on the survey plan, with the annotation "found", "not

found”, “gone”, “disturbed” or “inaccessible”, as appropriate.

- (5) A monument must not be recorded as “gone” unless a thorough search for it has been made and the measurements of its probable site recorded in the surveyor’s field notes.

36 Marking of survey boundaries

- (1) Surveyed boundaries must be marked with boundary marks in such a manner that the boundaries are readily and unambiguously discernible on the ground.
- (2) If drill holes, chisel marks or similar marks are to be placed in an ornamental wall, ornamental path or similar structure, the size of the mark placed may be reduced to avoid undue damage to the wall, path or other structure being marked, but only if the marking is durable and readily and unambiguously discernible.

37 Placement of reference marks

A reference mark must be located in such a position as to preserve the mark from disturbance.

38 Use of broad arrows

A broad arrow may be used as a survey mark in relation only to a survey referred to in section 4 or 5 of the Act.

39 Deferment of placement of survey marks

- (1) If it is likely that any work to be carried out on land will disturb any survey mark to be placed on the land, a surveyor may defer the placement of the survey mark on that land.
- (2) In such a case, the surveyor:
 - (a) must notify the Surveyor-General of the deferment, and
 - (b) must deposit with the Surveyor-General the amount specified in Schedule 6 in that regard, and
 - (c) must comply with any requirement of the Surveyor-General.
- (3) On completion of the work, the surveyor:
 - (a) must place any deferred survey marks, and
 - (b) must have their nature and position noted on the survey plan in the manner approved by the Registrar-General, and
 - (c) must inform the Surveyor-General that the survey has been completed in accordance with any requirement referred to in subclause (2) (c).

- (4) If the Surveyor-General is satisfied that the survey has been satisfactorily completed, the deposit must be returned to the surveyor less an administrative charge not exceeding 15 per cent of the amount deposited.
- (5) A survey mark whose placement has been deferred under this clause must be placed within 28 days after completion of the relevant work.

40 Surveyor to report position of permanent survey marks

If, while carrying out a survey, a surveyor:

- (a) places a new permanent survey mark, or
- (b) becomes aware that an existing permanent survey mark has been removed, damaged, destroyed, displaced, obliterated or defaced, or is in a state of disrepair,

the surveyor must notify the Surveyor-General of that fact and of the number and location of the permanent survey mark concerned.

Subdivision 2 Surveys to be lodged with public authorities

41 Application

This Division applies to any survey that is carried out for the purpose of lodging a survey plan with a public authority.

42 Surveys redefining or creating multiple parcels, roads or affecting interests

- (1) A survey that redefines or creates parcels of land must be related to:
 - (a) for a survey for 1–10 parcels—no fewer than 2 permanent survey marks, or
 - (b) for a survey for 11–20 parcels—no fewer than 3 permanent survey marks, or
 - (c) for a survey for more than 20 parcels—no fewer than 4 permanent survey marks, plus an additional permanent survey mark for every 20 (or part of 20) by which the number of parcels exceeds 40.
- (2) A survey that redefines a road frontage or that is conducted for the purposes of creating a road under any Act must be related to 2 or more permanent survey marks for each interval of 1,000 metres (for an urban survey) or 2,000 metres (for a rural survey).
- (3) A survey for the purposes of creating an affecting interest must have 2 or more permanent survey marks for each interval of 2,000 metres (for an urban survey) or 4,000 metres (for a rural survey).
- (4) No more than 2 permanent survey marks existing at the time a survey referred to in subclause (1) is carried out may be used for the purposes of the survey concerned.

43 Connection to permanent survey marks

- (1) The permanent survey marks to which a survey is related must each be connected to separate corners of the land surveyed.
- (2) The distance between any such corner and the permanent survey mark to which it is connected must not exceed:
 - (a) 500 metres, in the case of an urban survey, or
 - (b) 1,000 metres, in the case of a rural survey.
- (3) Measurements between all permanent survey marks found or placed, and connections to the land surveyed, must be proved by closed survey and shown on the survey plan.

44 New permanent survey marks

- (1) A permanent survey mark placed for the purposes of a survey:
 - (a) must be so located as to be suitable for orientation of the survey and for redefinition of the survey, including orientation and redefinition by means of GNSS surveying techniques, and
 - (b) if situated at a road junction, road intersection, road angle or crest of a hill, must be so located as to be:
 - (i) visible from other permanent survey marks without obstruction, and
 - (ii) suitable for subsequent inclusion in the State control survey, and
 - (c) must be identified in a sketch plan prepared in accordance with approved standards.
- (2) If any two of the permanent survey marks referred to in clause 43 (1) have accurate AHD values, an accurate AHD value must be determined for any other permanent survey mark placed for the purposes of the survey.
- (3) A sketch plan referred to in subclause (1) (c):
 - (a) must show the nature of each permanent survey mark placed by the surveyor, and
 - (b) must show the MGA co-ordinates of each such mark, together with an estimate of the accuracy of those co-ordinates, and
 - (c) if an accurate AHD value has been determined for that mark in accordance with subclause (2), must show that value.
- (4) The sketch plan must be forwarded to the Surveyor-General within 2 months of the placement of the permanent survey mark concerned.

Division 5 Boundaries formed by tidal and non-tidal waters and other natural features

45 Definitions

In this Division:

bed, in relation to a lake or stream, includes any portion of the lake or stream:

- (a) that is alternately covered and left bare with an increase or diminution in the supply of water, and
- (b) that is adequate to contain the lake or stream at its average or mean stage without reference to extraordinary freshets in time of flood or to extreme droughts.

lake includes any permanent or temporary lagoon or a similar collection of water not contained in an artificial work, but does not include tidal waters.

natural feature includes any cliff face or ridgeline, but does not include any tidal or non-tidal waters.

stream includes any non-tidal waters that are not a lake.

46 Surveys where boundary includes tidal or non-tidal waters or other natural feature

- (1) A boundary formed by tidal waters, or by a lake, stream or natural feature, must be surveyed so that each change of course or direction of the boundary is determined with appropriate accuracy.
- (2) If the actual position of the mean high-water mark of tidal waters, the bank of the lake or stream or the natural feature is substantially different to the adopted position of the boundary, both the actual position and the adopted position are to be shown on the survey plan.
- (3) If:
 - (a) the middle line of a stream is the boundary of land and has not previously been defined by survey, or
 - (b) the middle line of a stream is otherwise required to be determined,both banks of the stream must be surveyed and shown on the survey plan together with the determination of the middle line.
- (4) The middle line of a stream need not be marked unless the purpose for which the survey is made so requires.

47 First survey of boundary of land adjoining Crown reserve or Crown Road

- (1) In any survey for the redefinition or subdivision of land adjoining an existing Crown

reserve of stipulated width fronting tidal waters, where the boundary between the land being surveyed and the Crown reserve has not previously been defined by survey, the boundary must be defined by straight lines approximately parallel to the position of the mean high-water mark as originally defined.

- (2) In any survey for the redefinition or subdivision of land adjoining an existing Crown reserve or Crown road of stipulated width fronting a lake, stream or natural feature, where the boundary between the land being surveyed and the Crown reserve or Crown road has not previously been defined by survey:
 - (a) the boundary must be defined by straight lines approximately parallel to the position of the bank of the lake or stream, or of the natural feature, as originally defined, and
 - (b) the position of the bank or natural feature, as originally defined, must be shown on the survey plan.
- (3) Approval to the definition of a boundary under subclause (1) or (2) must be obtained from the Minister administering the [Crown Lands Act 1989](#).
- (4) When seeking approval to a determination under subclause (3), a surveyor must provide the Minister administering the [Crown Lands Act 1989](#) with a comprehensive report regarding the surveyor's determination.
- (5) A comprehensive report under this clause must include:
 - (a) the basis and method of determining the position of the mean high-water mark, bank or natural feature fronted by the Crown reserve or Crown Road concerned, and
 - (b) the surveyor's opinion as to the reason for any change in that position and the process by which the change has taken place, and
 - (c) such photographs, documents or other information relevant to the position of the mean high-water mark as is reasonably required by the person to whom the report is to be provided.
- (6) In this clause:

Crown reserve has the same meaning as **reserve** has in Part 5 of the [Crown Lands Act 1989](#).

Crown road has the same meaning as it has in the [Roads Act 1993](#).

48 Changes in boundaries formed by tidal waters

- (1) If, since the date of a previous survey, there has been a change in the position of the mean high-water mark of tidal waters forming a boundary of land to be surveyed:

- (a) if the change arose from natural, gradual and imperceptible accretion or erosion—the position of the mean high-water mark as it is as the result of the change is to be adopted, or
 - (b) if the change arose otherwise than from natural, gradual and imperceptible accretion or erosion—the position of the mean high-water mark as it was before the change is to be adopted.
- (2) Approval to the adoption of a changed position referred to in subclause (1) (a) must be obtained from:
- (a) the Minister administering the *Crown Lands Act 1989*, if the adjoining land below the mean high-water mark is Crown land, or
 - (b) the owner of the adjoining land, if the adjoining land below the mean high-water mark is not Crown land.
- (3) When seeking approval to a determination under subclause (2), a surveyor must provide the Minister administering the *Crown Lands Act 1989* or the owner of the adjoining land, as the case requires, with a comprehensive report regarding the surveyor's determination.
- (4) A comprehensive report under this clause must include:
- (a) the basis and method of determining the position of the mean high-water mark, and
 - (b) the surveyor's opinion as to the reason for any change in that position and the process by which the change has taken place, and
 - (c) such photographs, documents or other information relevant to the position of the mean high-water mark as is reasonably required by the person to whom the report is to be provided.

Note—

In certain locations, the operation of this clause may be affected by Part 4B (Modification of doctrine of erosion and accretion) of the *Coastal Protection Act 1979*.

49 Changes in boundaries formed by lakes, streams and natural features

- (1) If, since the date of a previous survey, there has been a change in the position of the bank of a lake forming a boundary of land to be surveyed, then, in any subsequent survey, the position of the bank, as it was before the change, must be adopted.
- (2) If, since the date of a previous survey, there has been a change in the position of the bank of a stream, or of some other natural feature, forming a boundary of land to be surveyed, then, in any subsequent survey:

- (a) for any change arising from natural, gradual and imperceptible accretion or erosion, the position of the bank or natural feature, as it is as a result of the change, must be adopted, or
- (b) for any change arising otherwise than from natural, gradual and imperceptible accretion or erosion, the position of the bank or natural feature, as it was before the change, must be adopted.

50 Surveyor to report on certain determinations

- (1) A surveyor who determines a new position for the bank of a stream, or for a natural feature, in connection with a survey carried out for the purpose of lodging a survey plan with a public authority must lodge, together with the survey plan, a comprehensive report regarding the surveyor's determination of the new position.
- (2) A comprehensive report under this clause must include:
 - (a) the basis and method of determining the position of the bank or natural feature concerned, and
 - (b) the surveyor's opinion as to the reason for any change in that position and the process by which the change has taken place, and
 - (c) such photographs, documents or other information relevant to the position of the bank or natural feature as is reasonably required by the person to whom the report is to be provided.

51 References to high-water mark and tidal waters in previous survey plans

For the purposes of preparing a survey, in any previous survey plan or other description of land:

- (a) a reference to high-water mark is taken to be a reference to mean high-water mark, and
- (b) a reference to, or description of, a boundary that abuts tidal waters is taken to be a reference to, or description of, a boundary that abuts mean high-water mark, and
- (c) a reference to a bank of a lake or stream is taken to be a reference to the limit of the bed of the lake or stream, and
- (d) a reference to, or description of, a boundary that abuts a lake or stream is taken to be a reference to, or a description of, a boundary that abuts the limit of the bed of the lake or stream,

unless a contrary intention appears.

Division 6 Field notes

Note—

Other requirements with respect to the preparation of field notes are contained in various provisions in the earlier Divisions of this Part.

52 Surveyor to make field notes

- (1) A surveyor's field notes must be neat, precise, complete and readily intelligible in accordance with the usage of surveyors.
- (2) Facts, readings and observations must be recorded immediately after they are ascertained.
- (3) A surveyor must keep an archive of:
 - (a) all field notes made by the surveyor, with indices and cross-references set out in a manner that facilitates the preparation of a complete and accurate survey plan, and
 - (b) all other information and documentation relevant to those field notes.

53 Surveyor to retain electronic records

- (1) If a survey has been recorded in whole or in part by electronic methods other than GNSS methods:
 - (a) an electronic copy (in the same form as the recording), and
 - (b) a copy of the reduced and formatted data,must be retained in a manner that facilitates the preparation of a complete and accurate survey plan.
- (2) If a survey has been recorded in whole or in part by GNSS methods:
 - (a) an electronic copy of all recorded data, and
 - (b) a copy of the reduced baseline or positional results,must be retained in a form that facilitates the preparation of a complete and accurate survey plan.

54 Surveyor to record datum line in field notes

A surveyor must clearly indicate in the surveyor's field notes the datum line of the survey and the origin of the orientation adopted.

55 Surveyor to record astronomical observations

If a surveyor makes an astronomical observation in the course of a survey, the surveyor must enter the time and date and the latitude of the relevant station, together with full particulars of all observations.

56 Surveyor to record landmarks

A surveyor must enter the names of estates, houses, roads, rivers, creeks, lakes and the like, and house numbers, as far as they are material to the survey and ascertainable by the surveyor.

57 Surveyor to sign and date field notes

- (1) In the case of a survey that has been performed by a surveyor personally or under the surveyor's supervision, the surveyor must personally sign and date each page or sheet of the field notes and (in the case of a survey recorded by electronic means) each page or sheet of the reduced and formatted data.
- (2) Before signing each page or sheet, the surveyor must be satisfied that the notes on it are accurate and that the date when the work recorded on it was performed appears on it.

58 Method of recording angles and bearings

All angles and bearings must be observed and recorded in degrees, minutes and seconds, and all bearings must be reckoned and expressed clockwise from zero to 360 degrees.

Division 7 Survey plans

Note—

Other requirements with respect to the preparation of survey plans are contained in various provisions in the earlier Divisions of this Part.

59 Medium and format of survey plans

A survey plan must be prepared in an approved medium and format.

60 Survey plan to indicate name of locality and type of survey

A survey plan must indicate:

- (a) the name assigned by the Geographical Names Board to the locality within which the land concerned is situated, and
- (b) the name (if any) assigned by the local roads authority to any road shown on the plan, and
- (c) whether the survey is an urban or rural survey.

61 Method of recording datum line

- (1) The datum line adopted for a survey must be shown on the survey plan, by distinguishing characters placed at the terminals of the datum line, and the nature of the marks defining the datum line must be noted on the plan.

- (2) If the orientation of the survey is adopted from a grid bearing derived from MGA co-ordinates of established survey marks, the survey plan must show the following:
 - (a) the numbers assigned by the State control survey to the established survey marks,
 - (b) the MGA zone within which the land surveyed is situated,
 - (c) the easting and northing, referenced to the co-ordinates, of each established survey mark,
 - (d) the combined scale factor in relation to the co-ordinates,
 - (e) the date on which the co-ordinates were obtained from the register of public surveys,
 - (f) the accuracy of the co-ordinates, as described in the register of public surveys, for each survey mark.
- (3) If astronomical or GNSS observations are used to determine or confirm the orientation of the survey, the results of the observations are to be shown in a table on the survey plan under the headings "Occupied station", "Observed station" and "Astronomical body" or "GNSS", together with the derived bearing between the occupied and observed stations.

62 Method of recording bench marks

The following matters must be stated on the survey plan:

- (a) the nature, position and height value of each bench mark,
- (b) for each existing permanent survey mark that is used as a bench mark or to verify the height datum, the date on which the height value of that mark was obtained from the register of public surveys,
- (c) for each new permanent survey mark that is used as a bench mark, the accuracy of the height, as described in the register of public surveys, for that mark.

63 Connection of reference marks to points on survey plan

- (1) A reference mark may not be connected to more than one point on a survey plan.
- (2) A reference mark may not be connected to any point on a survey plan that is more than 30 metres from that mark.
- (3) Subclause (2) does not apply to a reference mark that is referenced to the extremity of the survey plan as referred to in clause 28 (3).

64 Method of showing boundaries generally

- (1) A survey plan must show:
 - (a) the nature of the boundaries at the time of the survey, whether defined by survey marks, lockspits, lines, fences, roads, natural or artificial features or buildings or walls, and
 - (b) the width of all walls used in common and the position of the boundaries in those walls, and
 - (c) the description (including the age, nature, construction material and relationship to the boundary) of any substantial structure (including any fence):
 - (i) that is within one metre of the boundary of the land surveyed, or
 - (ii) that is otherwise relevant to the boundary definition.
- (2) If a boundary is the face of a wall, the boundary must be described as “face of wall”.
- (3) A wall must not be described as a “party wall” unless:
 - (a) it is the subject of such easements as are referred to in relation to party walls in the [Conveyancing Act 1919](#), or
 - (b) the survey plan is intended to create such easements in respect of the wall.

65 Method of showing natural feature boundaries

A survey plan that shows a natural feature boundary:

- (a) must describe the natural feature, and
- (b) must indicate the boundary by a line that generally follows the line of the boundary, and
- (c) must approximate the boundary by bearings and distances.

66 Surveys of land fronting tidal waters

In the case of a survey of land adjoining tidal waters, a surveyor must show on a survey plan the description and relationship of any sea wall and reclaimed land adjacent to the mean high-water mark.

67 GNSS-derived lines to be indicated

A survey plan that includes lines derived from GNSS observations must indicate which of those lines have been so derived.

68 Conventional signs and symbols to be used on survey plans

In the preparation of any survey plan, the conventional signs and symbols set out in Schedule 5 must be used to indicate the matters to which they are referred by that Schedule.

69 Surveyor to report on doubts, discrepancies and difficulties

A surveyor must disclose any doubt, discrepancy or difficulty suggested by or encountered in a survey, either on the survey plan or in an accompanying comprehensive report.

70 Surveyor to furnish survey certificate

- (1) When furnishing a survey plan, a surveyor must endorse a survey certificate on, or provide a survey certificate with, the survey plan.
- (2) A survey certificate is to be in or to the effect of:
 - (a) Form 1, in relation to all surveys other than those referred to in clause 9, and
 - (b) Form 2, in relation to all surveys referred to in clause 9.
- (3) Subject to clause 39, a survey certificate must not be issued until all survey marks required to be placed in connection with the survey have been duly placed.
- (4) A survey certificate may be incorporated in any other certificate that must be endorsed or provided pursuant to any other Act or law.

Division 8 Public surveys

71 Standards for public surveys under sections 4 and 5 of the Act

- (1) A survey referred to in section 4 or 5 of the Act must be carried out in accordance with such of the standards set out in *Standards and Practices for Control Surveys* as the Surveyor-General may direct in relation to the survey, but subject to such variations in those standards as the Surveyor-General may direct.
- (2) In any survey referred to in section 5 of the Act, all measuring equipment used in the survey must comply with the requirements of Division 3.

72 Field notes for surveys under section 5 of the Act

The field notes prepared in relation to a survey referred to in section 5 of the Act, including any electronic field data:

- (a) must be referenced and indexed in an approved manner, and
- (b) must be produced to the Surveyor-General on request.

Part 3 Administration

Division 1 Constitution of Board

73 Constitution of Board

- (1) The Institution of Surveyors NSW Incorporated is prescribed as the professional association of land surveyors to nominate persons for appointment to the Board under section 27 (2) (c) of the Act.
- (2) AIMS—Australian Institute of Mine Surveyors Limited is prescribed as the professional association of mining surveyors to nominate persons for appointment to the Board under section 27 (2) (d) of the Act.

74 Committees to assist Board

- (1) This clause applies to any committee established under section 30 of the Act.
- (2) A committee must have at least 3 members.
- (3) The convenor and deputy convenor of a committee are to be nominated by the Board, and may (but need not) be members of the Board.
- (4) Committee meetings are to be held at the times and places determined by the convenor of the committee.
- (5) The procedures for convening committee meetings and for the conduct of business at committee meetings are to be determined by the convenor of the committee.
- (6) At a committee meeting, a majority of the committee members constitutes a quorum.
- (7) The convenor of a committee (or, in the absence of the convenor, the deputy convenor of the committee) is to preside at committee meetings.
- (8) A decision supported by a majority of the votes cast at a committee meeting at which a quorum is present constitutes a decision of the committee.
- (9) In the event of an equality of votes, the convenor of the committee has a second, or casting, vote.
- (10) The convenor of a committee is to report all decisions of the committee to the next Board meeting.

Division 2 Formal Board determinations

75 Formal Board determinations

- (1) The Board may, by resolution, make the following determinations for the purposes of the respective definitions in clause 5 (1):

- (a) a determination approving an examination for the purposes of the definition of **Board examination**,
 - (b) a determination approving requirements for the purposes of the definition of **continuing professional development requirements**,
 - (c) a determination approving a training agreement for the purposes of the definition of **recognised professional training agreement**,
 - (d) a determination recognising a qualification for the purposes of the definition of **recognised qualification**,
 - (e) a determination recognising abilities and experience (whether for a person or a class of persons) for the purposes of the definition of **survey drafter**,
 - (f) a determination recognising abilities and experience (whether for a person or a class of persons) for the purposes of the definition of **surveyor's assistant**.
- (2) The Board may, by resolution, make determinations as to what, in its opinion, constitutes general or immediate supervision for the purposes of section 21 (3) of the Act.
- (3) The Board is to ensure that copies of each of its determinations under this clause are published on its internet site and made available for inspection at each of its offices.

Division 3 Registration of surveyors

76 Application of Division

This Division applies to the registration of both land surveyors and mining surveyors.

77 Qualifications for registration

A person is eligible to be registered as a surveyor if the person:

- (a) holds a recognised qualification, and
- (b) has recognised practical experience, and
- (c) has either passed the Board's examination or fulfilled the requirements of a recognised professional training agreement, and
- (d) is of good character.

78 Board examinations

Board examinations are to be conducted at such times and places as the Board may determine.

79 Provision of further information and supporting evidence

Without limiting section 43 (1) of the *Licensing and Registration (Uniform Procedures) Act 2002*, the Board may require an applicant for registration as a surveyor to furnish the following documents:

- (a) documentary evidence that the applicant holds a recognised qualification,
- (b) documentary evidence that the applicant has recognised practical experience,
- (c) documentary evidence that the applicant has passed the relevant Board examination or fulfilled the requirements of a recognised professional training agreement,
- (d) one or more character references given in relation to the applicant within the previous 2 years,
- (e) a recent passport-sized photograph of the applicant's face.

80 Continuing professional development

- (1) A registered surveyor must comply with the continuing professional development requirements.
- (2) Compliance with the requirements of this clause is a condition of registration as a surveyor.

81 Conditions of registration as mining surveyor

Registration as a mining surveyor may be granted subject to a condition restricting the mining surveyor to the conduct of mining surveys in relation to open cut mines.

82 Register of surveyors

- (1) The following particulars are to be recorded in the register of surveyors, in relation to each registered surveyor, in addition to those required by section 49 (1) of the *Licensing and Registration (Uniform Procedures) Act 2002*:
 - (a) the qualifications pursuant to which the surveyor was registered,
 - (b) in the case of a surveyor who was originally registered or licensed interstate or overseas, the State, Territory or country in which the surveyor was originally registered or licensed,
 - (c) the surveyor's address for service of notices,
 - (d) particulars of any action that the Board has taken in relation to the surveyor under section 12 or 13 of the Act, together with the date on which the action was taken,
 - (e) in the case of a registered mining surveyor whose registration is subject to a condition restricting the mining surveyor to the conduct of mining surveys in

relation to open cut mines, a statement to that effect.

- (2) The register of surveyors may be maintained in written or electronic form.

83 Certificates of meritorious service

The Board may issue a certificate of meritorious service to any person who surrenders his or her certificate of registration, as referred to in section 50 (7) of the *Licensing and Registration (Uniform Procedures) Act 2002*, if satisfied that it is appropriate to do so in recognition of the person's contribution to surveying in New South Wales.

Division 4 Complaints concerning surveyors' conduct

84 Complaints against registered surveyors

- (1) Any person may lodge a complaint with the Board in relation to the conduct of a surveyor.
- (2) Any such complaint is to be dealt with in accordance with the document entitled *Policy for the Consideration of Complaints Against Surveyors* issued by the Board as in force from time to time.

Part 4 Miscellaneous

85 Fees and deposits

The fees and deposits set out in Schedule 6 are payable in relation to the various matters referred to in that Schedule.

86 Notice of proposed entry to land under section 19 of the Act

- (1) The notice referred to in section 19 (1) of the Act, whether for the conduct of a land survey or a mining survey, must be given in writing in the form set out in Form 3.
- (2) The notice may be given:
 - (a) by delivering it to any person who is apparently over the age of 16 years and is apparently residing on, or in occupation of, the land to be entered, or
 - (b) if there is no person available to give the notice to as referred to in paragraph (a), by affixing it in a conspicuous position:
 - (i) at the main point of entry to the land, or
 - (ii) at the main point of entry to a building situated on the land, or
 - (iii) to some other conspicuous object situated on the land.

87 Certificate of authority under section 26 of the Act

A certificate of authority referred to in section 26 of the Act, whether for a land surveyor or a mining surveyor, must be issued by the Surveyor-General in the form of Form 4.

88 Applications to remove survey marks under section 24 of the Act

- (1) An application for an authorisation referred to in section 24 (1) of the Act must be made to the Surveyor-General at least 14 days before the date on which the applicant intends to remove, damage, destroy, obliterate or deface the survey mark in respect of which the authorisation is sought.
- (2) This clause applies only to permanent survey marks and reference marks.

89 Exemption by Surveyor-General

- (1) If the Surveyor-General is of the opinion that it is not practicable or necessary to comply with a requirement of this Regulation in relation to a survey, the Surveyor-General may in writing exempt the surveyor conducting the survey from complying with the requirement.
- (2) A surveyor who obtains an exemption under this clause must record, on any survey plan arising from the survey, the exemption number or type and the clause or clauses to which the exemption relates.

90 Savings provision

Any act, matter or thing that had effect under the *Surveying Regulation 2001* immediately before the repeal of that Regulation by the *Subordinate Legislation Act 1989* is taken to have effect under this Regulation.

Schedule 1 Forms

(Clause 5 (2))

Form 1 Survey certificate

(*Surveying Regulation 2006*—Clause 70)

I, [Insert Name] of [Insert Address], a surveyor registered under the *Surveying Act 2002*, certify that the survey represented in this plan is accurate, has been made in accordance with the *Surveying Regulation 2006* and was completed on: [Insert date of completion of survey].

The survey relates [Specify the land actually surveyed, or specify any land shown in the plan that is not to: the subject of the survey]

Dated:

[Signature]

Surveyor registered under
the *Surveying Act 2002*

Form 2 Certificate as to survey not requiring strict accuracy

(*Surveying Regulation 2006*—Clause 70)

I, [Insert Name] of [Insert Address], a surveyor registered under the *Surveying Act 2002*, certify that the survey represented in this plan (or sketch) was made in accordance with clause 9 of the *Surveying Regulation 2006* and [is/is not]* a survey to be lodged with a public authority as referred to in that clause.

[Signature]

Surveyor registered under
the *Surveying Act 2002*

* Strike out inappropriate words.

Form 3 Notice of entry

(*Surveying Regulation 2006*—Clause 86)

To the occupier of: [Insert reference to land proposed to be entered]

I, [Insert Name] of [Insert Address], in my capacity as [Insert capacity of person concerned, such as “a surveyor” or “an authorised person”], give notice under section 19 of the *Surveying Act 2002* that I intend to enter the land referred to above on: [Insert dates of proposed entry] together with my assistants for purposes relating to the making of a survey.

Dated:

[Signature]

Surveyor registered under
the *Surveying Act 2002*

Form 4 Certificate of authority

(*Surveying Regulation 2006*—Clause 87)

Board of Surveying and Spatial Information

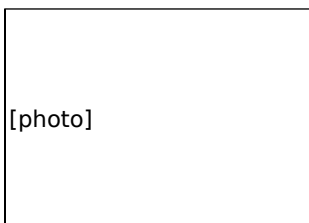

I certify that:
[Name of person]
Identification number:
is [Insert capacity of cardholder, such as “a surveyor” or “an authorised person”] and is authorised to exercise the powers of entry conferred by Part 4 of the *Surveying Act 2002*

Date of issue
DD/MM/YY

Surveyor-General

Schedule 2 Boundary marks

(Clause 27)

Mark	Form or style of mark	Requirements for placement and use of mark
------	-----------------------	--

Peg	<p>Peg of sound durable, hardwood or white cypress pine pointed for about two-thirds of its length or polycarbonate pegs as approved.</p> <p>Rural surveys—At least 450mm long and at least 75mm by 75mm nominal section at the top end.</p> <p>Urban surveys—At least 350mm long and at least 75mm by 35mm nominal section at the top end.</p>	<ul style="list-style-type: none"> • The centre of the top of a peg must represent the survey point except that, if conditions prevent the correct centring of a peg, the survey point may be represented by a non-corrodible tack or nail driven into the peg. • Peg must be placed upright in the ground, point downwards, so that its top is not more than 80mm above the ground level. The earth surrounding it must be securely compacted. • If a peg projecting above the surface of the ground could be hazardous or inconvenient to the public the peg may, at the discretion of the surveyor, be placed flush with the surface of the ground. If that is done, the fact must be noted on the survey plan. • When the depth of soil is insufficient to permit the conventional placement of a peg, then: <ul style="list-style-type: none"> (a) if there is sound rock, a drill hole and wing or chiselled wings must be placed in the rock, or (b) if there is no sound rock, a cairn of rocks must be built around the peg above the surface of the soil.
Drill hole	<p>Drill hole of at least 6mm in diameter and at least 10mm deep.</p>	<ul style="list-style-type: none"> • Drilled into rock, concrete or substantial structure. • If practicable, a chiselled wing must be cut and directed to the mark.
Non-corrodible nail (fixed timber)	<p>Non-corrodible nail at least 65mm long.</p>	<ul style="list-style-type: none"> • Driven completely into fixed timber. • If practicable, a chiselled wing must be cut and directed to the mark.
Non-corrodible nail (concrete)	<p>Non-corrodible hardened steel nail at least 20mm long.</p>	<ul style="list-style-type: none"> • Driven completely into rock, concrete or other substantial material. • If practicable, a chiselled wing must be cut and directed to the mark. • The mark must also be painted.

Non-corrodible rod or spike	Non-corrodible rod or spike at least 150mm long.	<ul style="list-style-type: none"> Only to be used if the placement of a peg is not practicable. Driven flush to the surface.
Star picket	Star picket at least 450mm long.	<ul style="list-style-type: none"> Placed vertically and at least flush with the surface of the ground. “Boundary Mark” token securely attached to timber, post or fence etc by using a non-corrodible nail, spike, rivet or screw.
Boundary Mark token	A non-corrodible token at least 32mm diameter and 1.5mm thick with “Boundary Mark” permanently stamped, engraved or etched on the upper surface.	<p style="text-align: center;">Dimensions in millimetres</p> 
Broad arrow	Broad arrow at least 80mm long, 20mm wide and 10mm deep at the base, pointed at one end.	<ul style="list-style-type: none"> Cut in rock, concrete, substantial structure or fixed timber. Dug or placed in the direction of the boundary lines.
Lockspit	A trench, or line of packed stones, not less than one metre long, 200mm wide, 150mm deep and commencing 300mm from each boundary mark.	<ul style="list-style-type: none"> If the type of soil renders trenches ineffective, direction stakes at least 50mm wide by 30mm thick by 450mm long may be placed in the direction of the boundary lines 4 metres distant from the corner.
Chiselled wing	Chiselled wing at least 80mm long, 20mm wide and 10mm deep at the base, pointed at one end.	<ul style="list-style-type: none"> Cut in rock, concrete, substantial structure or fixed timber. Not to be used by itself as a boundary mark.
Approved mark	A mark of a durable character approved for specific terrain.	<ul style="list-style-type: none"> As approved by the Surveyor-General.

Schedule 3 Reference marks

(Clause 27)

Mark	Form or style of mark	Requirements for placement and use of mark
Permanent Survey Mark	As for the Permanent Survey Marks described in Schedule 4.	<ul style="list-style-type: none"> As specified in Schedule 4.
Drill hole and wing	Drill hole at least 6mm in diameter and at least 10mm deep.	<ul style="list-style-type: none"> Drilled into rock, concrete or substantial structure. A chiselled wing must be cut and directed to the mark. Cut in a substantial structure, fixed timber or the sound wood of a suitable tree. The point of the chiselled wing being the reference point, the chiselled wing to face towards the relevant corner. Placed at a convenient height above ground level. Cut in rock, concrete, substantial structure, fixed timber or the sound wood of a suitable tree.
Chiselled wing	Chiselled wing at least 80mm long, 20mm wide and 10mm deep at the base, pointed at one end.	<ul style="list-style-type: none"> The point of the chiselled wing being the reference point, the chiselled wing to face towards the relevant corner. Placed at a convenient height above ground level. Cut in rock, concrete, substantial structure, fixed timber or the sound wood of a suitable tree.
Broad arrow	Broad arrow comprising of three chiselled wings at least 80mm long, 20mm wide and 10mm deep at the base, pointed at one end.	<ul style="list-style-type: none"> The point of the chiselled wing being the reference point. Faced towards the relevant corner. Placed at a convenient height above ground level.
Metal spike or galvanised iron pipe	Metal spike at least 300mm long. If a solid metal spike, an external diameter of at least 20mm. If a pipe, an internal diameter of at least 20mm and a rim wall thickness of at least 3mm.	<ul style="list-style-type: none"> Placed vertically and at least 80mm below the surface of the ground, or deeper if placed below where fencing is likely to be erected. The specific point must be adequately described.
Specific point	A specific point, on a permanent or substantial structure.	<ul style="list-style-type: none"> If practicable, a chiselled wing must be cut and directed to the mark.

Galvanised star picket	Galvanised star picket at least 450mm long.	<ul style="list-style-type: none"> • Placed vertically and at least 80mm below the surface of the ground, or deeper if placed below where fencing is likely to be erected. • Driven completely into fixed timber.
Non-corrodible nail	Non-corrodible nail at least 65mm long.	<ul style="list-style-type: none"> • If practicable, a chiselled wing must be cut and directed to the mark.
PVC pipe	PVC pipe at least one metre in length and 20mm in internal diameter, made of material with a thickness of at least 3mm.	<ul style="list-style-type: none"> • For use in swampy or marsh areas. • Placed vertically.
Glass bottle	Glass bottle filled with sand, soil, cement or other similar material and at least 200mm long and 30mm in neck diameter.	<ul style="list-style-type: none"> • Placed vertically and at least 80mm below the surface of the ground, or deeper if placed below where fencing is likely to be erected.
Reinforced concrete block	Reinforced concrete block in the form of a truncated pyramid 400mm long, 150mm square (at the lower end) and 100mm square (at the upper end) into the top of which a non-corrodible nail or plug at least 80mm long has been inserted at least 75mm deep.	<ul style="list-style-type: none"> • Placed vertically and at least 80mm below the surface of the ground, or deeper if placed below where fencing is likely to be erected.
Approved mark	A mark of a durable character approved for specific terrain.	<ul style="list-style-type: none"> • As approved by the Surveyor-General.

Schedule 4 Permanent survey marks

(Clause 27)

Type 1 (State Survey Mark)

Examples of monuments

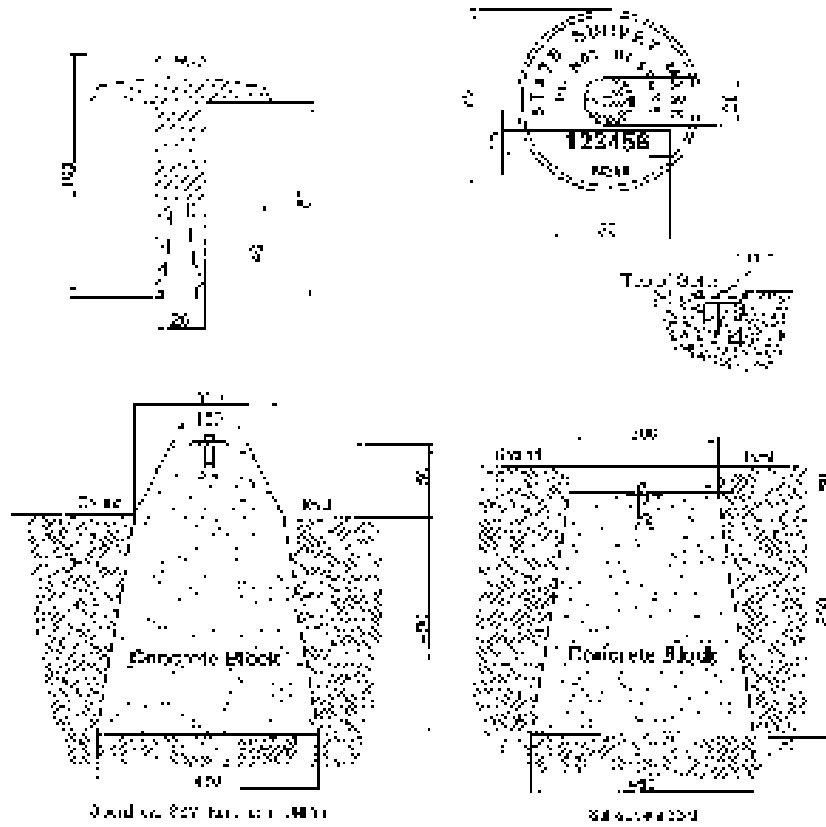

NOTE: When checking that a monument is a solid block, surveyors take care not to be placed in the position where a hole could be drilled. The block used here is a standard size of 100mm x 100mm x 20mm and 100mm diameter hole.

Type 2 (State Survey Mark)

Dimensions are in millimetres

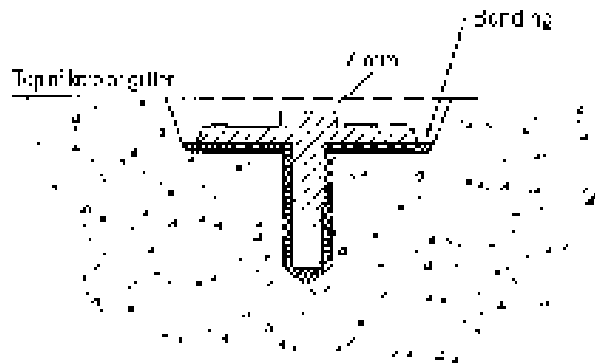
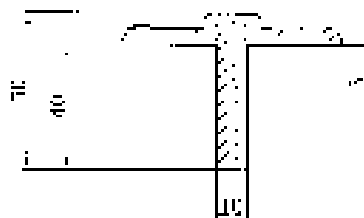
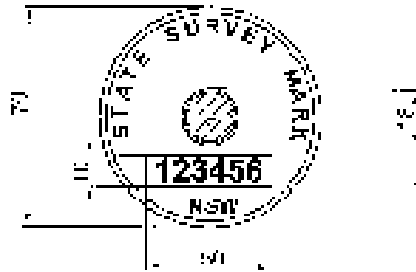

Fixation is by drilling and bonding with a suitable epoxy-resin compound

Type 4 (Urban Type)

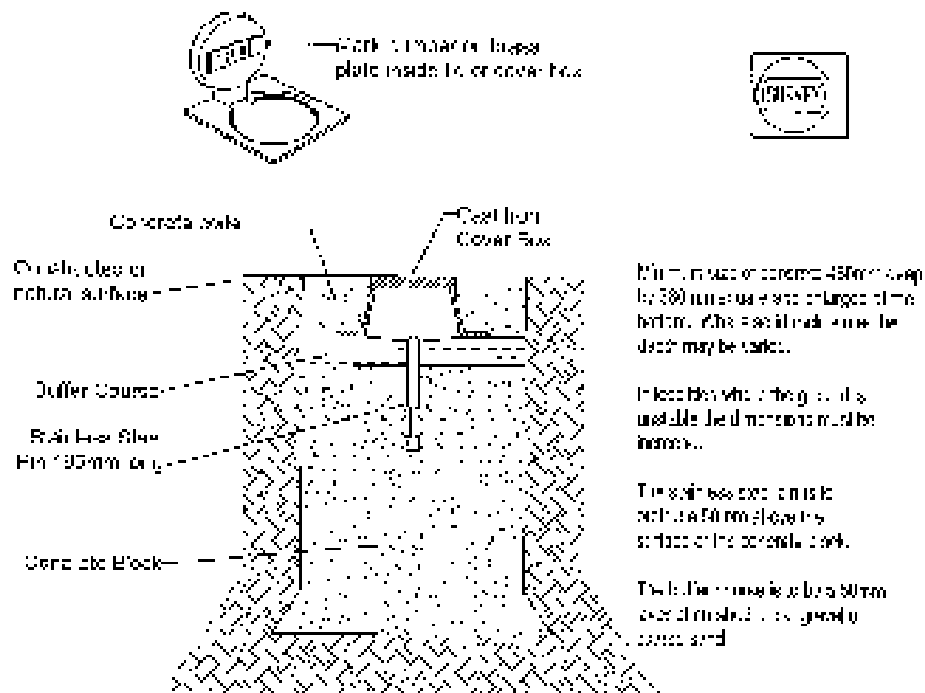

Type 6 (Non Urban Type)

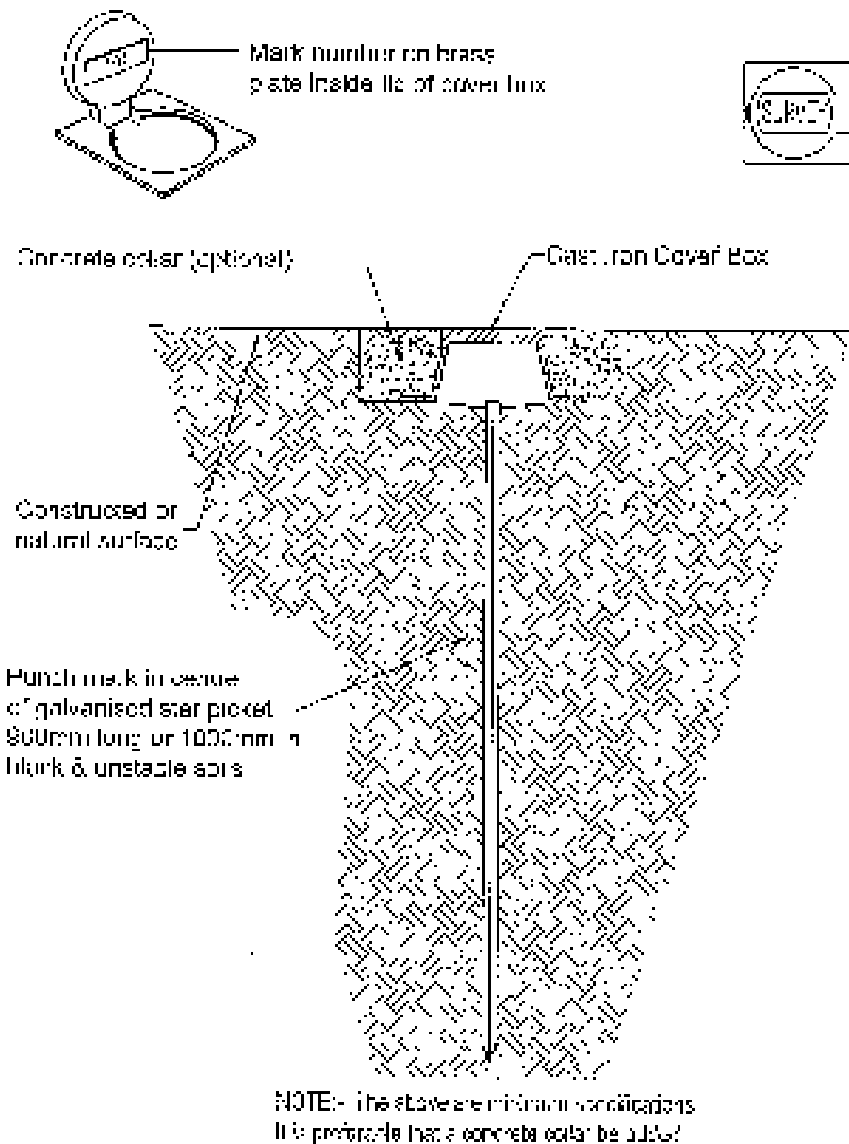

Type 7 (Feno Spike with Cover Box)

Dimensions are in millimetres

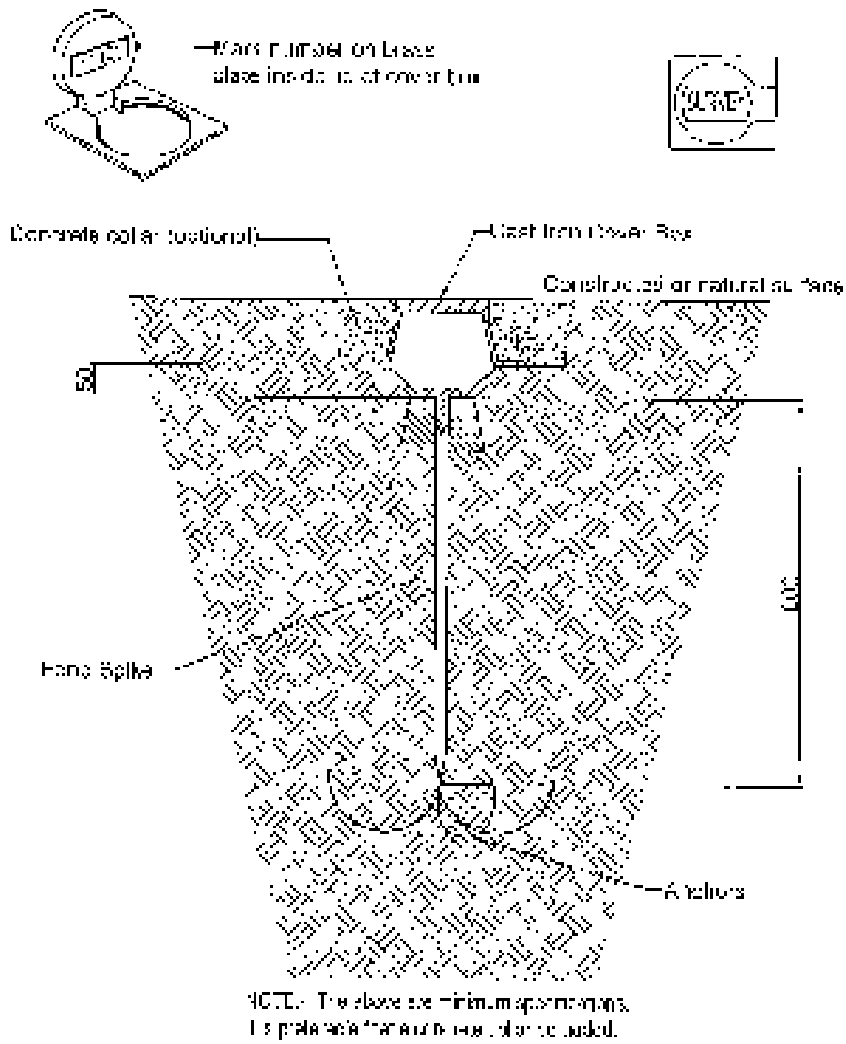

Type 8 (D.W.R. "C-Type" Mark)

Dimensions are in millimetres

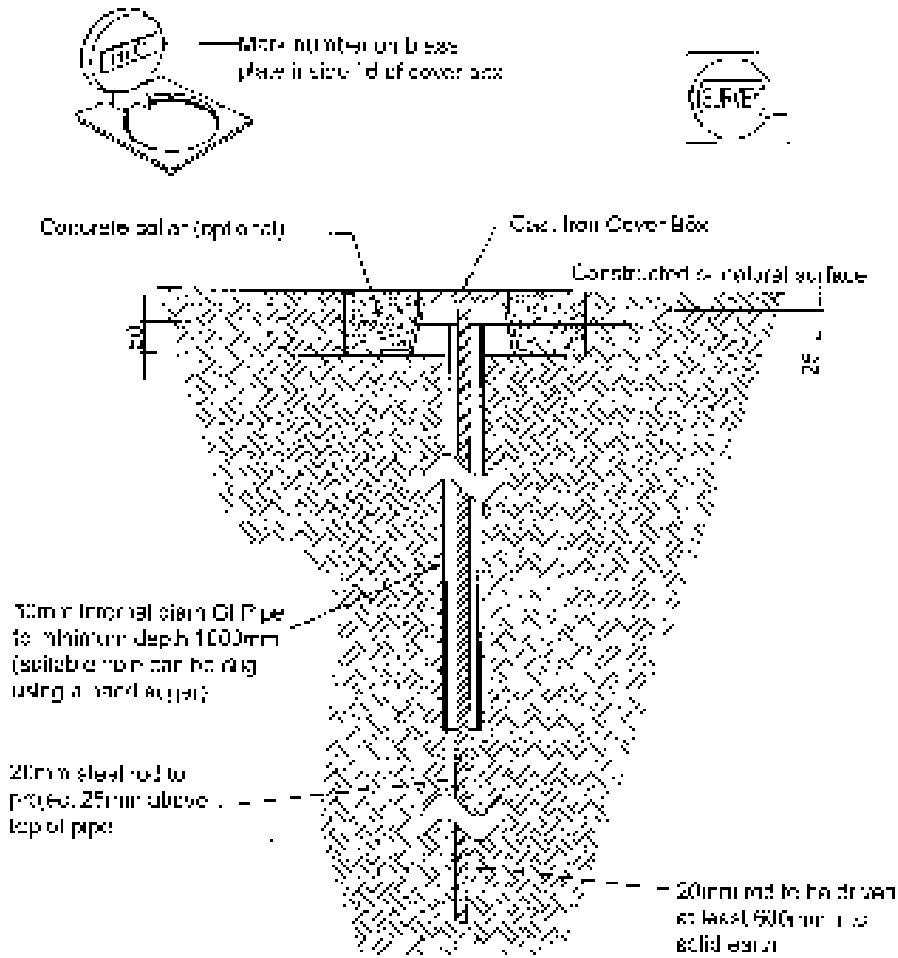

Type 9 (Trigonometrical Station)

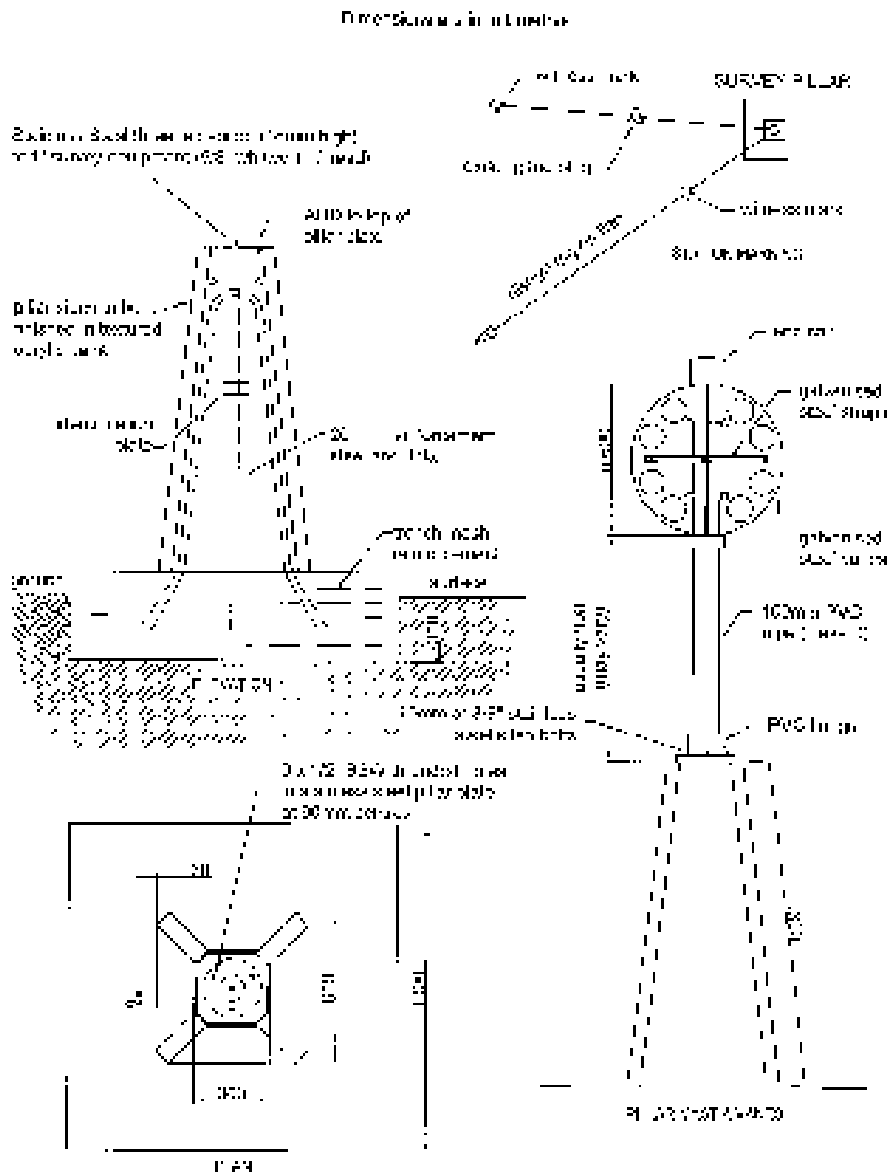

Type 10 (Rooftop Pillar)

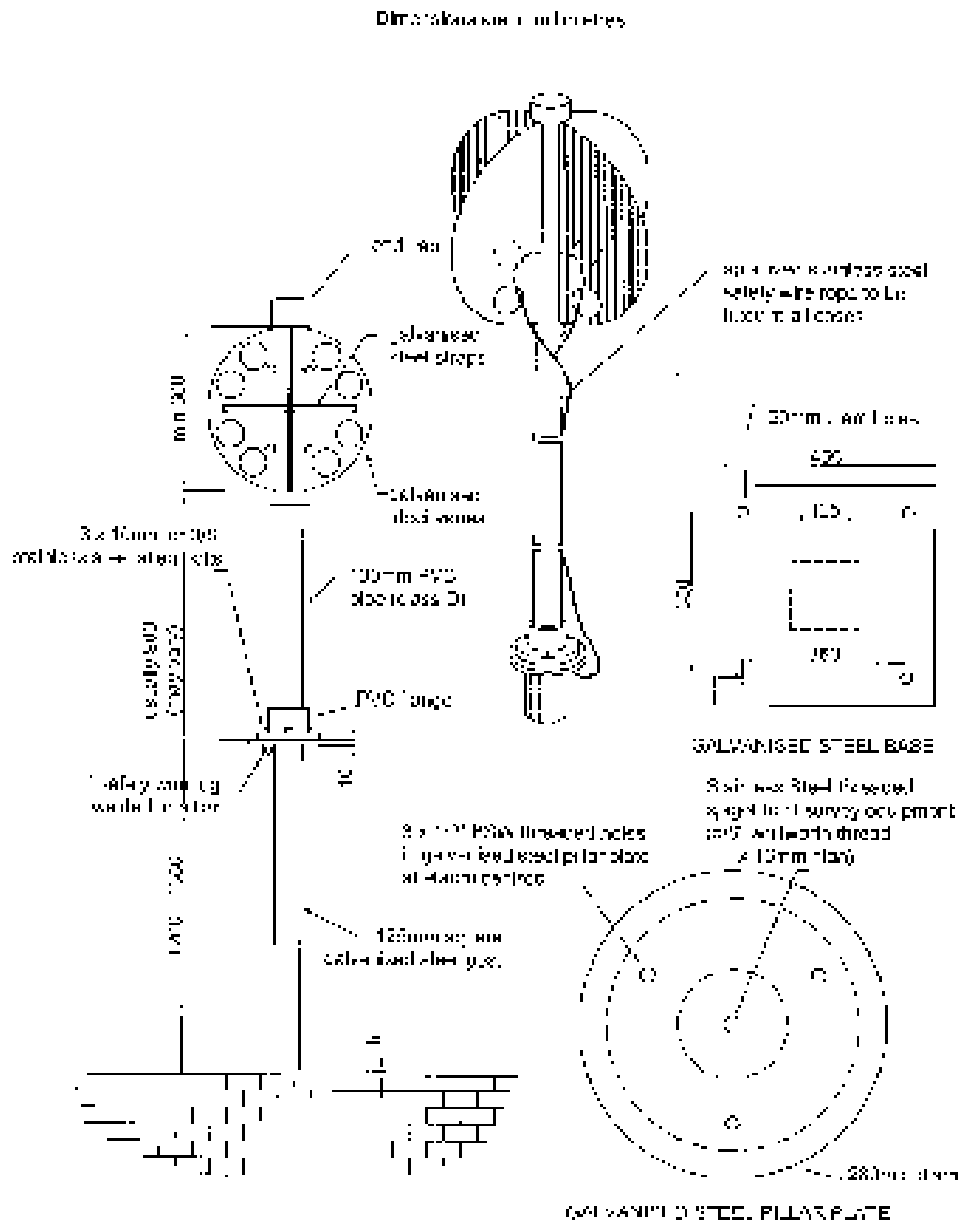













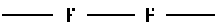

Schedule 5 Conventional signs and symbols

(Clause 68)

Conventional signs and symbols to be used on plans

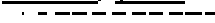
(Boundaries)

State	
Territorial Division	
Local Government Area	
State Forest	
State Recreational Area	
National park, nature reserve or regional park	
State Coal Mine	
County	
Parish	
Public Road	
Surveyed Reserved Road	
Railway	
Track	
Fence on the boundary	
Fence out on the boundary	

(Symbols)

Boundary mark	
Reference mark	
Permanent Survey Mark	
Trigonometric Station	

Schedule 6 Fees and deposits

(Clause 85)

Item	Matter for which fee or deposit payable	Fee/deposit
1	Application to sit for Board examination	\$262 per subject
2	Application to enrol in recognised professional training agreement	\$62
3	Relodgment of application to enrol in recognised professional training agreement	\$31

4	Variation of application to enrol in recognised professional training agreement	\$31
5	Submission of recognised professional training agreement report	\$204
6	Resubmission of recognised professional training agreement report	\$102
7	Final interview (recognised professional training agreement report)	\$204
8	Application for granting of registration	\$62
9	Application for restoration of registration	\$153
10	Application for replacement of certificate of registration	\$62
11	Registration administration fee	\$380 or, in the case of registration as both a land surveyor and mining surveyor, \$250 in respect of each registration
12	Application to inspect register of public surveys	\$26
13	Extract from register of public surveys (per entry)	\$4
14	Extract from register of surveyors (per entry)	\$4
15	Application for certificate of authority	\$82
16	Deposit payable for deferred placement of survey marks	\$765, or \$255 per survey mark, whichever is the greater
17	Application for Board's determination that a person's abilities and experience qualify the person to be a survey drafter or surveyor's assistant	\$82
18	Application to be a student of surveying, survey drafter or surveyor's assistant	\$82